



[When will Rough Science be broadcast on your PBS station?](#)  
[Find local airdates here!](#)



[Read Ellen McCallie's behind-the-scenes diary from Carriacou.](#)

A deserted island. Five scientists.  
Knowledge, ingenuity and resourcefulness their only assets.  
Watch what happens...



[Explore the Challenges](#) | [Solve the Web Challenge](#) | [Meet the Rough Scientists](#)  
[Discover More](#) | [About the TV Series](#) | [Feedback](#) | [Message Board](#)

[Site Map](#) | [Site Credits](#) | [Privacy Policy](#)

Produced By



Made Possible By



*The miracles of science®*

A co-production of the BBC and Open University in association with WETA Washington, D.C. Major funding for *Rough Science* was provided by the [National Science Foundation](#). Corporate funding was provided by [DuPont](#).

This project was supported, in part, by the National Science Foundation. Opinions expressed are those of the authors and not necessarily those of the Foundation.

Copyright © 2002 [The Open University](#) and [WETA](#).



## DISCOVER MORE

Explore the Challenges

Solve the Web Challenge

Meet the Rough Scientists

About the TV Series

Discover More

Feedback

Site Map

Everywhere you look you can see the fruits of scientific effort and technological innovation — from mobile phones to medicines, from the clothes we wear to the foods we eat. In the natural world, science has shed much light on the value and function of plants and animals and the interplay of various life forms and habitats. Scientists have opened our eyes to a startling, exciting and occasionally bewildering universe.

Yet, in spite of the ubiquitous nature of science, many people find science daunting and inaccessible. The **Rough Science** television series and Web site hope to change that. By showing how science can be put to use in everyday life, **Rough Science** helps viewers to understand that science is a process involving some basic knowledge, a good dose of curiosity, a little guesswork, trial and error, and a certain amount of elbow grease to create technological solutions.



[A Brief History of Science](#)

[What is Science all About?](#)

[The Art of Science](#)

### Create Your Own Rough Science Adventures

Targeted to educators, museum professionals, parents and the general public, these science and technology activities are similar to those faced by the scientists in the series. They are designed to encourage collaborative learning and experimentation in an informal setting after viewing each episode.

Download the [Rough Science Adventure Activities Guide](#)

(2.7MB PDF, requires Acrobat Reader)

[Water Quality Control Center](#)

[Weather Station](#)

[Island Power Plant](#)

[Island Observatory](#)

[Island General Store](#)

[Island Restaurant](#)

[Tropical Island Day Spa](#)

[Tropical Island Party](#)

[National Science Education Standards: Grades 5-8](#)

[National Science Education Standards: Grades 9-12](#)

## Additional Resources

[Rough Science Metric Converter](#)

[Books](#)

[Web Sites](#)

[Scientific Supply Companies](#)

Major funding for Rough Science was provided by the [National Science Foundation](#). Corporate funding was provided by [DuPont](#).

Copyright © 2002 [The Open University](#) and [WETA](#).



## DISCOVER MORE

### Water Quality Control Center

Explore the Challenges

Solve the Web Challenge

Meet the Rough Scientists

About the TV Series

Discover More

Feedback

Site Map

That tropical water really looks inviting! Looks can be deceiving. Before you jump in for a swim, do a little rough science to check if that water's as pure as it looks.

#### The Challenges!

- To determine if the water is polluted, test the acidity of the water.
- To determine if the water has a high or low mineral content, test the hardness of the water in a soap solution.
- To see what organisms are in the water, make a microscope.
- To make sure that your drinking water is safe, design and build a water filter.
- To help you to keep an eye on the time, make a water clock.

#### Test the Acidity of Water

We want to know if the water on your island is acidic or basic (alkaline). Strongly acidic or strongly alkaline water can be a sign of pollution and can be harmful to plants and animals and hazardous to drink. Carry out the following test to check your water.

#### You'll need:

- a red cabbage
- medium-size bowl
- grater
- strainer
- small plastic or glass pitcher
- 5 clear plastic cups
- baking soda
- lemon juice
- vinegar
- cola
- distilled water
- "island" water (spiked with something acidic like vinegar)
- teaspoon

#### What you do:

Grate one cup of red cabbage into a medium-size bowl and cover it with 1/2 cup cold distilled water. Let it sit for 45 minutes. When the water turns red, strain the cabbage juice into a plastic pitcher. Use the cabbage juice to test for acids or bases. Acids will make the cabbage juice turn different shades of red, and bases will make it turn different shades of blue.

Pour an equal amount of cabbage juice into five plastic cups. Add 1 teaspoon of baking soda (which is

a base) to four of the cups.. The stronger the acid, the less liquid you'll use to get the original color back. The fifth cup is your control. The color of the juice in the cup with just the baking soda is the color that you want to get all of your mixtures to match.

Add the lemon juice, 1 teaspoon at a time, to your first cup. How much lemon juice did you have to add to get the cabbage juice back to its original reddish color? In the second cup repeat for vinegar, and cola in the third cup. The liquids you need to use the least of are the most acidic. The liquids you need to use the most of are the least acidic. The liquids that don't change the color at all are bases. Now that you have a range of reactions for comparison, test island water in the fourth cup. What is your conclusion? Is it acidic or basic?

### **What's going on?**

Red cabbage juice is an indicator. When it comes into contact with a base, like baking soda, it turns blue/purple. When it's mixed with an acid, like vinegar, it stays red/pink. Pure water is neutral — neither acidic nor basic.

For more information, see **Rough Science** episode 1: "Mapping it Out"

---

## **Test the Hardness of Water**

Water can be "hard," even though it's a liquid. Hard water contains lots of minerals (such as magnesium and calcium) that leave deposits in pans and water pipes. Hard water also makes it difficult to lather up with soap. Are you concerned about the lack of lather when you soap up on the island? Test your water to see how hard it is.

### **You'll need:**

- "island" water
- two screw-top jars
- teaspoon
- eye dropper
- small open jar
- tall drinking glass
- distilled water
- liquid soap
- Epsom salts
- measuring cup

### **What you do:**

In the small jar mix a teaspoon of the liquid soap with ½ cup of the distilled water to make a soap solution. In the tall glass dissolve 1 teaspoon of Epsom salts in 2 cups of distilled water to make hard "island" water. Pour distilled water into one screw-top jar and the same amount of "island" water into the other. Use the dropper to put one drop of soap solution into the jar of island water. Screw the lid on tight and shake. If the water doesn't foam, add another drop of soap solution, screw on the lid, and shake it again. Repeat until the water foams. Count how many drops of soap solution you need. Repeat the experiment using the screw-top jar of distilled water. Which water needed more drops of soap solution to make it foam?

### **What's going on?**

Distilled water is "soft." We can use it as a measure of the hardness—the mineral content—of the "island water." In hard water the salts (magnesium and calcium) interact with soap to form a scum that will not form bubbles (soap foam). Therefore, the amount of lather is related to the hardness of the water.

For more information, see **Rough Science** episode 10: "Sustenance and Sayonara"

## Make a Microscope

Water is full of plants and animals that are too small to see with the naked eye. Make a simple microscope to see if you can detect any tiny organisms swimming around in the water.

### You'll need:

- empty matchbox
- piece of thin, transparent plastic (e.g., from a plastic bag or plastic wrap)
- matchstick
- petroleum jelly or lip balm
- dropper
- scissors
- transparent tape
- water samples (e.g. from an "island" pond)

### What you do:

Cut out most of one of the large sides of the matchbox sleeve. Be careful not to cut it all out since the sleeve still needs to hold together. Next cut a piece of thin, transparent plastic the same size as the end of the sleeve (where the tray slides in). Tape the plastic across the end of the sleeve, taking care to keep the tape right to the edges. Cut a hole in the side of the sleeve to allow light to enter. With the plastic-covered end up, slide the sleeve onto the tray of the matchbox (as if to close the matchbox) with the hole on the open side. Using the matchstick, draw a circle of petroleum jelly on the plastic. Use the dropper to place a single drop of water in the circle. Put another drop of water (pond water) on the end of the tray and look at it through your magnifying water drop. Very carefully, slide the sleeve up or down to focus your microscope. This matchbox setup can also be used to view other items like small insects.

### What's going on?

This is a simple type of light microscope that bends light reflected by an object to make a larger magnified image.

*Activity adapted from "How to Build a Mini Microscope" at <http://physics.about.com>.*

For more information, see **Rough Science** episode 2: "Bugs and Barometers"

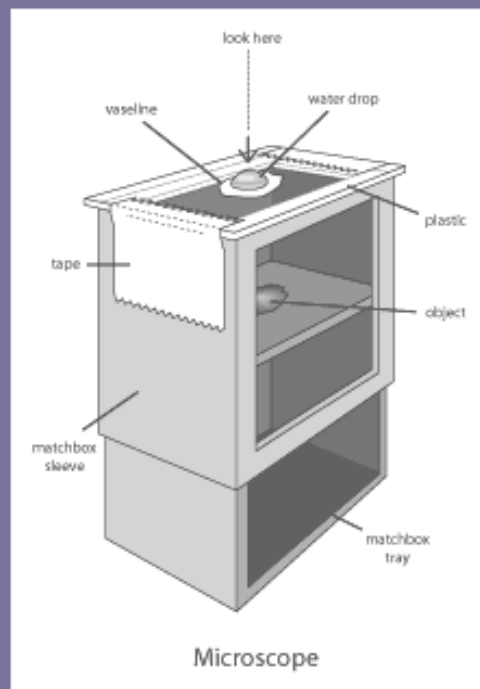

## Build a Water Filter

Worried about the quality of drinking water on the island? Filtering is one of the best methods of making water safe to drink. This filter will remove small particles from dirty water. Make your own filtered water using this method.

### You'll need:

- 2-liter soda bottle with cap
- serrated knife
- napkins or paper towels
- gravel, sand, charcoal, and cotton balls for the filter
- dirty water (if your "island" water looks too clean, add cooking oil, food coloring, pieces of

paper, or tiny pieces of Styrofoam)

### What you do

Remove the plastic sheath from the outside of the soda bottle and screw on the cap. Cut the bottle in half. Put the top half of the bottle upside-down (like a funnel) into the bottom half. Line the upside-down half-bottle with a napkin or paper towel. Put layers of gravel, sand, charcoal, and cotton balls inside the top half of the bottle. (Ask participants to predict what they think each of the filter materials will remove from the water.) Remove the bottle cap. Pour the dirty water through the filter. (Ask participants to comment on any changes they notice and how their observations fit with their predictions.) Now scoop out each layer of the filter and examine what each layer has taken out of the water. Experiment by putting the filter materials into the bottle in a different order each time. What difference does the order of the layers make? Clean the bottle halves thoroughly before you use them again.

### What's going on?

Different materials filter different substances from the water. The slower the water travels through a material, the more impurities are removed. Here the cotton fibers and sand create a longer path for the water and impurities to pass through and solids get trapped. Charcoal particles are charged (like a glass rod rubbed with a silk cloth) and they attract oppositely charged impurities.

For more information, see **Rough Science** episode 2: "Bugs and Barometers"

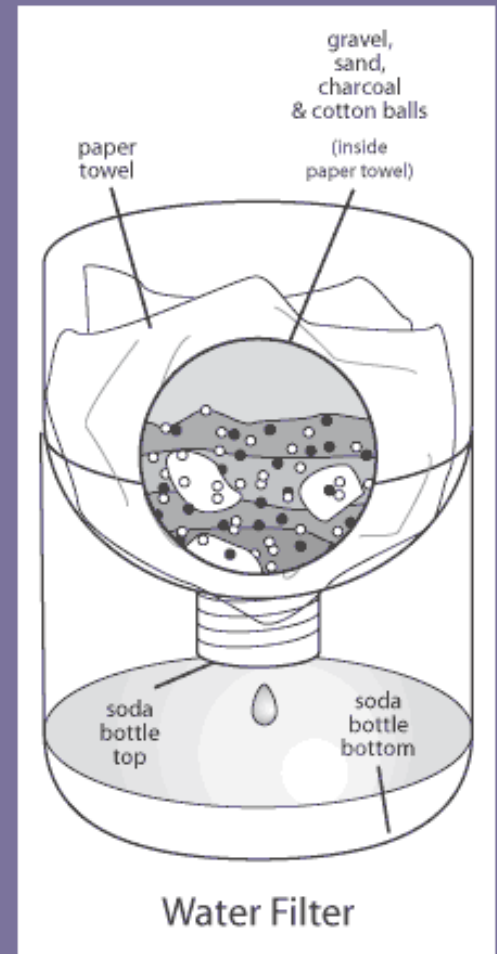

### Make a Water Clock

The island sundial relies on the sun. So how will we know the time after dark or on a cloudy or rainy day? This water clock, based on an ancient Chinese design, will keep you on schedule. It marks time every 5 minutes. Use it to keep your water treatment activities on schedule.

#### You'll need:

- sundial or kitchen timer or alarm watch
- 5 paper cups (all one size)
- clear glass jar at least as big as the cups
- 5 thumbtacks
- transparent tape
- pencil
- strip of heavy cardboard
- strip of paper
- water

### What you do:

Prick a hole in the bottom of each cup with a thumbtack. Pin the 5 cups to the cardboard with the thumbtacks, one cup above the other. Tape the strip of paper vertically on the glass jar; place the jar beneath the bottom cup. (Test the apparatus: fill the top cup with water and make sure the water drips smoothly through each cup down to the glass jar, then empty the water from the cups and jar.) Fill the top cup. Using your sundial or other timepiece, every 5 minutes mark the water level in the glass jar on the strip of paper. When the glass jar is full, you will know how much water represents a five-minute interval. Now you can use the water clock to keep track of time.

### What's going on?

The water clock measures time against a known scale of five-minute intervals. This not unlike a sand timer that has been calibrated to take a period of time to move from the top to the bottom.

*For information on making other types of water clocks, see <http://nationalgeographic.com/world/trythis/try10.html>.*

For more information, see **Rough Science** episode 3: "Time and Transmitters"

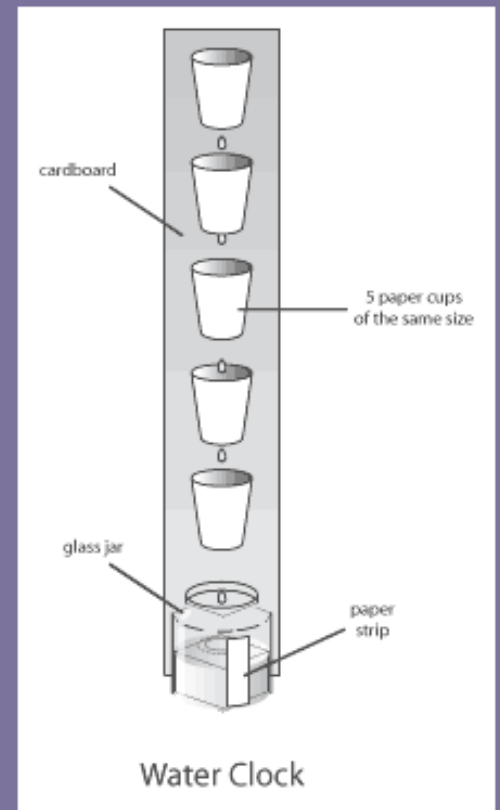

[Discover More main page](#)

Major funding for Rough Science was provided by the [National Science Foundation](#). Corporate funding was provided by [DuPont](#).

Copyright © 2002 [The Open University](#) and [WETA](#).





[PBS Home](#)

[Search](#)

[Programs A-Z](#)

[TV Schedules](#)

[Shop](#)

[Membership](#)

**Station  
FINDER**

Find Your Local PBS Station

To find a station, either enter a zipcode or choose by state.

Enter your zipcode:

\_\_\_\_\_ or \_\_\_\_\_

Note: The zip code tool does not support province or state codes for viewers outside the United States - please use the states and territories pulldown menu to locate your PBS station.

Need Help? Check  
the [Station Finder  
FAQs](#)



What's On Tonight?  
Get your local PBS TV  
Schedule:

Zip  
code:

Previews  
Get a sneak peek at  
shows [coming soon to  
PBS.](#)

Stay tuned in to PBS  
with the weekly [PBS  
Previews newsletter.](#)



Like a book club, but  
for TV.

[PROGRAMS A-Z](#) Explore

[SEARCH](#)

[SHOP](#)

◀ [American Experience: Seabiscuit](#)  
Learn how this remarkable thoroughbred racehorse became the champion of an America in the grip of the Great Depression.  
[More History](#) ⋮→

[Support your local PBS station.](#)  
It's auction time! Bid on thousands of terrific items both on-air and online as a way of supporting your local PBS station.

[ExxonMobil Masterpiece](#) ▶

[Theatre: The Jury](#)  
Go behind the scenes of this emotionally intense courtroom drama.  
[More Arts](#) ⋮→



[PBS Parents](#)  
Advice and activities for raising a PBS kid



◀ [Nature: Leopards of Yala](#)  
Get up close and personal with these spectacular spotted cats.  
[More Nature](#) ⋮→

[TeacherSource](#)  
Free lesson plans, professional development and more for preK-12 educators

[Young Dr. Freud](#)  
Explore the events and people that influenced the father of modern psychology.  
[More Science](#) ⋮→

[PBS Campus](#)  
Courses and colleges to continue your education

[I, Cringely](#)  
Apple Records has a familiar ring to it, but won't happen anytime soon, says übergeek Robert X. Cringely — and here's why.  
[More Science](#) ⋮→



[SHOP  
PBS](#)  
Order  
[American Experience:  
Seabiscuit \(DVD\)](#)

[Focus On ...](#)  
[Iraq](#)  
Get analysis of and perspective on the war in Iraq with these PBS resources.

[npr](#) **Headlines**

[Hourly newscast](#)

[NewsHour Reports](#)

[Four Top Iraqi Leaders Captured](#)

[Garner Arrives to Rebuild Iraq](#)

[U.S. Iraq Administrator Arrives in Baghdad](#)

[German-U.S. Relations](#)

[Beijing Mayor Fired After SARS Disclosure](#)

[Station Finder](#) | [About PBS](#) | [About this Site](#) | [Become a Member](#) | [PBS YOU](#) | [Wireless PBS](#) | [Sponsor PBS](#)  
[Producing for PBS](#) | [Satellite Changes](#) | [Privacy Policy](#) | [Feedback](#)



## Search and SITEMAP

### PBS Online Search

Enter a phrase or sentence below and then click on one of the search buttons.

### Other Search Tools

[Programs A-Z list](#): Looking for a site mentioned on TV? Check this comprehensive list.

[ShopPBS search](#): Locate videos, CDs, books, and other PBS gift items.

[TeacherSource search](#): Find everything from educator resources to national and state curriculum standards.

[Site Map](#): Still lost? Perhaps our site map can help.

### Site Map

- [Homepage](#)
- [Programs A-Z](#)  
(Complete list of PBS Web sites, from "The American Experience" to "ZOOM".)
- **Explore PBS**  
PBS features are grouped by these categories:
  - [Arts](#)
  - [Business & Finance](#)
  - [Games & Diversions](#)
  - [Health & Religion](#)
  - [History](#)
  - [Home & How-To](#)
  - [Nature & Wildlife](#)
  - [News & Views](#)
  - [Science &](#)
- [TV Schedules](#)
- [PBS Previews](#)  
(subscribe to our e-mail newsletter)
- [Picks of the Month](#)
- [Satellite Schedule](#)
- [Station Finder](#)  
Get TV listings and community information from your local PBS station
- [About This Site](#)
- [Feedback](#)
- [Frequently Asked Questions \(FAQs\)](#)
- [Press Releases](#)
- [Privacy Policy](#)
- [Program Contacts](#)
- [Rules of the Road](#)

[Search NPR](#)  
National Public Radio

our sponsors



[Technology](#)

- [Travel & Expeditions](#)
- [PBS Kids](#)
- [TeacherSource](#)  
(for educators)
- [Adult Learning Service](#)
- [\*\*Shop PBS\*\*](#)  
Videos, CDs, books, and more
- [Shop Privacy Policy](#)
  
- [\*\*PBS Video\*\*](#)  
Videos for the classroom

- [Site Awards and Reviews](#)

- [Sponsorship](#)
- [Technology Alliance Partners](#)
- [\*\*About PBS\*\*](#)
- [PBS News](#)
- [Corporate Facts](#)
- [Local Station Directory](#)
- [Become a Member](#)
- [Annual Report](#)
- [Job Openings](#)
- [Internships](#)
- [Sponsorship Opportunities](#)
- [Industry Partners](#)

[\*Back to Top of Page\*](#)



## DISCOVER MORE

### Weather Station

Explore the Challenges

Solve the Web Challenge

Meet the Rough Scientists

About the TV Series

Discover More

Feedback

Site Map

The weather in the tropics can be unpredictable. And there's no radio or TV station to turn on and get a reliable forecast. That's why you'll need a weather station to figure out what changes lie ahead. You'll want advance warning if that big storm is on the way. And you'll want to know which direction it's coming from.

#### The Challenges!

- To calculate the moisture content of the air, [find the dew point](#).
- To predict changes in the weather, [make a barometer](#).
- To find out which way is North, [construct a compass](#).
- To determine the wind direction, [build a wind vane](#).

#### Find the Dew Point

The island climate is completely different from the one you're used to. How do you avoid getting caught in a torrential storm or a thick fog? The dew point is the temperature at which moisture in the air begins to form dew. It is a way of gauging the air's humidity. Here's a way to calculate it.

#### You'll need:

- tin can
- thermometer
- tablespoon
- ice cubes
- paper towel
- bowl
- water

#### What you do:

Crush the ice cubes in the paper towel using the back of the tablespoon. Fill the bowl halfway with crushed ice. Make sure the outside of the tin can is completely dry. Fill the can with cold water. Place the thermometer in the can. Add one tablespoon of crushed ice and stir. Continue adding ice until a layer of dew is visible on the outside of the can. Immediately read the thermometer to find the dew point temperature. If it's high, beware! The humidity is high also.

#### What's going on?

All air contains water vapor. As air cools (when it comes in contact with the cold can), the water vapor begins to condense. This is why glasses holding cold drinks "sweat" in the summertime. The dew point is the temperature at which moisture in the air begins to form dew. The higher the dew point temperature, the higher the moisture content of the air at a given temperature.

*Activity adapted from Robert Wood. Science for Kids: 39 Easy Meteorology Experiments. TAB Books, 1991.*

For more information, see **Rough Science** episode 2: "Bugs and Barometers"

### Make a Barometer

A barometer shows changes in air pressure. High pressure indicates good weather, low pressure indicates possible storms. By consulting your barometer every day, you'll be able to make predictions about weather changes. (This can be a multi-day activity to compare the daily differences in air pressure.)

#### You'll need:

- tall glass or jar
- bowl
- 4 paper clips
- pen
- water

#### What you do:

Slide the paper clips onto the rim of the glass and space them equally around the rim. Fill the glass about two-thirds full with water. Place the bowl upside down over the glass. Carefully turn the bowl and the glass over so that the glass sits upside down in the bowl. Some of the water will run out of the glass but most will stay inside it. With a pen mark the level of the water in the glass at the beginning of the activity. Take your barometer outside into the open air. Look for changes in the water level in the glass over time. (This may take several hours or even longer than a day.)

#### What's going on?

When the atmospheric pressure of the air rises, the water in the bowl will be forced downwards by the weight of the air on the water. This, in turn, will cause the water in the glass to rise. A barometer measures the weight of the amount of air between the surface of the earth (the water in the bowl) and the top of the atmosphere.

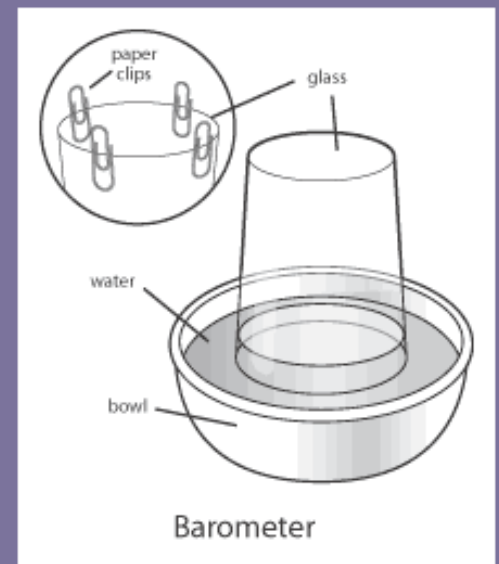

*Activity adapted from Robert Wood. Science for Kids: 39 Easy Meteorology Experiments. TAB Books, 1991.*

For more information, see **Rough Science** episode 2: "Bugs and Barometers"

### Make a Compass

Make a compass to determine the different directions: North, South, East, and West.

#### You'll need:

- needle
- magnet
- plastic container
- a cork (1/4" to 1/2 " thick)
- pen
- water

### What you do:

Fill the plastic container with water. Stroke one end of the magnet along the needle in one direction at least 50 times to magnetize the needle. Lay the needle on the cork, with one end of the needle in the center. Tape the needle down. Float the cork in the container of water. The needle will bob around until it points North, towards the Earth's magnetic north. When the needle settles in position, mark North on the side of the container. Now you can determine the other directions and label them East on the right, South on the bottom and West on the left.

### What's going on?

The Earth's core is thought to consist largely of molten iron, which crystallizes into a solid. Convection caused by heat radiating from the core, along with the rotation of the Earth, causes the liquid iron to move in a rotational pattern. It is these rotational forces in the liquid iron layer that lead to weak magnetic forces around the axis of spin. The magnetized needle in a compass can detect very slight magnetic fields. No matter where you stand on Earth, you can hold a compass in your hand and it will point toward the North. This is amazingly helpful because you can tell which way to go no matter what the weather or time of day.

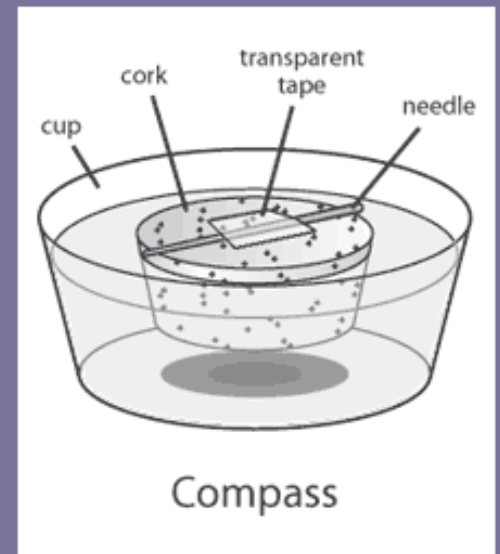

For more information, see **Rough Science** episode 3: "Simmering Shutterbugs"

---

### Build a Wind Vane

A change in wind direction often indicates an imminent change in the weather. Be prepared for sudden change by making this wind vane. (You can also use the compass you made in the previous activity to identify the direction of the wind.)

#### You'll need:

- a long tack
- scissors
- modeling clay
- a plastic pot or container, e.g., from take-out food
- ruler
- glue stick
- thin, colored card
- drinking straw
- 2 pencils with eraser
- compass



**What you do:**

Turn the plastic container upside down. Make a hole in the center by inserting the pencil, sharp end first. Make sure that it is firmly in place. With another pencil and a ruler, draw two large triangles and four small ones on the colored card. Then cut out the shapes. Glue the small triangles to the base of the plastic container at equal distances and on opposite sides from each other as on a compass. One point of each small triangle should overlap the edge of the pot, with the pencil in the middle. Cut short slits in each end of the straw and insert one large triangle in each end to make an arrow-shaped "vane." Push the tack through the center of the straw and into the eraser on the pencil sticking out of the pot. Secure the other end of the pot to a surface with a ring of modeling clay. Take the vane outside or to a simulated windy weather area and watch it swing in the wind. Finally, use your compass to determine East, West, North and South, and then label the small triangles accordingly. Now you can tell which direction the wind vane is pointing.

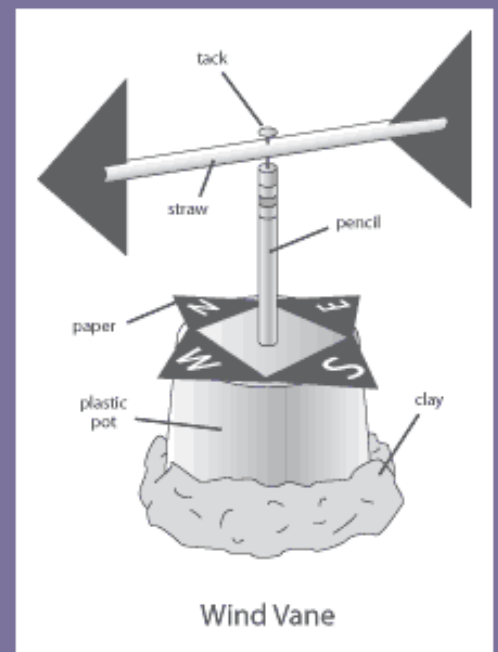
**What's going on?**

The direction in which the vane points indicates the direction from which the wind is blowing. For instance, in a westerly wind, the vane points "West."

*Activity adapted from Neil Ardley. 101 Great Science Experiments. Dorling Kindersley, 1993, pp. 14-15.*

For more information, see **Rough Science** episode 2: "Bugs and Barometers"



[Discover More main page](#)

Major funding for Rough Science was provided by the [National Science Foundation](#). Corporate funding was provided by [DuPont](#).

Copyright © 2002 [The Open University](#) and [WETA](#).



## DISCOVER MORE

### Island Power Plant

Explore the Challenges

Solve the Web Challenge

Meet the Rough Scientists

About the TV Series

Discover More

Feedback

Site Map

Once you've taken care of basics like food and water, you'll want to experiment with ways to create your own electricity and electrical gadgets. Why don't you employ a little rough science to create a power plant on your island?

#### The Challenges!

- To power things, [make your own battery](#).
- To drive a paper windmill to create a breeze, [build an electric motor](#).
- To see things at night, [make your own flashlight](#).
- To warn others of potential danger, [create a buzzer](#).

---

#### Make a Battery

Some kinds of batteries produce electricity by a chemical reaction between two different metals (electrodes) immersed in acid (electrolyte). Figure out how to make your own batteries in case the limited supply on the island runs out.

#### You'll need:

- two wires with the ends stripped off
- aluminum foil
- scissors
- small bowl
- warm water
- salt
- tape
- 6 pennies (copper coins)
- paper towels
- 1.5 volt penlight light bulb
- a paper plate

**What you do:**

Partially dissolve 1 tablespoon of salt in 1 cup of warm water. Some salt should still be evident in the bottom of the bowl. Place a penny on the aluminum foil and draw around it. Repeat five times. Do the same thing with the paper towel. Cut out the circles. You should have six foil circles and six paper ones. Tape the end of one wire to a foil circle. Dip a paper circle in the warm, salty water. Place the foil circle with the wire on the plate, and put a wet paper circle and a penny on top of it. Using all the foil, pennies, and paper circles, build alternate layers. Then tape the other end of the wire to the last coin and put it on top. This is your battery.

Test the battery with the light bulb. Attach the end of one wire to the metal terminal end of the light bulb. Wrap the end of the other wire around the metal shaft of the light bulb. Can you see the bulb light up?

**What's going on?**

The metal atoms in the foil dissolve into the electrolyte (the warm, salty water) and electrons are left behind. Electricity is created when the electrons flow through a circuit (the foil circles and paper circles soaked in warm, salty water).

When the metals eventually dissolve completely into the electrolyte, no more electrons are formed and the battery stops working. The first battery (Volta's Pile) was developed about 1860 by Alessandro Volta. He stacked discs of copper, zinc, and cardboard soaked in salty water in alternate layers and measured an electronic current.

*Activity adapted from Neil Ardley. 101 Great Science Experiments. Dorling Kindersley, 1993. For instructions on creating a similar battery, see [http://www.exploratorium.edu/snacks/hand\\_battery.html](http://www.exploratorium.edu/snacks/hand_battery.html).*

For more information, see **Rough Science** episode 5: "Sun and Sea"

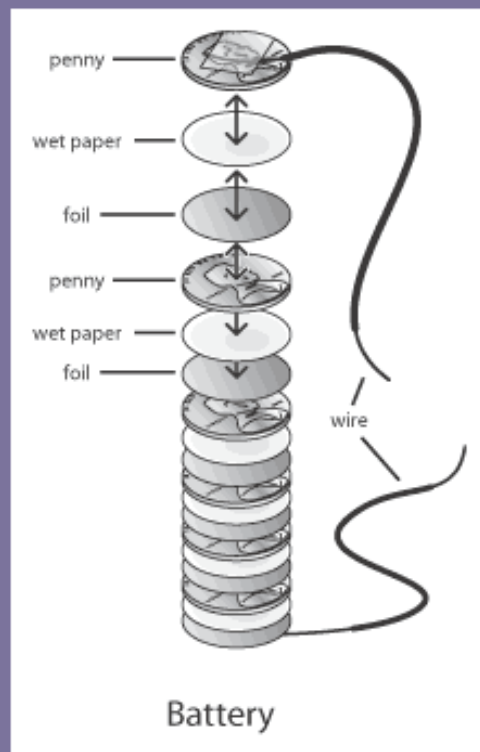
**Build an Electric Motor**

It's hard to sleep at night because of the heat. How would you go about building a simple motor to turn a paper windmill and create a breeze? When a current passes through a coil of wire it turns the wire into an electromagnet which interacts with a permanent magnet to make the coil spin. The spinning coil is a basic motor.

**You'll need:**

- 5 small magnets (available at electronics stores)
- 2 large paper clips
- plastic, paper, or foam cup
- 2 feet of solid insulated 20-gauge copper wire (non stranded)
- masking tape
- a 1.5 volt D cell battery in a battery holder
- 2 alligator clip leads (available at electronics stores)
- wire strippers
- broom

**What you do:**

Wind the copper wire around the end of a broom handle to create a coil with a 1-inch diameter. Take each end of the wire and wrap it around the coil to hold the coil together. Leaving about 2 inches of wire sticking out from each end, strip the insulation off these two ends using wire strippers. Attach three magnets to the bottom of the cup with masking tape. Turn the cup upside-down and lay two magnets on top. (The magnets underneath create a strong magnetic field and keep the magnets on top in place with no tape.) Unfold one end of a paper clip and tape it to one side of the cup so that the rest stands up above the cup. Unfold the other paper clip, and tape it to the other side of the cup. The paper clips will form a cradle for the coil. Attach one end of the coil to one paper clip and the other end of the coil to the other paper clip. Spin the coil and adjust the height of the paper clips to make sure that there is around 1/16 of an inch between the coil and the top of the magnets. Adjust the clips to make sure the coil stays balanced and centered. Put the battery and battery holder beside the cup. Attach one end of an alligator clip to a battery terminal and the other to a paper clip. Attach the other alligator clip to the other battery terminal and the other paper clip. Spin the coil to start it turning.

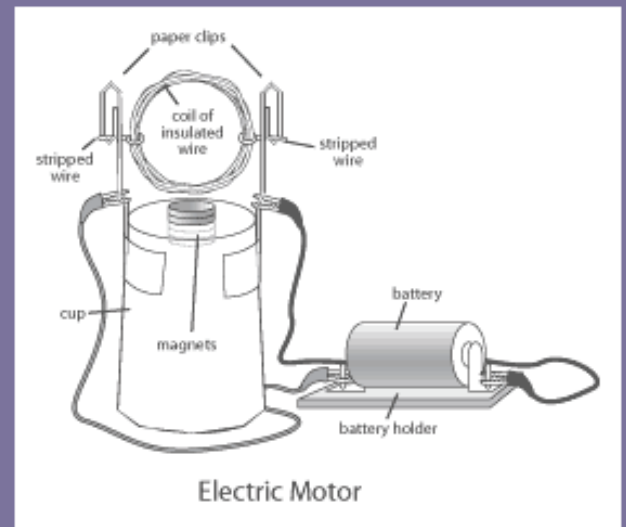
**What's going on?**

The current running through the coil of wire creates an electromagnet. What does this mean? As with a bar magnet, one end of the coil has become a North Pole, and the other a South Pole. Each of the three magnets attracts its opposite pole and repels its like pole of the coil, causing the coil to spin.

For more information, see **Rough Science** episode 5: "Sun and Sea"

**Make a Flashlight**

When you're on the island, you can't just flick a switch and turn on a light. There isn't a constant electricity supply. But with a flashlight, you'll be able to see around your room at night and even venture outside for a walk — moonlight or no moonlight.

**You'll need:**

- 2 batteries with 1.5 volts each
- 2 brass paper fasteners
- sharp pencil
- screwdriver
- aluminum foil
- plastic tape
- a light bulb in a bulb holder
- 3 pieces of wire with bare ends
- paper clip
- cotton
- empty dishwashing liquid bottle
- scissors

**What you do:**

Cut the top off the empty dishwashing liquid bottle. Tape foil shiny side up to the inside of the bottle top. Use the pencil to make two small holes in the side of the bottle near the bottom. One hole should be about an inch below the other. Firmly attach two pieces of wire to the bulb holder. Tape the top of one battery to the bottom of the other to make one long battery. Tape the third piece of wire to the bottom of the battery. Tape one of the wires from the bulb-holder to the exposed terminal on the battery. Put the long battery in the bottle, carefully threading the wire from the bottom battery through the lower hole. Stuff cotton in the space between the batteries and the walls of the bottle to keep the batteries in place. Thread the wire from the bulb-holder through the top hole in the bottle. Attach paper fasteners to the two wires poking through the holes and push in the fasteners. Put the bulb-holder on top of the battery and tape the center of the bottle top over the bulb. In other words, put the bottle top on back-to-front so that the aluminum foil is visible. Bend the paper clip and fit one end under the lower paper fastener to make a switch.

(When the switch is turned, current flows from the battery along the wires to the bulb.) Press the other end of the paper clip against the top fastener and see the flashlight light up.

**What's going on?**

There is a thin wire (a filament) inside the bulb that glows white-hot when current flows through it. The light reflects off the foil to produce a bright beam of light.

For more information, see **Rough Science** episode 5: "Sun and Sea"

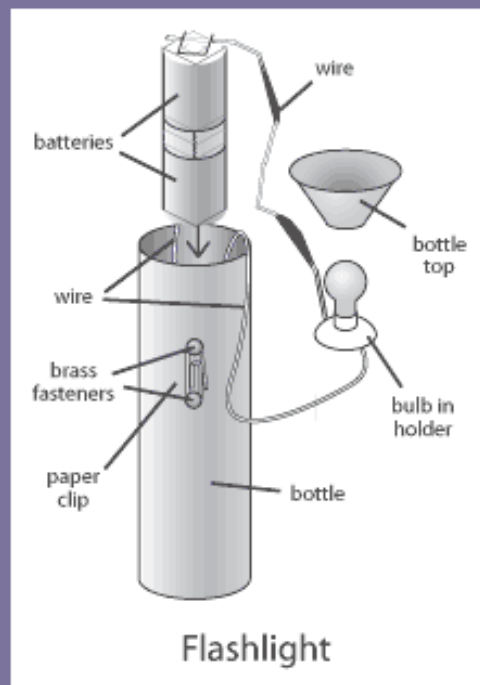
**Create a Buzzer**

The island can be a spooky place, especially at night. Since there is no phone system, you can't call for help if there's a problem. You can, however, create your own alarm system. Try using an electromagnet to make a buzzer!

**You'll need:**

- 9 feet of PVC-covered wire with both ends stripped
- iron or steel bolt
- modeling clay
- an empty thread spool
- steel nail file
- rubber band
- scissors
- plastic tape
- thick cardboard
- soda can
- switch
- 4.5 volt battery

### What you do:

Firmly wrap the wire around the bolt 200 times (leaving both ends of the wire loose). Use the clay to fix the bolt to the cardboard. Turn the spool on its side and attach the handle of the nail file to it with the rubber band. Using the scissors, scrape away the paint at the base of both sides of the can. Tape one end of the wire to the metal part of the nail file, and attach the spool to the cardboard with clay. Cut the two wires. Attach one end to the battery and the scraped part of the can, and the other to the battery and the switch. Stick the can to the cardboard with modeling clay and touch the other scraped part of the can with the nail file. Connect the switch and press it. The can gives off a loud buzz. The vibrating nail file repeatedly strikes the can. Both the buzz and the nail file stop when you release the switch.

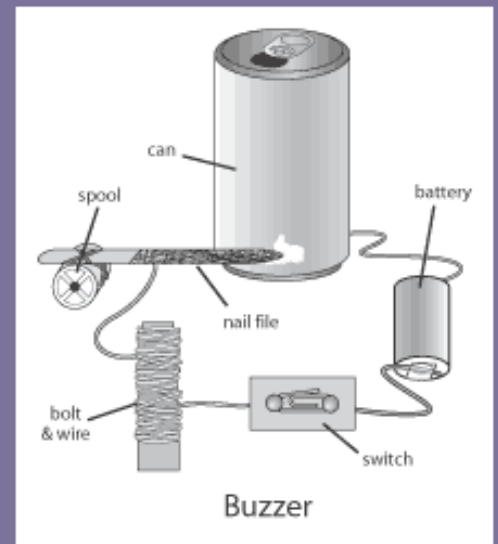

### What's going on?

The buzzer uses magnetism to make a loud sound. Electricity flows from the battery through the can and into the nail file. Every time the nail file hits the can, electricity flows through it to the electromagnet formed by the bolt and wire, through the switch, and back to the battery. The electromagnet pulls the file away from the can. As a result, the electricity stops, and the nail file springs back, striking the can again and setting everything in motion once more. It's the movement of the electromagnet that makes the buzzing sound.

For more information, see **Rough Science** episode 5: "Sun and Sea"

---

### Suggestions for other activities:

- To communicate with other people, make a telegraph.
- To see how much power you have, build a charge detector.
- To check for materials that act as conductors, create an electricity probe.



[Discover More main page](#)

Major funding for Rough Science was provided by the [National Science Foundation](#). Corporate funding was provided by [DuPont](#).

Copyright © 2002 [The Open University](#) and [WETA](#).



## DISCOVER MORE

### Island Observatory

Explore the Challenges

Solve the Web Challenge

Meet the Rough Scientists

About the TV Series

Discover More

Feedback

Site Map

On the island, far away from polluting lights and smog of the city, you check out the spectacular night sky. Using a little rough science, study the solar system while you enjoy the solitude.

#### The Challenges!

- To calculate time at night, [make a star clock](#).
- To identify what's in the night sky, [make a telescope](#).

#### Make a Star Clock

It's night and you want to figure out the time by reading the positions of the stars. Before the invention of clocks, people told the time by the movement of the stars across the night sky. You can do the same using your star clock.

#### You'll need:

- [star clock template](#)
- scissors
- brass paper fastener
- sharp pencil

#### What you do:

Carefully cut around each star clock circle and poke a hole through the middle of each one. Place the small circle on top of the large circle. Push a paper fastener through the holes in both circles and spread the fastener open on the back of the clock. Go outside, look up at the sky, and using your star clock find the Big Dipper and the North (or Pole) Star. Face the North Star. Put your thumb over the current month. Slide the outer circle around so that your thumb is at the top. Turn the smaller disc carefully until its stars line up with those in the sky. You can now read the time in the window. (If you are on Daylight Savings Time, add one hour.) Compare the time with your wristwatch to see how close you get. It's better to do this activity when the moon is not full. A full moon is so bright that it becomes difficult to see the stars.

#### What's going on?

The North Star never appears to move because the Earth's axis, the imaginary line drawn from pole to pole through the center of the Earth, points almost directly to the North Star. The stars that appear to revolve around the North Star are known as circumpolar stars. In mid-northern latitudes, these stars appear to circle around the North Star without rising or setting. The star clock estimates the time based on where the stars appear relative to the North Star.

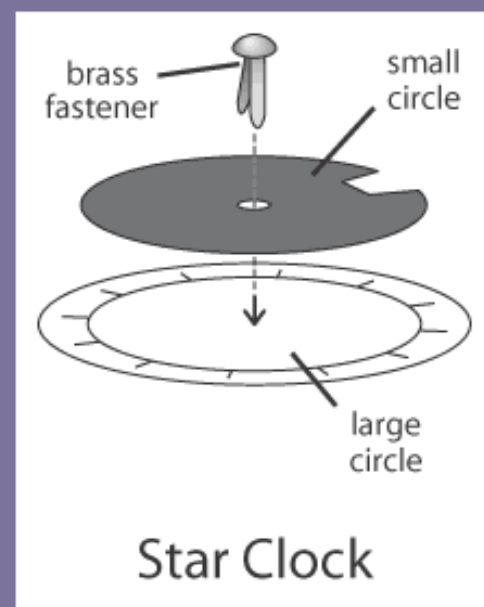

*Activity adapted from Lawrence Hall of Science. Earth, Moon, and Stars. Regents of the University of California, 1986.*

For more information, see **Rough Science** episode 7: "Mediterranean Mystery"

### Make a Telescope

When you first look up to find the Big Dipper to orient your star clock, you may have trouble seeing it. Why don't you make sure you'll find it by making your own telescope? Even if you find the Big Dipper and the North Star with ease, your telescope will help you to see the moon and thousands of other stars in much greater detail.

#### You'll need:

- 2 convex lenses of different focal lengths (e.g., use 2x and 4x lenses from drugstore reading glasses)
- a cardboard tube at least as long as the sum of the two focal lengths of the lenses
- pen
- tape

#### What you do:

Fix one lens to each end of the tube with tape. Take care not to obscure the view through the tube. Mark the end of the tube with the shorter focal length lens. This will help you figure out which way round your telescope is. Look through this end.

#### What's going on?

Telescopes use lenses to bend the incoming light. The first lens (objective lens) gathers light and bends it into focus and provides a small, upside down image of the object you're looking at. The second lens (the eyepiece) then magnifies the object so that you can see it better. When the two lenses are combined, you have a telescope that magnifies the image.

For more information on how telescopes work, see [www.howstuffworks.com](http://www.howstuffworks.com).

#### Suggestions for other activities:

- To understand the position and distance of different planets and the sun, make a model of the solar system.
- To understand the rising and setting of the sun at different points on the Earth, make a solar calculator.
- To measure the height of celestial objects in degrees, make a clinometer.
- To track the stars that you see, make a constellation chart.

For more information, see **Rough Science** episode 7: "Mediterranean Mystery"

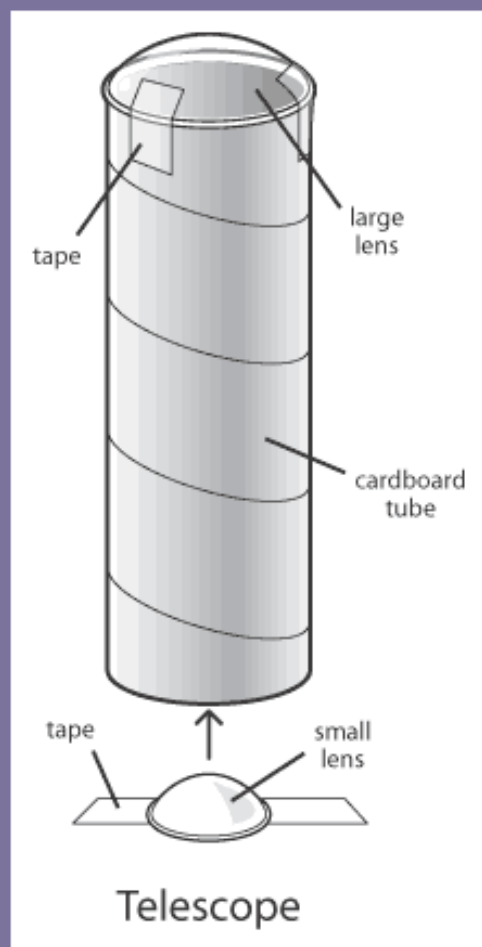





Major funding for Rough Science was provided by the [National Science Foundation](#). Corporate funding was provided by [DuPont](#).

Copyright © 2002 [The Open University](#) and [WETA](#).



## DISCOVER MORE

### Island General Store

Explore the Challenges

Solve the Web Challenge

Meet the Rough Scientists

About the TV Series

Discover More

Feedback

Site Map

Every tropical island needs a general store. This one is stocked with lots of useful items to help you and your customers have fun in the sun and enjoy yourselves after dark. Everything on the shelves is a rough science product.

#### The Challenges!

- To set the mood for meals and have light when there is no electricity, [make your own candles](#).
- To keep island visitors' teeth white and their breath fresh, [concoct homemade toothpaste](#).
- In case things come unstuck, [make rough science glue](#).
- To keep insect pests at bay, [make some insect repellent](#).

#### Make Candles

If you didn't build a flashlight in the Island Power Plant scenario, you'll still be able to function in the dark if you make some candles — for yourself and the general store customers.

#### You'll need:

- paraffin wax or beeswax
- colored crayons or dye
- powdered stearin
- wick
- wide, shallow pan
- two tall cans
- thermometer
- paper towel
- waxed paper
- pencil
- metal washer
- newspaper
- essential oil or perfume
- water

#### What you do:

Spread the newspaper over your work area. Heat water in the pan. Cut the wax into small chunks and add them to one of the tall cans. Set the can in the warm-water pan. Heat slowly, adding more chunks as the wax melts. When the wax has melted, stir in about 3 tablespoons of stearin for each pound of wax. For color, melt in the wax crayons or add dye. Use the thermometer to maintain the temperature of the molten wax between 150 and 180°F. Prepare the wick by cutting it into lengths 5 inches longer than the candle you want to make. Attach a metal washer to one end of the wick to weight it, and tie the other end to a pencil. Dip the wick into the molten wax, lift it up, and let the wax drip along the

wick. Dip the coated wick into the second tall can, filled with cool water. Lift the wick out, and use some paper towels to remove excess water. Place your candle on waxed paper for 30 seconds and then repeat the dipping process. Dip each candle 40 to 50 times until your candle is about 1 inch. As the size of the candle increases, you may need to straighten it by rolling it on waxed paper. When the candle is about 1 inch thick, add a tablespoon of stearin to the wax for one final dip. The added stearin will make the final wax coating of your candle dripleless. If you want to make scented candles, add a few drops of essential oil or perfume.

### What's going on?

The Romans used beeswax to make candles, but modern candles are made from a mixture of hard paraffin and stearin (added to increase the melting point and to prolong burning time). Stearin is a substance that changes the melting point of the wax. This allows the candle to harden faster. Stearin also makes candles firmer, dripleless, and brighter burning. It is harder than tallow. Wicks must be naturally absorbent to absorb liquid wax and move it upward while the candle is burning. The heat of the flame vaporizes the wax, and it is the wax vapor that burns. The wick does not burn because the vaporizing wax cools the exposed wick and protects it.

For other candle-making activities, see:

- <http://www.howstuffworks.com/question267.htm>
- <http://www.hollyhobby.com>
- <http://www.make-stuff.com>

For more information, see **Rough Science** episode 10: "Sustenance and Sayonara"

---

## Concoct Homemade Toothpaste

Fail to pack for your island vacation? Don't panic. Toothpaste doesn't have to come in a tube. You can make it from a few simple ingredients if you know the basic principles.

### You'll need:

- baking soda
- water
- calcium carbonate
- peppermint oil, mint, or lemon juice
- glycerin (optional)
- teaspoon
- a bowl

### What you do:

In the bowl, add 3 parts of baking soda to 1 part calcium carbonate. Add 2 teaspoons of glycerin and 5 to 10 drops of peppermint oil. Test for taste. If you like your toothpaste to tingle, add a bit more oil. Mix all of the ingredients thoroughly and add enough water to give a smooth, toothpaste consistency. You could use other flavorings, such as mint or lemon juice.

### What's going on?

Baking soda causes dirt and grease to dissolve in water. This cleansing action combines with the abrasive calcium carbonate (chalk) to produce an effective cleaning agent. The glycerin thickens the mixture to give it a paste consistency. The peppermint oil is for flavor.

For more information, see **Rough Science** episode 10: "Sustenance and Sayonara"

---

## Make Glue

Even island dwellers must make simple repairs. You never know when one of your customers might break something. Making this glue is so easy, you'll never run out.

**You'll need:**

- 1/2 cup warm milk
- 1/4 teaspoon baking soda
- 2 tablespoons vinegar
- water
- saucepan
- cup
- cheesecloth or coffee filter

**What you do:**

Slowly heat the milk until it is hot. Remove it from the heat and add 4 teaspoons of vinegar for every cup of milk. Place the curds in cheesecloth and then squeeze out the water. Rinse the curds with cool water. Squeeze out all the water and put the curds in a cup. Add a pinch of baking soda and mix with a little water to make the glue smooth.

**What's going on?**

When vinegar is added to milk, the acetic acid in the vinegar causes thick lumps (curds) of casein to develop and coagulate from the proteins in the milk. The acid separates the milk into curds and whey. The acid causes constituents of the proteins (amino acids) to react with each other, resulting in adhesion. Also the fibers in paper or other objects attract the casein that makes them stick together.

*Activity adapted from Lawrence Hall of Science. Secret Formulas. Regents of the University of California, 1996. See also <http://www.howstuffworks.com>.*

For more information, see **Rough Science** episode 10: "Sustenance and Sayonara"

---

## **Make Insect Repellent**

Insects are everywhere in the tropics and some carry diseases. You need to stock an effective insect repellent. This one really works. Watch it fly off the shelves!

**You'll need:**

- 1/4 cup denatured alcohol (available from [scientific supply companies](#))
- 1 1/2 teaspoons camphor (available from [scientific supply companies](#))
- 1 1/2 teaspoons calcium chloride (available from [scientific supply companies](#))
- bowl
- spoon

**What you do:**

Mix all the ingredients together in the bowl. Stir thoroughly until everything has dissolved. Before you go outside, apply the repellent to your skin but avoid getting any lotion near your eyes. Be sure to discontinue use at the first sign of an allergic reaction.

**What's going on?**

Camphor is a powerful natural repellent. It is an extract from the camphor laurel tree. Insects don't like the smells of the volatile oils (vapors) in the camphor.

For more information, see **Rough Science** episode 7: "Mediterranean Mystery"

---

**Suggestion for other activity:**

- Make your own filtered water and bottle it for sale. See the [Water Quality Control Center](#) scenario for directions on how to make a water filter.



[Discover More main page](#)

Major funding for Rough Science was provided by the [National Science Foundation](#). Corporate funding was provided by [DuPont](#).

Copyright © 2002 [The Open University](#) and [WETA](#).



## DISCOVER MORE

### Island Restaurant

Explore the Challenges

Solve the Web Challenge

Meet the Rough Scientists

About the TV Series

Discover More

Feedback

Site Map

If you're on a tropical island, it's great to know there is a restaurant where the food is fresh and the mood is mellow. After you're through with your rough science, don't forget to make a reservation!

#### The Challenges!

- To cook meals for your guests, [make a solar oven](#).
- To grow herbs and spices, [build a terrarium](#).
- To provide warm water, [build a solar water heater](#).

---

#### Make a Solar Oven

Nothing beats home cooking! It's your restaurant and you're the chef. Get creative with the menu. In fact, get creative with the oven. Make your own solar oven to prepare exquisite meals for your guests.

#### You'll need:

- a box with a lid, e.g. a pizza box
- black construction paper
- aluminum foil
- heavy plastic laminate
- glue
- transparent tape
- scissors
- ruler
- magic marker
- straw

**What you do:**

Draw a square on the lid of the box and cut along three sides of it. Fold back along the uncut side to form a flap that opens and shuts. Line the inside of the flap with aluminum foil, smoothed over and glued into place. Cut a piece of plastic to fit very tightly over the hole you created in the lid of the box by forming the flap. Use enough plastic to overlap the underside of the flap. Seal the plastic by taping it to the underside of the flap. (The plastic has to be tightly sealed to make sure that no air can escape from the oven.) Line the bottom of the box with foil, and glue it into place. Again, take care to smooth out all wrinkles. Cut out a piece of black construction paper to fit on the bottom and tape it in place. Close the lid (including the plastic window) and prop the flap open, facing the sun. Move the box around to get the maximum amount of sun into your oven. Try cooking something like s'mores. Compare the solar oven with the [solar water heater](#).

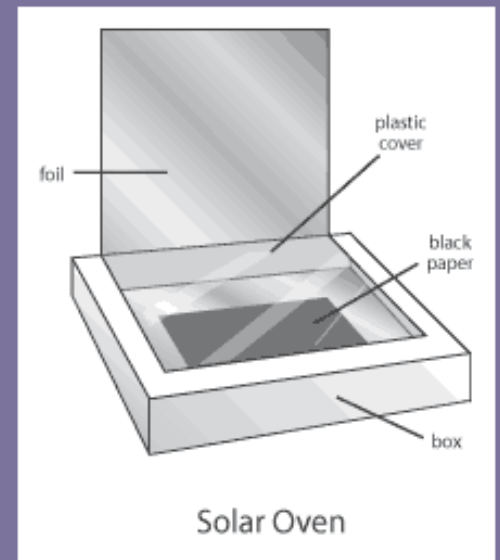
**What's going on?**

Energy, radiating from the sun, reflects off the foil. This heat energy is then stored in the oven.

For more information on solar-powered technology, see <http://www.solarnow.org/pizzabx.htm>.

For more information, see **Rough Science** episode 9: "Power Supplies"

**Make an Herb Terrarium**

Spice up your food and garnish dishes with herbs and spices grown in an herb terrarium (herbarium). Your restaurant will become an instant hit once customers realize that their palates will be pampered with subtle flavors. Building a terrarium is much easier than tending a garden, and it's low maintenance.

**You'll need:**

- a glass or plastic container, such as a candy jar or pickle jar, with a wide mouth and tight-fitting lid
- potting soil
- potted herbs
- colored stones
- shells
- water
- soap
- paper towel

**What you do:**

Do some research to select herbs that need similar conditions (soil, light, water) for growth. Take care to choose plants that will not outgrow the container. After cleaning, rinsing, and drying the container thoroughly, fill it  $\frac{1}{4}$  full with potting soil. Place the plants in the soil at a depth similar to that in their pots and press the soil down around them. Squeeze water from wet paper towels to moisten the soil around the plants, but do not overwater or you will kill them. (If you need to, you can add more water at a later date.) Decorate your terrarium with colored stones and shells. Close the lid tightly and place the terrarium where the plants will receive the light they need. You have created a self-sustaining ecosystem.

**What's going on?**

The lid traps air inside the terrarium. Plants use carbon dioxide and sunlight during the day to produce food and oxygen through photosynthesis. At night, they use the oxygen to create more carbon dioxide. The water trapped inside the terrarium is absorbed through the roots of the plants. It moves up through the stems and evaporates through the leaves. Like rain, the water will condense on the top of the terrarium and drip back down to the bottom. The oxygen, carbon dioxide, and water are therefore constantly being recycled by the plants.

For more information, see **Rough Science** episode 10: "Sustenance and Sayonara"

---

### Make a Solar Water Heater

Wash the sand off after a dip in the ocean with a relaxing warm shower hooked up to a solar water heater. All it takes is a few simple objects and plenty of sunshine!

#### You'll need:

- water jug
- large fish tank with a lid
- aluminum foil
- transparent tape
- cardboard, with an area greater than the base of the fish tank
- thermometer
- black paint
- paintbrush
- water

#### What you do:

Line the sides of the tank with aluminum foil, inside and out, and tape the foil firmly in place. Paint the bottom of the inside of the tank black. Place the cardboard in a spot that is in the sun all day. Place the tank squarely on the cardboard. Once the paint is completely dry, fill the tank with water. Put the lid on the tank. Use the thermometer to test the temperature of the water every half hour. If it gets too hot for a comfortable shower, remove the lid until the water equilibrates with the outside temperature.

#### What's going on?

Sunlight (infrared energy) passes through the glass and is absorbed by the water. Water has a high heat capacity (able to absorb and hold heat). A black surface absorbs some of the light (sunlight). If trapped, as it is in this case by the insulation (the foil), the heat (energy) accumulates and is reflected into the water so it gets warmer. The heat energy cannot escape as easily back through the glass so the water stays warm.

For more information, see **Rough Science** episode 9: "Power Supplies"

---

#### Suggestions for other activities:

- To make the ice cream taste better, add flavors or fruit.
- So patrons can be notified when their table is ready, make a buzzer for the maitre d' of the hotel. (See the [Island Power Plant](#) scenario.)
- Make butter, popcorn, and peanut butter, and soda.



[Discover More main page](#)



Major funding for Rough Science was provided by the [National Science Foundation](#). Corporate funding was provided by [DuPont](#).

Copyright © 2002 [The Open University](#) and [WETA](#).



## DISCOVER MORE

### Tropical Island Day Spa

Explore the Challenges

Solve the Web Challenge

Meet the Rough Scientists

About the TV Series

Discover More

Feedback

Site Map

Hot and sweaty from the tropical sun? What better way to recover than a luxurious day in a spa? Before you slather on that facemask and kick back in the sauna, you're going to have to figure out how to create the essentials for a day of pampering yourself! Discover the rough science behind what happens in a day spa.

#### The Challenges!

- To remove some of those layers of grime, [make scented and textured soap](#).
- To clean those pores and keep your skin hydrated and beautiful in the sun, [create a facial mask](#).
- To protect your lips from the sun, [make a lip balm](#).
- Leave that astringent cucumber mask on too long and you'll look like a prune! On an island you won't have a watch or clock so [construct a sundial](#).
- To discover just how bad the humidity really is, [build your own humidity indicator or hygrometer](#).

#### Add Scent and Texture to Your Soap

Soaps are made by boiling oils and fats with an alkali. Because this takes a long time and can be dangerous, we're going to use shredded olive oil soap as our base and add oils and flowers for scent and texture. For safety, ask the soap makers to tie back long hair and roll up their sleeves. Supervise young participants. To dry the soap quicker, place it in the sun or in a low oven for 15 minutes.

#### You'll need:

- 2 saucepans, 1 large, 1 small
- 1-lb. bar of olive oil soap
- grater
- plastic or glass droppers
- a selection of herbal tea bags (chamomile, green tea, fruit flavors)
- teapot or pitcher
- essential oils such as lavender, geranium, vanilla, sweet almond oil (You can buy herbal teabags and essential oils in health food stores.)
- dried flowers
- oatmeal
- tiny squares of candied fruit
- a blunt object such as a butter knife
- a cookie tray

#### What you do:

Shred a bar of soap using the grater. Place the large pan on a burner and fill the bottom with enough

water to cover the bottom of the small pan that you place inside the large pan. Take care to make sure that the inside of the small pan stays completely dry, and that there's always water in the large pan. Place the grated soap in the small pan. Heat the large pan slowly on a medium flame till the soap melts. Add 1/4 of a cup of strong tea (that you have made) to the soap, mixing it in thoroughly. Spoon the soap mixture onto a cookie tray in six equal measures. Knead, or mill, each soap mixture with a knife. When the soap firms up, add your choice of essential oils using the droppers. Continue to knead until the soap is hard enough to pick up. Form it into a shape, then roll your bar of soap in dried flowers, oatmeal, or candied fruit. Allow the soap to dry completely before you use it.

#### **What's going on?**

Soap molecules have both fatty acid and salt-like properties. The latter allow the soap to dissolve in water, while the fatty acid properties allow the soap to dissolve dirt and oils. The combination of the two sets of properties gives soap its ability to dissolve grease in water.

For more information, see **Rough Science** episode 10: "Sustenance and Sayonara"

---

### **Create a Facial Mask**

Whether your skin is oily or dry, it can benefit from a facial mask. Mixing eggs with mint and honey will make masks suited to oily skin; yogurt and cucumber will help rehydrate dry skin. Put slices of cucumber over your eyes while your mask is drying.

#### **You'll need:**

- eggs, cucumbers, instant nonfat dried milk, plain yogurt, chamomile flowers, fresh mint, and honey
- small bowls
- whisks
- graters

#### **What you do:**

In a small bowl, mix grated cucumber, yogurt, and dried milk with a whisk to create a moisturizing mask for dry skin. Mix egg, chamomile flowers, fresh mint, and honey with a whisk in another bowl to produce an astringent mask that will tighten pores in oily skin. Apply the mask that matches your complexion to your face for 15 minutes, and then rinse it off with warm water.

#### **What's going on?**

The yogurt mask increases the flow of sebum (oil produced by glands in your skin) by causing your skin tissue to expand. The astringent (an agent that contracts tissue to reduce secretions) mask made from mint shrinks skin tissue and reduces the sebum flow.

For more information, see **Rough Science** episode 10: "Sustenance and Sayonara"

---

### **Make Lip Balm**

Do your lips feel dry and burned from exposure to the tropical sun? What can you do to protect them? Let's make a scented lip balm using a mixture of beeswax and almond oil.

#### **You'll need:**

- 1/4 cup sweet almond oil
- 1/4 oz. beeswax
- metal spoons
- tropical fruit-flavored oils, such as mango, pineapple or coconut
- small jars for lip balm

- saucepan
- small metal container
- water

#### What you do:

Put a saucepan with a small amount of water on a low burner. Place the almond oil in a small metal container and place it in the water in the pan. When the oil warms up, add the beeswax to the container. Stir the mixture with a metal spoon until the beeswax is completely melted. Add drops of flavored oil and mix some more. Remove the mixture from the heat. Collect some in the spoon and put it in a cool place. When the spoonful hardens, test it with your finger. If your balm is too hard, add more oil. If it's too soft, add more beeswax. If the flavor is weak, add more drops of oil.

#### What's going on?

Lip balms and lip glosses contain oils and waxes that protect the lips and therefore act like a water repellent.

For more information, see **Rough Science** episode 10: "Sustenance and Sayonara"

---

### Construct a Sundial

You have to watch how long you wear that facial mask. So let's make a timepiece for the spa.

#### You'll need:

- [sundial template](#)
- a magnetic compass
- card stock
- elastic string with metal ends
- atlas

#### What you do:

Copy the [sundial template](#) onto card stock. Fold the tabs to an angle that corresponds to your latitude, as shown on an atlas. Then fold down both tabs to form the base of the sundial. Open your sundial to form a 90-degree angle and fold in the supporting tabs. To finish the dial, attach the elastic string through the holes at the top and bottom at the points where all the hour lines converge. This string is the gnomon (pronounced no-mun) and casts the shadow to indicate the time. To provide accurate time, the sundial (1) must be orientated with the gnomon pointing North/South; (2) must be located where a shadow will be cast by the gnomon most of the day. (Note: one can move the dial from window to window as the day progresses.) For greater accuracy, see the Equation of Time chart on the upper face of the sundial. A magnetic compass may be used to determine the North/South line. Because of the difference between magnetic North and true North, the sundial reading could be off by an hour or more. The variation will depend on the local difference between magnetic and true North.

#### What's going on?

Your location on Earth in relation to the sun determines the time where you are. Because the Earth rotates as it travels round the sun, the date is also very important. Compare 5 o'clock in the afternoon in July with the same time in December. Your watch or clock measures standard time. Your sundial records solar time, which is not the same. According to solar time, noon is when the sun is directly overhead. Even though noon in Boston, New York and Miami happens at the same moment in standard time, there would be noticeable differences if you measured noon at all three locations in solar time.

*Activity adapted from Sun Sculpture & Sundial-Making Kit. New York Hall of Science, 2002. For information on making other sundials, see [Liftoff to Space Exploration: A Space Sciences Project](#).*

For more information, see **Rough Science** episode 7: "Mediterranean Mystery"

---

## Make a Humidity Indicator

Is the tropical humidity giving you another "bad hair day"? Let's figure out how to determine how high the humidity is.

### You'll need:

- aluminum foil
- newspaper
- tape
- pencil
- scissors
- empty spool

### What you do:

Cut a strip of aluminum foil (10" x 4") and a strip of newspaper (10" x 10"). Tape the edges of the aluminum strip to the middle of the newspaper. Tape one end of the newspaper-aluminum strip to the top of the pencil and carefully and tightly wind the rest of it around the pencil. Place the pencil in the spool. If the weather is humid, the strip will unwind in the moist air. If the air becomes dry again, the strip will wind closed.

### What's going on?

The paper expands when it absorbs moisture. The aluminum foil, a metal, doesn't absorb moisture. The tension between the two causes the strip to unwind and wind according to the amount of moisture in the air.

For more information, see **Rough Science** episode 2: "Bugs and Barometers"

---

### Suggestions for other activities:

- To make body paint, extract dye from plants, fruits, vegetables and flowers.
- To make hair gel and aromatherapy shampoos, use plants.
- To make henna tattoos, use henna (a natural dye that dates back to the ancient Egyptians) to produce a deep red/orange/brown color.
- To make a perfume, blend natural oils.



[Discover More main page](#)

Major funding for Rough Science was provided by the [National Science Foundation](#). Corporate funding was provided by [DuPont](#).

Copyright © 2002 [The Open University](#) and [WETA](#).



## DISCOVER MORE

### Tropical Island Party

Explore the Challenges

Solve the Web Challenge

Meet the Rough Scientists

About the TV Series

Discover More

Feedback

Site Map

On vacation let your hair down. What better place for a party than a tropical island paradise? But who would have thought that rough science could help make you the perfect host?

#### The Challenges!

- For original invitations, [make your own paper](#).
- To wake up the party poopers, [create botanical noisemakers](#).
- For refreshments, offer homemade [ice cream](#) and [soda](#).

#### Make Paper

You need to let people know when and where to come to the party. But first you'll need some paper to write your invitations.

#### You'll need:

- plain office paper, newspaper, magazines, egg cartons, toilet paper, paper bags, old cards, nonwaxed boxes pre-soaked in warm water, tissue paper, napkins, or construction paper (any of these types of paper or a mixture)
- sponge
- screening from a window or door
- an old picture frame or other wooden frame
- plastic tub large enough to accommodate the wooden frame
- blender or food processor
- white felt or flannel fabric
- staples or tacks
- liquid starch
- 2 cookie sheets

#### What you do:

Rip the paper into small pieces and place it in a blender until half full. Fill the blender up with warm water. Blend slowly until there is no trace of paper and the pulp is smooth. Staple the screen to the frame as tightly as possible to make a deckle. Fill half the basin with water and add 3 blenders-full of pulp. (For thicker paper, add more pulp.) Stir well and add 2 teaspoons of liquid starch. Submerge the deckle in the pulp and gently shake it until you have an even covering on top of the screen. Lift the deckle above the water level and let it drain off. (If the new paper on top of the screen is too thick, take some pulp out of the tub. If the paper is thin, add more pulp and re-stir.) When the deckle stops dripping completely, carefully place one edge along an edge of fabric and gently ease the paper out of the deckle on top of the fabric. Press out as much water as possible with the sponge. Make sure the paper has come apart completely from the deckle. Stack the fabric and paper pieces on a cookie sheet. Put a piece of fabric on top of the top sheet of paper and cover the pile with another cookie sheet. Press well to remove any remaining water. Gently separate the sheets of paper and hang them in the

sun, or lay them on sheets of newspaper, until they are dry.

### What's going on?

Paper is made from plant fibers — old rags, trees. By chopping up the paper, you are recycling the fibers in the old paper to make new paper. The liquid starch helps to prevent inks from soaking into the paper fibers.

For more information on making paper, see <http://www.pioneerthinking.com>.

For more information, see **Rough Science** episode 1: "Mapping it Out"

---

### Make Botanical Noisemakers

You don't want anyone to miss the fun! Let everyone know where the party is with some rattles, shakers, and other noisemakers.

#### You'll need:

- dried beans, peas, rice, nuts in shells, or other dry seeds
- 2 aluminum pie plates
- empty film canisters and lids
- empty plastic bottles and lids
- craft sticks
- tape
- scissors

#### What you do:

Place a handful of beans, peas, nuts, or seeds between two pie plates and then tape the plates together around the edges. Use a pair of scissors to make small slits in the bottom of the canisters, and insert craft sticks through the holes. Put different amounts of rice inside the film canisters and put on the lids. Put other plant materials inside the plastic bottles. Shake them to different rhythms.

### What's going on?

Sounds come from vibrations. Shaking the noisemakers causes the beans, rice, or other plant materials to hit against the pie plates and vibrate, thus creating sound.

*Activity adapted from Jill Frankel Hauser and Loreta Trezzo Brare. Kid's Crazy Concoctions. Williamson Publishing, 1998.*

For more information, see **Rough Science** episode 6: "The Science of Celebration"

---

### Make Ice Cream

What's a tropical party without ice cream? Take the temperature down a degree or two by making your own chocolate ice cream.

#### You'll need:

- cream
- milk
- ice cubes
- dish towel
- cocoa powder
- tablespoon
- salt

- glass
- large bowl

**What you do:**

In the glass, mix one spoon of cocoa powder, two spoonfuls of milk, and one spoonful of cream. Put some ice in the bowl and cover it with lots of salt. Put the glass on top of the ice and pack ice around the glass. Cover all the ice with salt. Place the dish towel over the bowl and leave the ice cream mixture to set for an hour. Voilá — delicious chocolate ice cream!

**What's going on?**

The salt lowers the freezing temperature of the ice. This actually makes the ice colder. The ice absorbs heat from the ice cream mixture. The ice cream gets colder and colder until it eventually freezes.

How about using flavors other than chocolate? Lemon, vanilla, orange, or raspberry?

For more information, see **Rough Science** episode 10: "Sustenance and Sayonara"

---

### Make Lemon or Orange Soda

Throwing a party is thirsty work! You'll need something to quench your thirst and give you the energy to keep dancing all night. Make a refreshing soda from a few simple ingredients.

**You'll need:**

- a lemon or orange
- a glass
- water
- sugar
- 1 teaspoon baking soda

**What you do:**

Squeeze a lemon or orange and put the juice in the glass. Add an equal volume of water and some sugar till your drink tastes sweet enough. Stir in the baking soda and stand back as your drink fizzes.

**What's going on?**

Baking soda is a chemical compound called a carbonate. Lemon and orange juices contain acids. When a carbonate and an acid are mixed, they produce a salt. Baking soda is a buffer. In the presence of an acid, carbon dioxide gas is released, producing the bubbles in your drink. A similar reaction, producing carbon dioxide, is used in certain fire extinguishers.

For more information, see **Rough Science** episode 10: "Sustenance and Sayonara"

---

**Suggestions for other activities:**

- To make sounds like a horn, recorder, drum, and whistle, make musical instruments from natural materials (willow sticks, vines, tree branches, shells, blades of grass).
- To have neat jewelry to wear, make bracelets and rings from plants.



[Discover More main page](#)



Major funding for Rough Science was provided by the [National Science Foundation](#). Corporate funding was provided by [DuPont](#).

Copyright © 2002 [The Open University](#) and [WETA](#).



## EXPLORE THE CHALLENGES

- [Explore the Challenges](#)
- [Solve the Web Challenge](#)
- [Meet the Rough Scientists](#)
- [About the TV Series](#)
- [Discover More](#)
- [Feedback](#)
- [Site Map](#)



[Sound Recording](#) | [Scale Map](#) | [Paper and Ink](#) | [Weather](#)  
[Antibacterial Cream](#) | [Microscope](#) | [Transmitter and Receiver](#) | [Clocks](#) | [Kite](#)  
[Ice](#) | [Thermometer](#) | [Sunblock](#) | [Recharge a Battery](#) | [Solar Distillation](#)  
[Underwater Flashlight](#) | [Fireworks](#) | [Musical Instruments](#) | [Find Latitude and Longitude](#)  
[Saucepan Radio](#) | [Camera](#) | [Generate Electricity](#) | [Soap](#)

Major funding for Rough Science was provided by the [National Science Foundation](#). Corporate funding was provided by [DuPont](#).

Copyright © 2002 [The Open University](#) and [WETA](#).



# SOLVE THE WEB CHALLENGE

Explore the Challenges

Solve the Web Challenge

Meet the Rough Scientists

About the TV Series

Discover More

Feedback

Site Map

Mike Bullivant needs your help! He's in danger on the other side of Carriacou. Can you use your knowledge of science to rescue him?

This adventure requires the [Flash player](#).



Once you have Flash, [start the Web Challenge](#).



Major funding for Rough Science was provided by the [National Science Foundation](#). Corporate funding was provided by [DuPont](#).

Copyright © 2002 [The Open University](#) and [WETA](#).



# SITE MAP

Explore the Challenges

Solve the Web Challenge

Meet the Rough Scientists

About the TV Series

Discover More

Feedback

Site Map

## The Challenges

[Explore the Challenges](#)

[Sound Recording](#)

[Scale Map](#)

[Paper and Pen](#)

[Weather](#)

[Anti-bacterial cream](#)

[Microscope](#)

[Transmitter](#)

[Clocks](#)

[Kite](#)

[Ice](#)

[Thermometer](#)

[Sunscreen](#)

[Recharge Battery](#)

[Solar Distillation](#)

[Underwater Torch](#)

[Fireworks](#)

[Musical Instruments](#)

[Latitude and](#)

[Longitude](#)

[Radio](#)

[Camera](#)

[Generate Electricity](#)

[Make Soap](#)

## Web Challenge

[Solve the Web Challenge](#)

## The Scientists

[Meet the Rough Scientists](#)

[Mike Bullivant](#)

[Carriacou Diary](#)

[Capraia Diary](#)

[Carriacou Interview](#)

[Capraia Interview](#)

[Vanessa Griffiths](#)

[Capraia Diary](#)

[Capraia Interview](#)

[Jonathan Hare](#)

[Carriacou Diary](#)

[Capraia Diary](#)

[Carriacou Interview](#)

[Capraia Interview](#)

[Mike Leahy](#)

[Carriacou Diary](#)

[Capraia Diary](#)

[Carriacou Interview](#)

[Capraia Interview](#)

[Anna Lewington](#)

[Capraia Interview](#)

[Ellen McCallie](#)

[Carriacou Diary](#)

[Carriacou Interview](#)

[Kathy Sykes](#)

[Carriacou Diary](#)

[Carriacou Interview](#)

## TV Series

[About the TV Series](#)

[Host Kate Humble](#)

[Episode Descriptions](#)

[Local Airdates](#)

[Production Credits](#)

[About Open](#)

[University](#)

[About NSF](#)

[About DuPont](#)

[Discover More](#)

[Discover More](#)

[A Brief History of Science](#)

[What is Science](#)

[All About?](#)

[The Art of Science](#)

[Create Your Own](#)

[Rough Science](#)

[Adventure](#)

[Rough Science](#)

[Museum](#)

[Adventures](#)

[Rough Science](#)

[Metric Converter](#)

[Books](#)

[Web Sites](#)

[Scientific Supply](#)

[Companies](#)

[Feedback](#)

[E-Mail](#)

[Message Boards](#)

Major funding for Rough Science was provided by the [National Science Foundation](#). Corporate funding was provided by [DuPont](#).

Copyright © 2002 [The Open University](#) and [WETA](#).



## EXPLORE THE CHALLENGES

### The Challenge: Make Paper and Ink

Page: 1 [2](#) [3](#) [4](#) [5](#) [6](#) [7](#)

Explore the Challenges

Solve the Web Challenge

Meet the Rough Scientists

About the TV Series

Discover More

Feedback

Site Map

Many different plants and materials have been used to make paper and ink over the centuries. What would our scientists use from the island to make theirs and would they be able to produce a clean sheet and colored inks in just three days?

#### What is paper and how is it made?

Paper is made from [cellulose](#). All plant matter is composed in part from cellulose fiber but the amount [varies between plants](#). The reason why plant material is so suitable for making paper lies in the molecular structures of cellulose and water. Water molecules are made up of one oxygen atom and two hydrogen atoms. The hydrogen atom on one molecule can chain onto the oxygen atom of another molecule causing an effect called 'surface tension'. This chaining process is the key to making paper.



Water Molecule

[How chaining works](#)



Major funding for Rough Science was provided by the [National Science Foundation](#). Corporate funding was provided by [DuPont](#).

Copyright © 2002 [The Open University](#) and [WETA](#).



## EXPLORE THE CHALLENGES

### The Challenge: Make an Antibacterial Cream

Page: [1](#) [2](#) [3](#) [4](#) [5](#) [6](#) [7](#) [8](#) [9](#) [10](#) [11](#) [12](#)

Explore the Challenges

Solve the Web Challenge

Meet the Rough Scientists

About the TV Series

Discover More

Feedback

Site Map

#### Time to get thinking.

An [antiseptic](#) is a substance that destroys, or stops the growth of, germs on living tissue. They must be strong enough to fight germs but mild enough not to irritate sensitive tissues. Antiseptics should not be confused with [disinfectants](#) and [antibiotics](#).

An antiseptic cream that causes the death of bacteria is called a bactericidal cream or antibacterial cream and is useful for preventing cuts, scratches and insect bites from becoming infected.

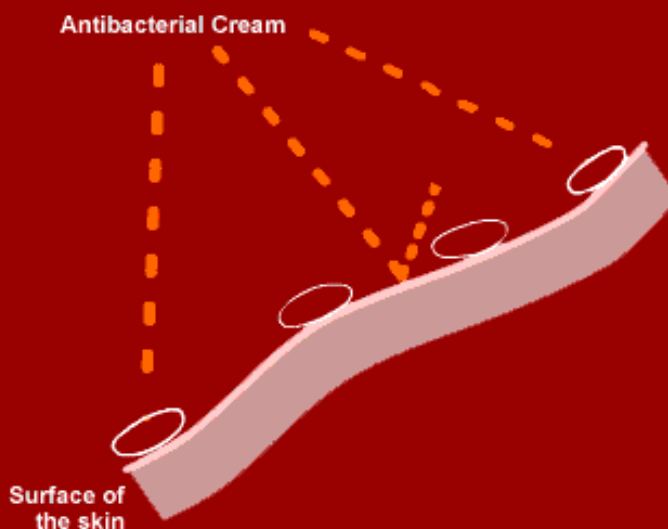

[What are bacteria?](#)



Major funding for Rough Science was provided by the [National Science Foundation](#). Corporate funding was provided by [DuPont](#).

Copyright © 2002 [The Open University](#) and [WETA](#).



## EXPLORE THE CHALLENGES

### The Challenge: Make a Microscope

Page: 1 [2](#) [3](#) [4](#) [5](#) [6](#)

[Explore the Challenges](#)

[Solve the Web Challenge](#)

[Meet the Rough Scientists](#)

[About the TV Series](#)

[Discover More](#)

[Feedback](#)

[Site Map](#)

Would it be possible to make a microscope on the island using just a basic array of wire, glassware, kitchen utensils and a car battery but not a clean glass lens in sight?

#### How does a microscope work?

Essentially, a microscope is just a lens. You can see the principle quite easily by looking through a tiny drop of water. Try balancing a water droplet on a 2mm (.078 in.) hole made in cardboard and looking through it. You'll have to get your eye very close — and the object you're looking at very close too — but it magnifies surprisingly well.

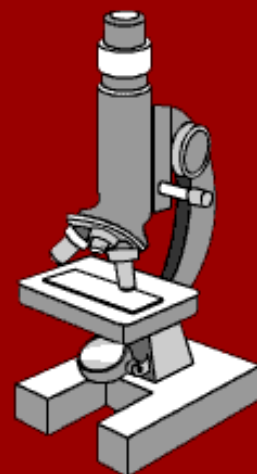

[Why use glass?](#)



Major funding for Rough Science was provided by the [National Science Foundation](#). Corporate funding was provided by [DuPont](#).

Copyright © 2002 [The Open University](#) and [WETA](#).





## EXPLORE THE CHALLENGES

### The Challenge: Make a Transmitter and Receiver

Page: [1](#) [2](#) [3](#) [4](#) [5](#) [6](#) [7](#) [8](#) [9](#) [10](#)

Explore the Challenges

Solve the Web Challenge

Meet the Rough Scientists

About the TV Series

Discover More

Feedback

Site Map

**WARNING: Most unlicensed radio broadcasts are illegal in the U.S. The following is for informational purposes only.**

With just a basic tool kit, some copper wire, a piece of coke, a car battery, a bottle of rum, and some old kitchen pots and pans would we be able to transmit a signal across the island and successfully decipher the message?

**What sort of signal are we going to transmit?**

Since the beginning of time, people have been trying to communicate over distances greater than the human voice can travel. More rudimentary attempts included the use of smoke, fires and waving flags. Mirrors were also used to flash the image of the sun to distant objects.

After the discovery of electricity, a revolution in communication took place. Wires were stretched from one point to another and an electric current passed through them, controlled by a switch called a telegraph key. A light or buzzer could be turned on and off over great distances and using a simple code, such as the Morse system, people were able to communicate almost instantly over distances that had previously required days or weeks by horse or train.



In 1901, Marconi sent a signal across the Atlantic using the recently discovered radio waves. It paved the way for today's complex wireless communications systems such as satellites and mobile phones.

[What is a transmitter?](#)



Major funding for Rough Science was provided by the [National Science Foundation](#). Corporate funding was provided by [DuPont](#).

Copyright © 2002 [The Open University](#) and [WETA](#).



## EXPLORE THE CHALLENGES

### The Challenge: Make a kite from natural products

Page: 1 [2](#) [3](#) [4](#) [5](#) [6](#) [7](#) [8](#) [9](#)

Explore the Challenges

Solve the Web Challenge

Meet the Rough Scientists

About the TV Series

Discover More

Feedback

Site Map

#### How does a kite fly?

Most people associate kite flying with a strong wind to get the kite into the air but most kites are designed for light breezy conditions. Although you do not need to know anything about aerodynamics to fly a kite, it helps you control your kite if you understand basic wind flow and lift. There are two main principles involved in the aerodynamics of a kite:

The first is [Newton's Third Law of Motion](#) and the second is [Bernoulli's Theorem](#).



[Newton's Third Law](#)



Major funding for Rough Science was provided by the [National Science Foundation](#). Corporate funding was provided by [DuPont](#).

Copyright © 2002 [The Open University](#) and [WETA](#).



## EXPLORE THE CHALLENGES

### The Challenge: Measure Latitude and Longitude

Page: [1](#) [2](#) [3](#) [4](#) [5](#) [6](#) [7](#) [8](#) [9](#) [10](#)

Explore the Challenges

Solve the Web Challenge

Meet the Rough Scientists

About the TV Series

Discover More

Feedback

Site Map

To pinpoint your position on a map of the world you need to work out your co-ordinates, known as latitude and longitude. Latitude is your position north or south of the Equator. Lines, or parallels, are drawn around the Earth at intervals. The North Pole is assigned the latitude  $90^\circ$  north and the South Pole latitude  $90^\circ$  south.

Lines of longitude, or meridians, are drawn a little differently. The line of longitude corresponding to  $0^\circ$ , which passes through Greenwich in London, is called the Prime (or Greenwich) Meridian. Longitude lines run along the Earth's surface in a north-south direction, and unlike latitude lines, they divide the globe into segments like those of an orange, rather than regular strips.

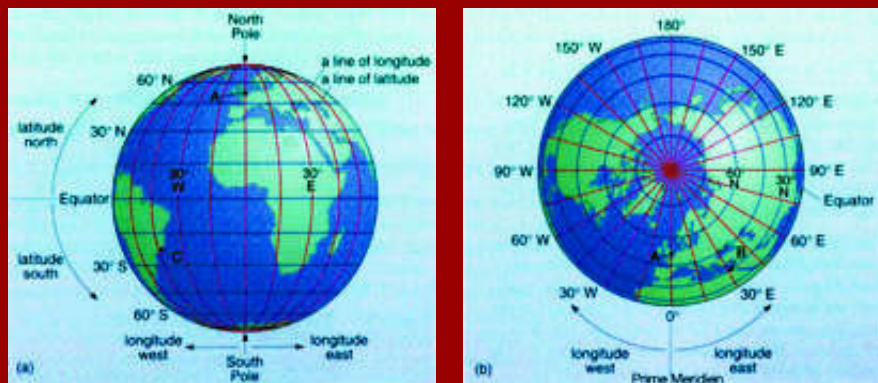

A geographical globe (a) viewed from above the Equator; (b) viewed from above the North Pole

[Measuring latitude](#)



Major funding for Rough Science was provided by the [National Science Foundation](#). Corporate funding was provided by [DuPont](#).

Copyright © 2002 [The Open University](#) and [WETA](#).



## EXPLORE THE CHALLENGES

The Challenge: Build accurate clocks, construct a timepiece that chimes and make a portable 'watch'

Page: 1 [2](#) [3](#) [4](#) [5](#) [6](#) [7](#) [8](#)

Explore the Challenges

Solve the Web Challenge

Meet the Rough Scientists

About the TV Series

Discover More

Feedback

Site Map

To tell the time in a Rough Science environment — where we only have access to a tool kit, rope, buckets, hoses and old scrap — it is probably easiest to use the sun, a local ingredient which was thankfully in plentiful supply. The one point that is relatively easy to determine by using a sundial is local noon. But how do we make the sundial tell the time accurately, how do we get a clock to chime, and with the rough components on the island, how will we ever make a wristwatch?

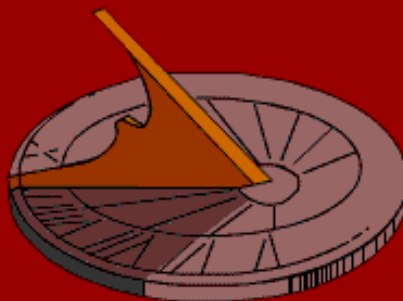

[How does a clock work?](#)



Major funding for Rough Science was provided by the [National Science Foundation](#). Corporate funding was provided by [DuPont](#).

Copyright © 2002 [The Open University](#) and [WETA](#).



## EXPLORE THE CHALLENGES

### The Challenge: Recharge a Battery

Page: 1 [2](#) [3](#) [4](#) [5](#) [6](#) [7](#) [8](#) [9](#) [10](#)

[Explore the Challenges](#)

[Solve the Web Challenge](#)

[Meet the Rough Scientists](#)

[About the TV Series](#)

[Discover More](#)

[Feedback](#)

[Site Map](#)

Batteries store electrical energy. Some, like conventional flashlight batteries, are used then thrown away. Others are rechargeable. On the island, we had a car battery which was used to power various pieces of Rough Science apparatus but over time the battery became discharged. We were given the challenge of recharging it.

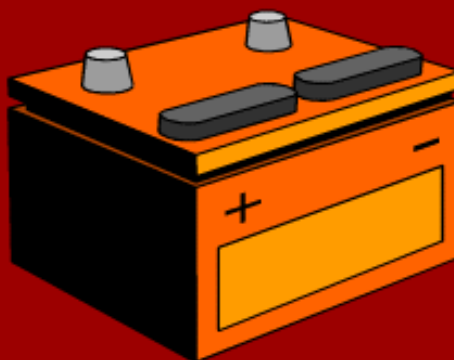

[How does a battery work?](#)



Major funding for Rough Science was provided by the [National Science Foundation](#). Corporate funding was provided by [DuPont](#).

Copyright © 2002 [The Open University](#) and [WETA](#).



## EXPLORE THE CHALLENGES

### The Challenge: Make an underwater flashlight

Page: 1 [2](#) [3](#) [4](#) [5](#) [6](#) [7](#) [8](#)

Explore the Challenges

Solve the Web Challenge

Meet the Rough Scientists

About the TV Series

Discover More

Feedback

Site Map

With access only to a basic tool kit, some reels of wire, pots and pans, rusting kitchen equipment and a car battery would we be able to make a light at all, let alone a flashlight that worked underwater?

#### How is light created?

Whether using fire, electricity or even a chemical reaction, you are essentially doing the same thing: giving atoms energy and getting them 'excited'. The energy absorbed by the atoms is taken up by the [electrons](#) that surround an atom's nucleus. The energy carries the electrons further away from the nucleus than normal and the atom is in an 'excited' state. When the electrons fall back to their ground state, closer to the nucleus, energy is radiated away again.

Electrons can give off different kinds of electromagnetic radiation when they fall back to their [ground](#) state but we're particularly interested in getting them to emit radiation within the visible spectrum.

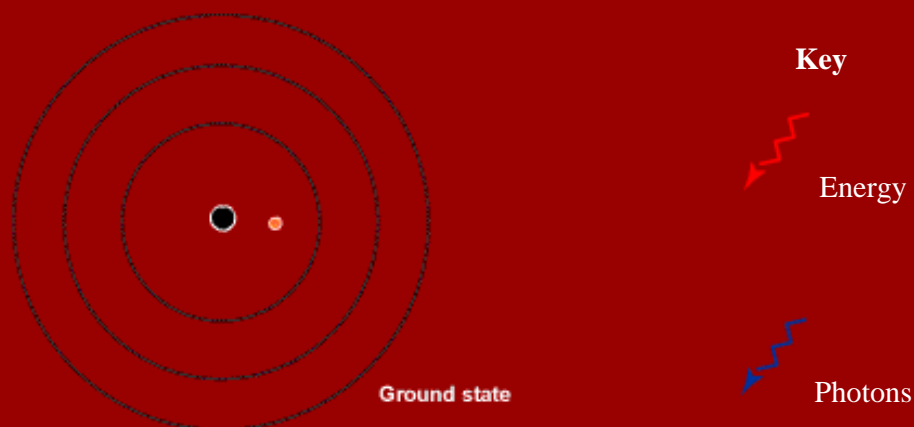

[Exciting the atoms](#)



Major funding for Rough Science was provided by the [National Science Foundation](#). Corporate funding was provided by [DuPont](#).

Copyright © 2002 [The Open University](#) and [WETA](#).



## EXPLORE THE CHALLENGES

### The Challenge: Make a radio from a saucepan

Page: 1 [2](#) [3](#) [4](#) [5](#) [6](#) [7](#) [8](#) [9](#)

Explore the Challenges

Solve the Web Challenge

Meet the Rough Scientists

About the TV Series

Discover More

Feedback

Site Map

Radio waves fill the space around us every second of the day. They emanate from local radio stations, mobile phones, short-wave radio transmitters around the world, and some even from satellites 36,000km (about 22,000 miles) out in space.

Radio is fundamentally about electricity and magnetism. Every time an electric current is turned on or off it creates electricity and magnetism in the form of radio waves. That's why you often hear a click on the radio when a nearby light switch is turned on or off. The radio waves radiate from the switch much like the ripples formed when a stone is dropped into a pond. Radio waves, like visible light, X-rays and microwaves, are all forms of electromagnetic radiation travelling at the speed of light — an incredible 300,000,000 meters per second (186,000 miles per second)!

A radio transmitter is simply a device that continuously produces radio waves. It uses an electric circuit that causes a current to oscillate. By varying the strength of this oscillation according to, say, the loudness of a piece of music, you can encode information about the music onto the radio waves. These encoded waves are then transmitted from an antenna and picked up by a receiver that decodes the signal so that you can hear the music again.

[How a radio works](#)



Major funding for Rough Science was provided by the [National Science Foundation](#). Corporate funding was provided by [DuPont](#).

Copyright © 2002 [The Open University](#) and [WETA](#).



## EXPLORE THE CHALLENGES

### The Challenge: Generate electricity

Page: [1](#) [2](#) [3](#) [4](#) [5](#) [6](#) [7](#)

Explore the Challenges

Solve the Web Challenge

Meet the Rough Scientists

About the TV Series

Discover More

Feedback

Site Map

A generator is simply a device that converts mechanical energy (itself derived from coal, oil, natural gas, wind, water, nuclear reactions or other sources) into electrical energy. Here, we describe how to use readily available materials to make a simple generator. Although it will only be powerful enough to light a small torch bulb, it works on the same basic principles as the power station generators that supply domestic electricity.

#### How a Generator Works

When an electric current flows through a wire, it generates a three-dimensional magnetic force field around the wire, similar to that surrounding a bar magnet. Magnets are also surrounded by a similar three-dimensional field. This can be "seen" in two dimensions if iron filings are sprinkled on a sheet of paper placed over the magnet. The filings align themselves along the lines of magnetic force surrounding the magnet.

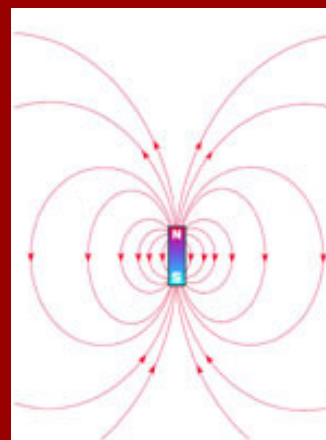

Two-dimensional representation of the magnetic field around a bar magnet. The arrows indicate the direction of the lines of magnetic force. The N (north) and S (south) indicate the poles of the magnet, where the lines of force are focused. The north pole of the magnet will repel the north pole of a compass or another bar magnet, while its south pole will attract the north pole of a compass or another bar magnet.

The simplest generator consists of just a coil of wire and a bar magnet. When you push the magnet through the middle of the coil, an electric current is produced in the wire. The current flows in one direction as the magnet is pushed in, and in the other direction as the magnet is removed. In other words, an alternating current is produced. If you hold the magnet absolutely still inside the coil, no current is generated at all. Another way of producing the current would be for the magnet to be rotated inside the coil, or for the coil to be rotated round the magnet.

This method of generating electricity, called induction, was discovered by Michael Faraday in 1831. He found that the stronger the magnets were, the more turns of wire in the coil, and the quicker the motion of the magnet or coil, the greater the voltage produced. Faraday also observed that it was more efficient if the coil was wound around a metal core, as this helped to concentrate the magnetic field.

[The Rough Science generators](#)





Major funding for Rough Science was provided by the [National Science Foundation](#). Corporate funding was provided by [DuPont](#).

Copyright © 2002 [The Open University](#) and [WETA](#).



## EXPLORE THE CHALLENGES

### The Challenge: Make Soap

Page: 1 [2](#) [3](#) [4](#) [5](#) [6](#)

Explore the Challenges

Solve the Web Challenge

Meet the Rough Scientists

About the TV Series

Discover More

Feedback

Site Map

In theory, you can make soap by treating almost any fat or oil with sodium hydroxide or potassium hydroxide (for a 'soft' soap). Some recipes use animal fats like tallow (from beef) or lard (from pork). Others use vegetable oils, like coconut or olive oil. Soapmaking (or saponification as the chemical reaction is called), like any chemical experiment, is sensitive to the purity of the reactants, the reaction conditions used and the care with which you carry it out.

[Making soap on Capraia](#)



Major funding for Rough Science was provided by the [National Science Foundation](#). Corporate funding was provided by [DuPont](#).

Copyright © 2002 [The Open University](#) and [WETA](#).