



Orienteering Home

**The Sport:**

- Orienteering History
- Orienteering

**Overview**

- Course Setup
- Officials
- Start/Finish Areas
- Course Safety
- Control Point

**Guidelines**

- Map Symbols
- Orienteering

**Techniques**

- Civilian Orienteering

**The Skills:**

- Maps
- Marginal Information and Symbols
- Grids
- Scale and Distance
- Direction
- Overlays
- Aerial Photographs
- Navigation

**Equipment and Methods**

- Elevation and Relief
- Terrain Association
- Navigation in

**Different Types of Terrain**

- Field Sketching
- Map Folding

**Techniques**

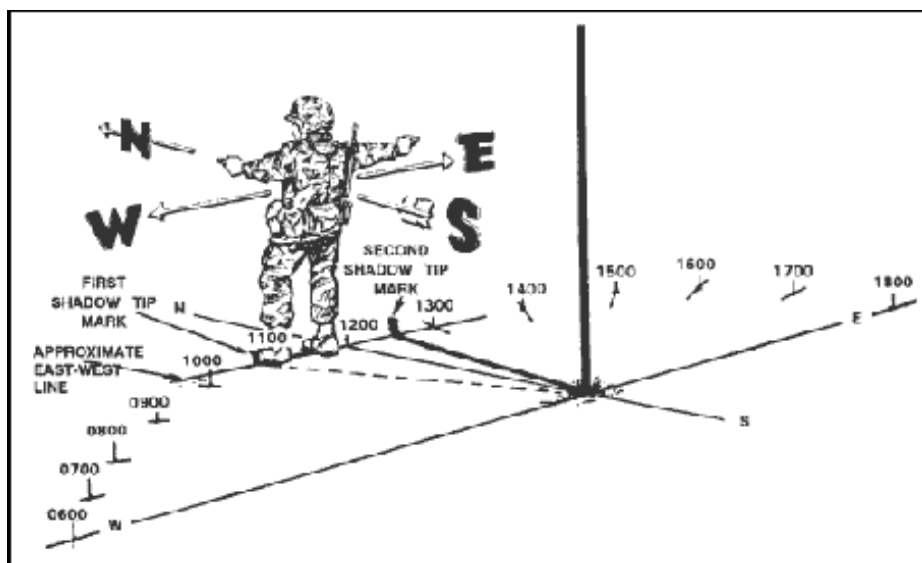
- Units of Measure and Conversion Factors

## Field-Expedient Methods

When a compass is not available, different techniques should be used to determine the four cardinal directions.

a. **Shadow-Tip Method.**

(1) This simple and accurate method of finding direction by the sun consists of four basic steps (Figure 9-7).



**Figure 9-7. Determining directions and time by shadow.**

**Step 1.** Place a stick or branch into the ground at a level spot where a distinctive shadow will be cast. Mark the shadow tip with a stone, twig, or other means. This first shadow mark is always the west direction.

**Step 2.** Wait 10 to 15 minutes until the shadow tip moves a few inches. Mark the new position of the shadow tip in the same way as the first.

**Step 3.** Draw a straight line through the two marks to obtain an approximate east-west line.

**Step 4.** Standing with the first mark (west) to your left, the other

directions are simple; north is to the front, east is to the right, and south is behind you.

(2) A line drawn perpendicular to the east-west line at any point is the approximate north-south line. If you are uncertain which direction is east and which is west, observe this simple rule--the first shadow-tip mark is always in the west direction, everywhere on earth.

(3) The shadow-tip method can also be used as a shadow clock to find the approximate time of day (Figure 9-7).

(a) To find the time of day, move the stick to the intersection of the east-west line and the north-south line, and set it vertically in the ground. The west part of the east-west line indicates 0600 hours, and the east part is 1800 hours, anywhere on earth, because the basic rule always applies.

(b) The north-south line now becomes the noon line. The shadow of the stick is an hour hand in the shadow clock, and with it you can estimate the time using the noon line and the 6 o'clock line as your guides. Depending on your location and the season, the shadow may move either clockwise or counterclockwise, but this does not alter your manner of reading the shadow clock.

(c) The shadow clock is not a timepiece in the ordinary sense. It makes every day 12 unequal hours long, and always reads 0600 hours at sunrise and 1800 hours at sunset. The shadow clock time is closest to conventional clock time at midday, but the spacing of the other hours compared to conventional time varies somewhat with the locality and the date. However, it does provide a satisfactory means of telling time in the absence of properly set watches.

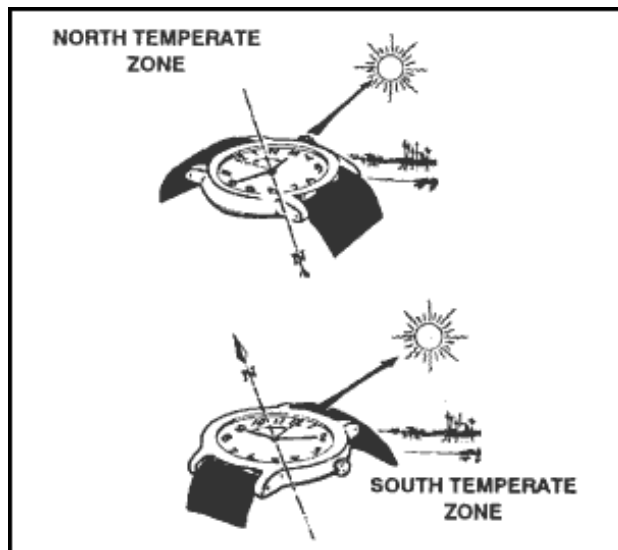
(d) The shadow-tip system is not intended for use in polar regions, which the Department of Defense defines as being above 60° latitude in either hemisphere. Distressed persons in these areas are advised to stay in one place so that search/rescue teams may easily find them. The presence and location of all aircraft and ground parties in polar regions are reported to and checked regularly by governmental or other agencies, and any need for help becomes quickly known.

#### b. Watch Method.

(1) A watch can be used to determine the approximate true north and true south. In the north temperate zone only, the hour hand is pointed toward the sun. A south line can be found midway between the hour hand and 1200 hours, standard time. If on daylight saving time, the north-south line is found between the hour hand and 1300 hours. If there is any doubt as to which end of the line is north, remember that the sun is in the east before noon

and in the west after noon.

(2) The watch may also be used to determine direction in the south temperate zone; however, the method is different. The 1200-hour dial is pointed toward the sun, and halfway between 1200 hours and the hour hand will be a north line. If on daylight saving time, the north line lies midway between the hour hand and 1300 hours (Figure 9-8).



**Figure 9-8. Determining direction by using a watch.**

(3) The watch method can be in error, especially in the lower latitudes, and may cause *circling*. To avoid this, make a shadow clock and set your watch to the time indicated. After traveling for an hour, take another shadow-clock reading. Reset your watch if necessary.

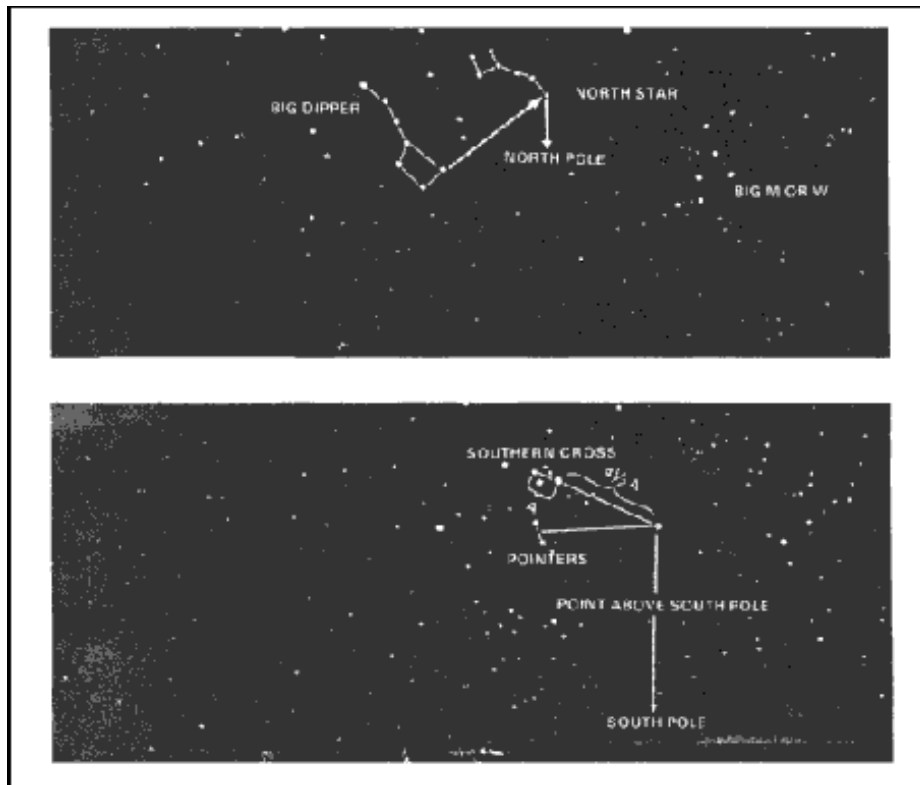
### c. Star Method.

(1) Less than 60 of approximately 5,000 stars visible to the eye are used by navigators. The stars seen as we look up at the sky at night are not evenly scattered across the whole sky. Instead they are in groups called constellations.

(2) The constellations that we see depends partly on where we are located on the earth, the time of the year, and the time of the night. The night changes with the seasons because of the journey of the earth around the sun, and it also changes from hour to hour because the turning of the earth makes some constellations seem to travel in a circle. But there is one star that is in almost exactly the same place in the sky all night long every night. It is the North Star, also known as the Polar Star or Polaris.

(3) The North Star is less than 1° off true north and does not move from its place because the axis of the earth is pointed toward it. The North Star is in the group of stars called the Little Dipper. It is the last star in the handle of the dipper. There are two stars in the Big Dipper, which are a big help when trying to find the North Star. They are called the Pointers, and an imaginary line drawn

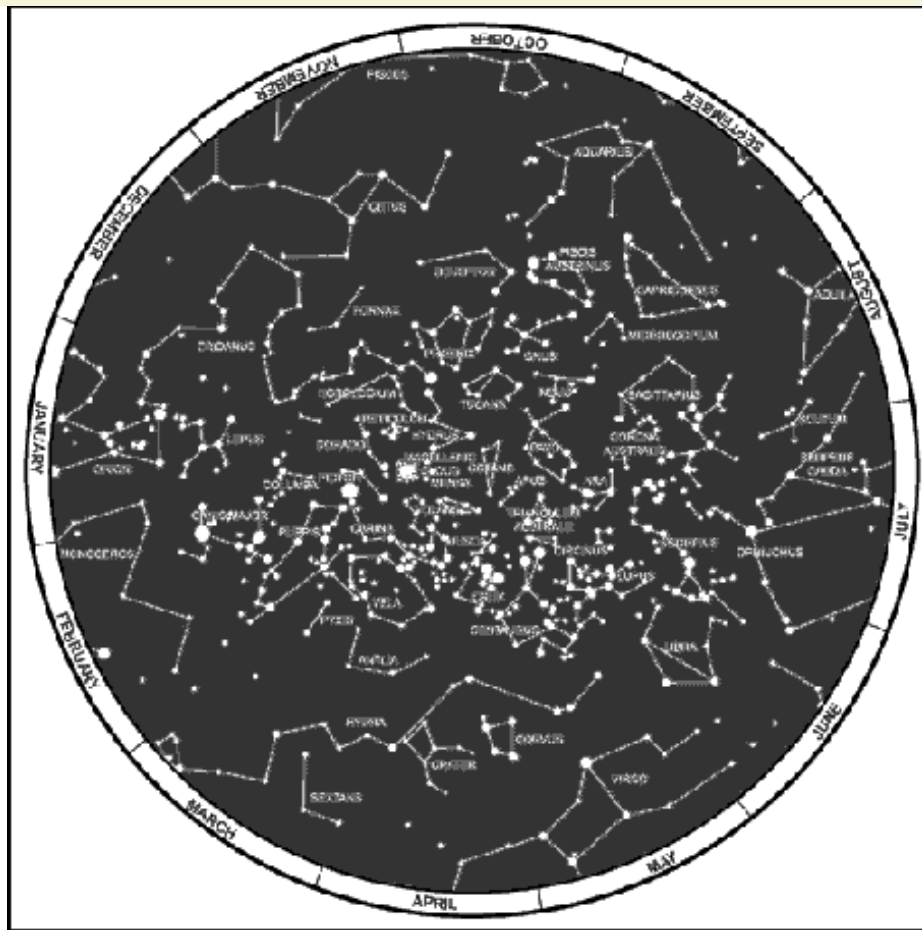
through them five times their distance points to the North Star. There are many stars brighter than the North Star, but none is more important because of its location. However, the North Star can only be seen in the northern hemisphere so it cannot serve as a guide south of the equator. The farther one goes north, the higher the North Star is in the sky, and above latitude  $70^\circ$ , it is too high in the sky to be useful (Figure 9-9).



**Figure 9-9. Determining direction by the North Star and Southern Cross.**

(4) Depending on the star selected for navigation, azimuth checks are necessary. A star near the north horizon serves for about half an hour. When moving south, azimuth checks should be made every 15 minutes. When traveling east or west, the difficulty of staying on azimuth is caused more by the likelihood of the star climbing too high in the sky or losing itself behind the western horizon than it is by the star changing direction angle. When this happens, it is necessary to change to another guide star. The Southern Cross is the main constellation used as a guide south of the equator, and the above general directions for using north and south stars are reversed. When navigating using the stars as guides, the user must know the different constellation shapes and their locations throughout the world (Figure 9-10 and Figure 9-11).





**Figure 9-11. Constellations, southern hemisphere.**

For more field-expedient methods check out [Wilderness Survival](#)

[Back to Navigation Equipment and Methods](#)

Check out the **Amazon Coupons** before you buy.

Copyright © 2001-2002 Jalic LLC. All Rights Reserved.

[Disclaimer](#) | [Privacy Policy](#) | [Contact Us](#)



# Wilderness Survival

[Take Our Survival Quiz, Click Here!](#)

[Wilderness Survival Home](#)

## Wilderness Survival

- [1. Introduction](#)
- [2. Psychology of Survival](#)
- [3. Survival Kits & Planning](#)
- [4. Survival Medicine](#)
- [5. Shelters](#)
- [6. Water Procurement](#)
- [7. Firecraft](#)
- [8. Food Procurement](#)
- [9. Survival Use of Plants](#)
- [10. Poisonous Plants](#)
- [11. Dangerous Animals](#)
- [12. Weapons, Tools, and Equipment](#)
- [13. Desert Survival](#)
- [14. Tropical Survival](#)
- [15. Cold Weather Survival](#)
- [16. Sea Survival](#)
- [17. Water Crossings](#)
- [18. Wilderness Navigation](#)
- [19. Signaling Techniques](#)
- [20. Hostile Areas](#)
- [21. Camouflage](#)
- [22. Contact With People](#)
- [23. Survival in Man-Made Hazards](#)

## Survival Reference

- [A. Survival Kits](#)
- [B. Edible and Medicinal Plants](#)
- [C. Poisonous Plants](#)
- [D. Dangerous Insects and Arachnids](#)
- [E. Poisonous Snakes and Lizards](#)
- [F. Dangerous Fish and Mollusks](#)
- [G. Clouds: Foretellers of Weather](#)
- [H. Survive Outdoors](#)

## Marketplace

[Tents](#)

**GPS & Navigation**

**First Aid & Safety**

**Knives & Tools**

**Wilderness Survival Books**

**Hiking Boots**

**Backpacks**

**Lights & Laterns**

Survival  
Top  
Sites

## Train to Survive

CBS's Survivor has become one of the most watched television shows in America. One of the reasons for this show's success is that there is an adventurer in all of us and since we all cannot be in a survival situation we like to live vicariously through the people on the show.

But don't make the mistake of thinking that being in a survival situation would be fun. Wilderness Survival is not a game, there is no reward challenges, and there is no immunity. How do you think you would fare in a survival situation? Could you build a shelter? Could you light a fire without matches? Could you forage for food and purify water? In real life you don't have luxury items, you don't get tarps and matches and camping supplies. In real life you may not have any tools except your own two hands. If you were stranded in the wilderness would you end up a survivor?

Don't worry about those questions. Instead take action and educate yourself on survival techniques. Nature is unforgiving and you must be prepared to fight to stay alive. The contents of this website are taken from actual US Army training manuals, this is the same material used to train the best army in the world. You will not find a more complete resource on Wilderness Survival. So prepare yourself because one day you may need it.

## Bushmaster Survival Knife

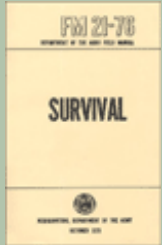


This sharp multi-functional knife has a 10" blade and 5 1/4" grip. Between the heavy nylon sheath pouches and the hollow knife handle, you have room for a compass, G.I. can opener, sharpening stone, animal snare, snake bite kit, flashlight, matches, surgical blade, sewing needles, Band-Aids, a magnifier, and fishing hooks, line, and sinkers -- **all of which is included**. This is your one stop



functional survival kit. **Sorry, international shipping is not available.**

List Price: \$61.99  
Your Price: \$49.99



### Buy The Book This Site Is Based On

U.S. Army Field Manual 21-76 is the source material for this website. The U.S. Army Survival Manual covers a broad area of proven survival techniques. Topics include survival at sea, in jungles, desert and arctic regions. This manual, which is used throughout the U.S. Military, contains many useful illustrations and diagrams. Other topics include the procurement of potable water, food from animals and edible plants, finding directions using the sun or stars, and locating or making shelter. This is the finest, most proven book available on wilderness survival. It also includes guides on surviving a chemical, nuclear, or biological attack.

[Click here to buy it now on Amazon.com](#)

Check out the [Amazon Coupons](#) first to get the best deal.

*As seen in:*

*U.S. News and World Report  
Best of the Web - Site of the Week 8/6/01*

*Discovery Channel Canada  
One Week in the Wilderness*

Copyright © 2001-2002 Jalic LLC. All Rights Reserved.  
[Disclaimer](#) | [Privacy Policy](#) | [Advertise Here](#) | [Contact Us](#)

# Fitness Training

## Fitness Training Home

Fitness introduction

Cardiorespiratory

Fitness

Muscular Endurance  
and Strength

Flexibility

Nutrition and Fitness

Environmental

Considerations

Injuries and Prevention

Body Mass Index

### Marketplace

Aerobic Equipment

Fitness Accessories

Strength Training

Weight Loss Products

Athletic Apparel

Nutritional

Supplements

## It's Time to Get Fit

Fitness problems such as obesity and overweight have reached truly epidemic proportions in the United States. In the last 20 years, obesity rates have increased by more than 60 percent among adults. In 1999, 61 percent of the adult population was either overweight or obese. The obesity epidemic impacts other diseases as well. For example, the incidence of type 2 diabetes, a major consequence of obesity, is on the rise. Among U.S. adults, diagnosed diabetes increased 49 percent from 1990 to 2000.

The rate of increase in overweight among young people has been even steeper. This is particularly troubling since many of the behaviors that lead to adult obesity are established during childhood. Just 10 years ago, type 2 diabetes was virtually unknown in children and adolescents. Indeed, the medical community commonly referred to the condition as "adult onset diabetes." Today, it accounts for almost 50 percent of new cases of pediatric diabetes in some communities. Medical complications associated with obesity in children can lead to hospitalizations for type 2 diabetes, sleep apnea, and asthma. Since 1980, the percentage of children who are overweight has nearly doubled, and the percentage of adolescents who are overweight has nearly tripled. About 8 million young Americans, almost 15 percent of all children, are overweight.

Americans young and old should incorporate regular physical activity into their everyday lives. This does not necessarily mean joining an expensive gym or committing to a rigorous exercise or training routine. It is sufficient to choose activities that fit into your daily routine that speed your heart rate and breathing, or increase your strength and flexibility. Examples include walking to work, gardening, taking extra stairs, or mowing the lawn with a push mower. Besides building strength and aerobic fitness, regular exercise relieves stress, provides motivation, promotes relaxation, and facilitates sleep. Such activity reduces the risk of dying of coronary heart disease and decreases the risk for colon cancer, diabetes, and high blood pressure.

Regular physical activity is important throughout life. Healthy lifestyles are more influential than genetic factors in avoiding deterioration traditionally associated with aging. The growing number of older Americans places increasing demands on the public health system and on medical and social services. Currently, almost one-third of total U.S. health care expenditures are for older adults. These expenditures are largely due to treatment and care of chronic diseases, and the cost associated with many of these conditions could be reduced through regular physical activity.

For children, almost any physical activity is sufficient as long as they are

moving. Playing actively or participating in athletic or physical fitness activities during school, running, biking, jumping rope, and dancing— instead of watching television or playing video games— all provide children with the kinds of activity they need.

Check out the **Amazon Coupons** before you buy.

Copyright © 2001-2002 Jalic LLC. All Rights Reserved.

**[Disclaimer](#) | [Privacy Policy](#) | [Contact Us](#)**



**Orienteering Home**

## What is Orienteering?

**The Sport:**

Orienteering is a competitive form of land navigation. It is for all ages and degrees of fitness and skill. It provides the suspense and excitement of a treasure hunt. The object of orienteering is to locate control points by using a map and compass to navigate through the woods. The courses may be as long as 10 km.

- **Orienteering History**

- **Orienteering**

**Overview**

- **Course Setup**

- **Officials**

- **Start/Finish Areas**

- **Course Safety**

- **Control Point**

**Guidelines**

- **Map Symbols**

- **Orienteering**

**Techniques**

- **Civilian Orienteering**

This site aims to inform you about the sport of Orienteering, you can find that information at the left under "The Sport." We also have information on learning how to read maps and perform land navigation using such tools as a compass. This information is based off U.S. Army training and is what you need to know to be an orienteer.

**The Skills:**

- **Maps**

- **Marginal Information**

**and Symbols**

- **Grids**

- **Scale and Distance**

- **Direction**

- **Overlays**

- **Aerial Photographs**

- **Navigation**

**Equipment and**

**Methods**

- **Elevation and Relief**

- **Terrain Association**

- **Navigation in**

**Different Types of**

**Terrain**

- **Field Sketching**

- **Map Folding**

**Techniques**

- **Units of Measure and**

**Conversion Factors**

Check out the **Amazon Coupons** before you buy.

Copyright © 2001-2002 Jalic LLC. All Rights Reserved.

**Disclaimer | Privacy Policy | Contact Us**





[Orienteering Home](#)

## Orienteering History

### The Sport:

- [Orienteering History](#)
- [Orienteering](#)

### Overview

- [Course Setup](#)
- [Officials](#)
- [Start/Finish Areas](#)
- [Course Safety](#)
- [Control Point](#)

### Guidelines

- [Map Symbols](#)
- [Orienteering](#)

### Techniques

- [Civilian Orienteering](#)

Orienteering began in Scandinavia in the nineteenth century. It was primarily a military event and was part of military training. It was not until 1919 that the modern version of orienteering was born in Sweden as a competitive sport. Ernst Killander, its creator, can be rightfully called the father of orienteering. In the early thirties, the sport received a technical boost with the invention of a new compass, more precise and faster to use. The Kjellstrom brothers, Bjorn and Alvan, and their friend, Brunnar Tillander, were responsible for this new compass. They were among the best Swedish orienteers of the thirties, with several individual championships among them. Orienteering was brought into the US in 1946 by Bjorn Kjellstrom.

### The Skills:

- [Maps](#)
- [Marginal Information and Symbols](#)

- [Grids](#)
- [Scale and Distance](#)
- [Direction](#)
- [Overlays](#)

- [Aerial Photographs](#)
- [Navigation](#)

### Equipment and

### Methods

- [Elevation and Relief](#)
- [Terrain Association](#)
- [Navigation in](#)

### Different Types of Terrain

- [Field Sketching](#)
- [Map Folding](#)

### Techniques

- [Units of Measure and Conversion Factors](#)

Check out the [Amazon Coupons](#) before you buy.

Copyright © 2001-2002 Jalic LLC. All Rights Reserved.

[Disclaimer](#) | [Privacy Policy](#) | [Contact Us](#)







[Orienteering Home](#)

## Orienteering Overview

### The Sport:

- [Orienteering History](#)
- [Orienteering Overview](#)

### Overview

- [Course Setup](#)
- [Officials](#)
- [Start/Finish Areas](#)
- [Course Safety](#)
- [Control Point](#)

### Guidelines

- [Map Symbols](#)
- [Orienteering Techniques](#)

### Techniques

- [Civilian Orienteering](#)

### The Skills:

- [Maps and Symbols](#)
- [Marginal Information](#)

- [Grids](#)
- [Scale and Distance](#)
- [Direction](#)
- [Overlays](#)

- [Aerial Photographs](#)
- [Navigation](#)

### Equipment and Methods

- [Elevation and Relief](#)
- [Terrain Association](#)
- [Navigation in Different Types of Terrain](#)

### Different Types of Terrain

- [Field Sketching](#)
- [Map Folding](#)

### Techniques

- [Units of Measure and Conversion Factors](#)

Each orienteer is given a 1:50,000 topographic map with the various control points circled. Each point has a flag marker and a distinctive punch that is used to mark the scorecard. Competitive orienteering involves running from checkpoint to checkpoint. It is more demanding than road running, not only because of the terrain, but because the orienteer must constantly concentrate, make decisions, and keep track of the distance covered. Orienteering challenges both the mind and the body; however, the competitor's ability to think under pressure and make wise decisions is more important than speed or endurance.

The orienteering area should be on terrain that is heavily wooded, preferably uninhabited, and difficult enough to suit different levels of competition. The area must be accessible to competitors and its use must be coordinated with appropriate terrain and range control offices.

a. The ideal map for an orienteering course is a multi-colored, accurate, large-scale topographic map. A topographic map is a graphic representation of selected man made and natural features of a part of the earth's surface plotted to a definite scale. The distinguishing characteristic of a topographic map is the portrayal of the shape and elevation of the terrain by contour lines.

b. For orienteering within the United States, large-scale topographic (topo) maps are available from the Defense Mapping Agency Hydrographic Topographic Center. The scale suitable for orienteering is 1:50,000 (DMA).

Check out the [Amazon Coupons](#) before you buy.

Copyright © 2001-2002 Jalic LLC. All Rights Reserved.

[Disclaimer](#) | [Privacy Policy](#) | [Contact Us](#)





# Orienteeing

## Orienteeing Home

### The Sport:

- **Orienteeing History**
- **Orienteeing**

### Overview

- **Course Setup**
- **Officials**
- **Start/Finish Areas**
- **Course Safety**
- **Control Point**

### Guidelines

- **Map Symbols**
- **Orienteeing**

### Techniques

- **Civilian Orienteeing**

### The Skills:

- **Maps**
- **Marginal Information and Symbols**
- **Grids**
- **Scale and Distance**
- **Direction**
- **Overlays**
- **Aerial Photographs**
- **Navigation**

### Equipment and

### Methods

- **Elevation and Relief**
- **Terrain Association**
- **Navigation in**

### Different Types of Terrain

- **Field Sketching**
- **Map Folding**

### Techniques

- **Units of Measure and Conversion Factors**

## Course Setup

The challenge for the course setter is to keep the course interesting, but never beyond the individual's or group's ability. General guidance is to select locations that are easily identifiable on the map and terrain, and accessible from several routes.

- a. Those who set up the initial event should study a map for likely locations of control points and verification of the locations. Better yet, they should coordinate with an experienced competitor in selecting the course.
- b. There are several forms of orienteeing events. Some of the most common are route, line, cross-country, and score orienteeing.

(1) **Route Orienteeing.** This form can be used during the training phase and in advanced orienteeing. In this type of event, a master or advanced competitor leads the group as they walk a route. The beginners trace the actual route walked on the ground on their maps. They circle the location of the different control points found along the walked route. When they finish, the maps are analyzed and compared. During training, time is not a factor. Another variation is when a course is laid out on the ground with markers for the competitor to follow. There is no master map, as the course is traced for the competitor by flags or markers. The winner of the event is the competitor who has successfully traced the route and accurately plotted the most control points on his map.

(2) **Line Orienteeing.** At least five control points are used during this form of orienteeing training. The competitor traces on his map a preselected route from a master map. The object is to walk the route shown on the map, circling the control points on the map as they are located on the ground (Figure F-1).

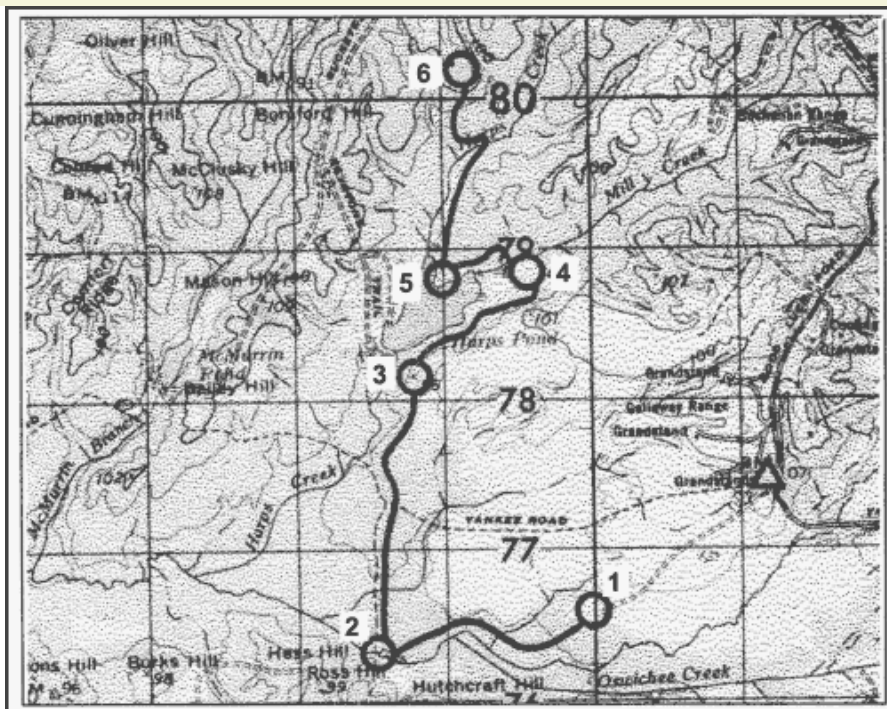


Figure F-1. Line orienteering.

(3) **Cross-Country Orienteering.** This is the most common type of orienteering competitions. It is sometimes called free or point orienteering and is considered to be the most competitive and intriguing of all events (Figure F-2). In this event, all competitors must visit the same controls in the same order. With the normal one-minute starting interval, it becomes a contest of route choice and physical skill. The winner is the contestant with the fastest time around the course.

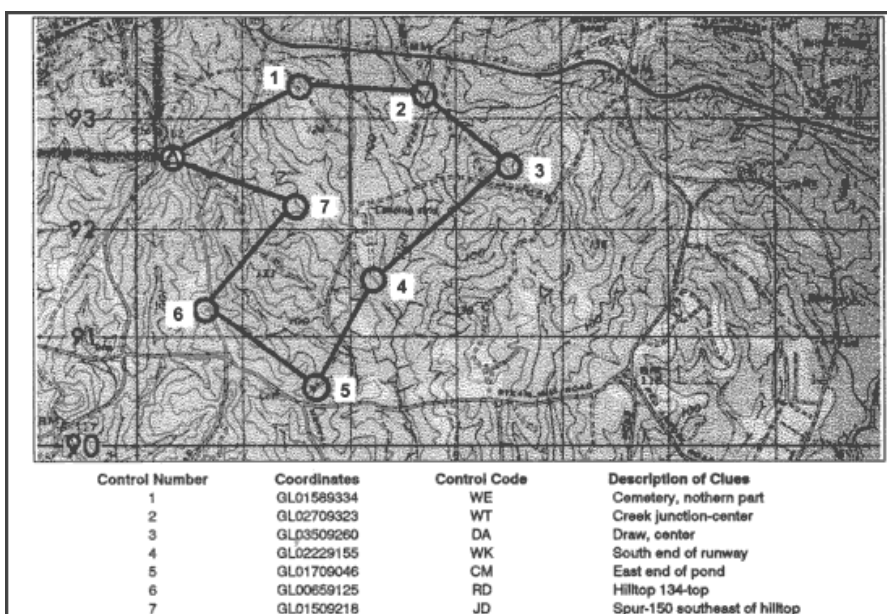


Figure F-2. A cross-country orienteering map.

(a) After selecting the control points for the course, determine the start and finish locations. The last control should be near the finish. In describing each control's



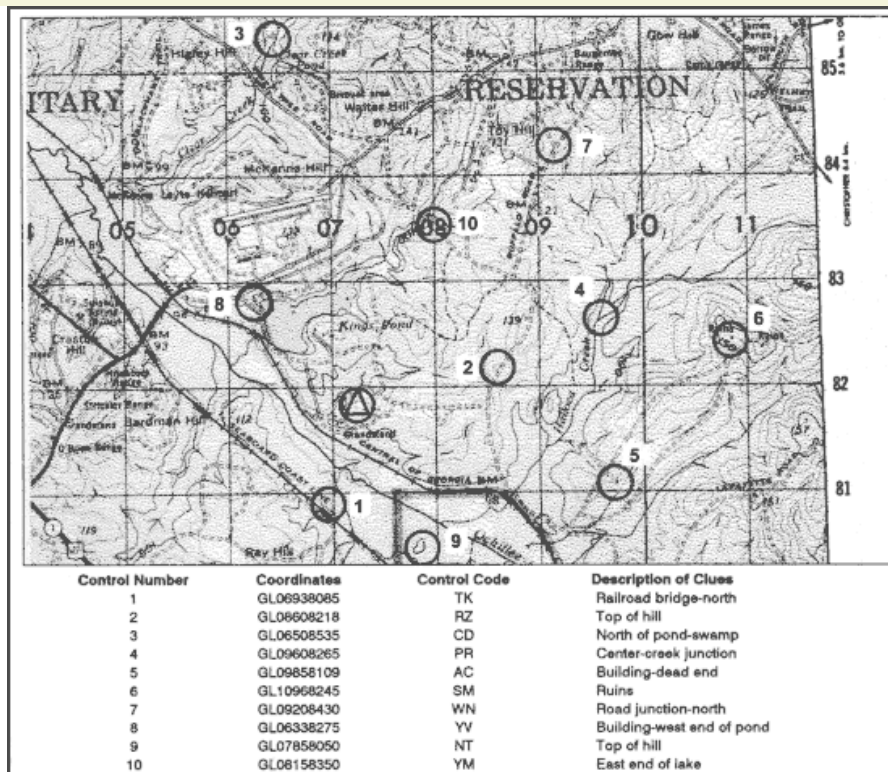
location, an eight-digit grid coordinate and a combination of two letters identifying the point (control code) should be included in each descriptive clue list that is normally given to each competitor at least two minutes before his start time.

(b) There are usually 6 to 12 control markers on the course in varying degrees of difficulty and distances apart so that there are no easy, direct routes. Instead, each competitor is faced with many choices of direct but difficult routes, or of indirect but easier routes. Each control's location is circled, and the order in which each is to be visited is clearly marked on the master map. The course may be a closed transverse with start and finish collocated, or the start and finish may be at different locations. The length of the course and difficulty of control placement varies with the competitors' degree of expertise. Regardless of the class of event, all competitors must indicate on their event cards proof of visiting the control markers. Inked stamps, coded letters, or punches are usually used to do this procedure.

**NOTE:** The same orienteering range may serve in both cross-country and score events. However, a separate set of competitor maps, master maps, and event cards are necessary.

(4) **Score orienteering.** In this event, the area chosen for the competition is blanketed with many control points (Figure F-3). The controls near the start/finish point (usually identical in this event) have a low point value, while those more distant or more difficult to locate have a high point value. (See Figure F-6 for a sample card.) This event requires the competitor to locate as many control markers as he can within the specified time (usually 90 minutes). Points are awarded for each control visited and deducted for exceeding the specified time. The competitor with the highest point score is the winner.





**Figure F-3. A score orienteering map.**

(a) Conducting a score event at the start is basically the same as the cross-country event. The competitor is given a map and an event card. The event card lists all the controls with their different point values. When released to the master map, the competitor finds the circles and numbers indicating the location of all the controls listed on his event card. He copies all the red circles on his map. Then he chooses any route he wishes to take in amassing the highest possible point score in the time available. The course is designed to ensure that there are more control points than can possibly be visited in the allotted time. Again, each control marker visited must be indicated on the event card.

(b) It is important for the competitor to take time initially to plot the most productive route. A good competitor may spend up to 6 minutes in the master map area while plotting the ideal route.

(c) There is no reward for returning early with time still available to find more points, so the good competitor must be able to coordinate time and distance with his ability in land navigation in running the course.

Check out the **Amazon Coupons** before you buy.





[Orienteering Home](#)

The Sport:

- [Orienteering History](#)
- [Orienteering](#)

Overview

- [Course Setup](#)
- [Officials](#)
- [Start/Finish Areas](#)
- [Course Safety](#)
- [Control Point](#)

Guidelines

- [Map Symbols](#)
- [Orienteering](#)

Techniques

- [Civilian Orienteering](#)

The Skills:

- [Maps](#)
- [Marginal Information and Symbols](#)
- [Grids](#)
- [Scale and Distance](#)
- [Direction](#)
- [Overlays](#)
- [Aerial Photographs](#)
- [Navigation](#)

Equipment and Methods

- [Elevation and Relief](#)
- [Terrain Association](#)
- [Navigation in](#)

Different Types of Terrain

- [Field Sketching](#)
- [Map Folding](#)

Techniques

- [Units of Measure and Conversion Factors](#)

## Officials

The same officials can be used at the start and finish. More officials or assistants can be used; the following material lists the minimum that can be used for a competition. They include the following:

a. **At The Start.**

- (1) **Course Organizer**—Briefs the orienteers in the assembly area, issues event cards and maps, and calls orienteers forward to start individually.
- (2) **Recorder**—Records orienteer's name and start time on recorder's sheet, checks orienteer's name and start number on his event card, and issues any last-minute instructions.
- (3) **Timer**—Controls the master clock and releases the orienteers across the start line at their start time (usually at one-minute intervals) to the master map area.

b. **At The Finish.**

- (1) **Timer**—Records finish time of each orienteer on the orienteer's event card and passes card to recorder.
- (2) **Recorder**—Records finish time of each orienteer on the orienteer's event card and passes card to recorder.
- (3) **Course Organizer**—Verifies correctness of names, finish times, and final score; posts orienteers' positions on results board; and accounts for all orienteers at the end of event.

Check out the [Amazon Coupons](#) before you buy.

Copyright © 2001-2002 Jalic LLC. All Rights Reserved.

[Disclaimer](#) | [Privacy Policy](#) | [Contact Us](#)





# Orienteeing

## Orienteeing Home

### The Sport:

- Orienteeing History
- Orienteeing

### Overview

- Course Setup
- Officials
- Start/Finish Areas
- Course Safety
- Control Point

### Guidelines

- Map Symbols
- Orienteeing

### Techniques

- Civilian Orienteeing

### The Skills:

- Maps
- Marginal Information and Symbols

- Grids
- Scale and Distance
- Direction
- Overlays

- Aerial Photographs
- Navigation

### Equipment and Methods

- Elevation and Relief
- Terrain Association
- Navigation in

### Different Types of Terrain

- Field Sketching
- Map Folding

### Techniques

- Units of Measure and Conversion Factors

## Start/Finish Areas

The layout of the start/finish areas for orienteeing events is basically the same for all forms.

a. **Assembly Area.** This is where orientees register and receive instructions, maps, event cards, and start numbers. They may also change into their orienteeing clothes if facilities are available, study their maps, and fill out their event cards here. Sanitation facilities should be available in this area.

b. **Start.** At the start, the orienteer reports to the recorder and timer's table to be logged in by the recorder and released by the timer.

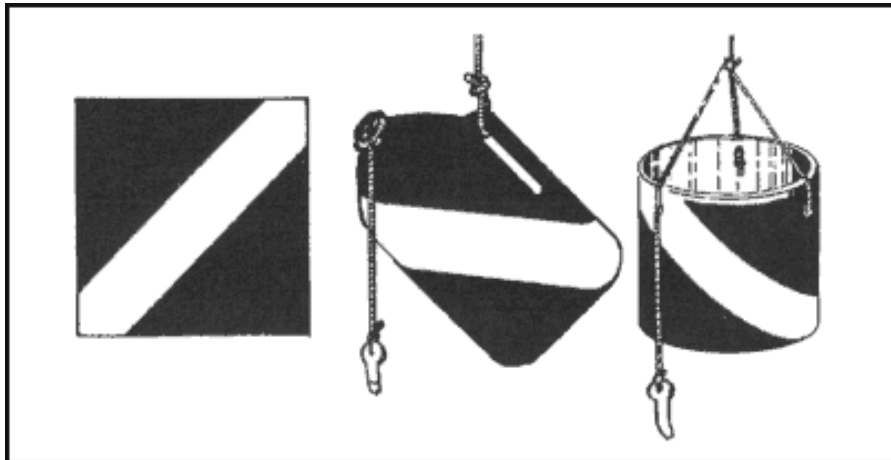
c. **Master Map Area.** There are three to five master maps 20 to 50 meters from the start. When the orienteer arrives at this area, he must mark his map with all the course's control points. Having done this, he must decide on the route that he is to follow. The good orienteer takes the time to orient his map and carefully plot his route before rushing off. It is a good idea to locate the master map area out of sight of the start point to preclude orientees tracking one another.

d. **Equipment.** The following is a list of equipment needed by the host of an orienteeing event:

- Master maps, three to five, mounted.
- Competitor maps, one each.
- Event cards, one each.
- Recorder's sheets, two.
- Descriptive clue cards, one each.
- Time clocks, two.
- Rope, 100 to 150 feet, with pegs for finish tunnel.
- Card tables, one or two.
- Folding chairs, two or three.

- Results board.
- Control markers, one per point.
- Extra compasses.
- Whistle, for starting.
- First aid kit.
- Colored tape or ribbon for marking route to master map and from last control point to finish.

e. **Control Markers.** These are orange-and-white markers designating each control point (Figure F-4). Ideally, they should have three vertical square faces, forming a triangle with the top and bottom edges. Each face should be 12 inches on a side and divided diagonally into red and white halves or cylinders (of similar size) with a large, white, diagonal stripe dividing the red cylinder. For economy or expediency, 1-gallon milk cartons, 5-gallon ice cream tubs, 1-gallon plastic bleach bottles, or foot-square plaques, painted in the diagonal or divided red and white colors of orienteering, may be used.



**Figure F-4. Control markers.**

(1) Each marker should have a marking or identification device for the orienteer to use to indicate his visit to the control. This marker may be the European-style punch pliers, a self-inking marker, different colored crayons at each point, different letter combinations, different number combinations, or different stamps or coupons. The marking device must be unique, simple, and readily transcribable to the orienteers' event cards.

(2) The control marker should normally be visible from at least 10 meters. It should not be hidden.

f. **Recorder's Sheets.** A suggested format for the recorder's sheet is de/imagested in Figure F-5.



RECORDER'S SHEET							
NAME	No.	Team-Class	Start Time	Finish Time	Time Taken	Controls Missed	Position

**Figure F-5. Recorder's sheet.**

g. **Event Card.** The event card can be made before the event and should be as small as possible, as it is carried by the competitor. It must contain the following items: name, start number, start time, finish time, total time, place, and enough blocks for marking the control points. As indicated earlier, it may also contain a listing of descriptive clues (Figure F-6).

CROSS-COUNTRY ORIENTEERING TEAM					
NAME _____	COMPANY _____	COURSE _____	TEAM _____		
NAME _____	COMPANY _____	START TIME _____	FINISH TIME _____		
CHECKPOINTS			DESCRIPTION CLUES		
1	2				
3	4				
5	6				
NOTE: All control signs are located at eye level on trees.					
Total Value of Points _____					
Penalty Points _____					
Final Score _____					
<div style="border: 1px solid black; padding: 5px;"> <ol style="list-style-type: none"> <li>1. All work is individual team effort.</li> <li>2. You must not join with or coordinate with any other team.</li> <li>3. You must personally visit each point you indicate on your scorecard.</li> </ol> </div>					

**Figure F-6. Cross-country orienteering event card.**

h. **Results Board.** This board displays the orienteer's position in the event at the finish (Figure F-7). There are a variety of ways of displaying the results, from blackboard to ladder-like to a clothesline-type device where each orienteer's name, point score, and times are listed.

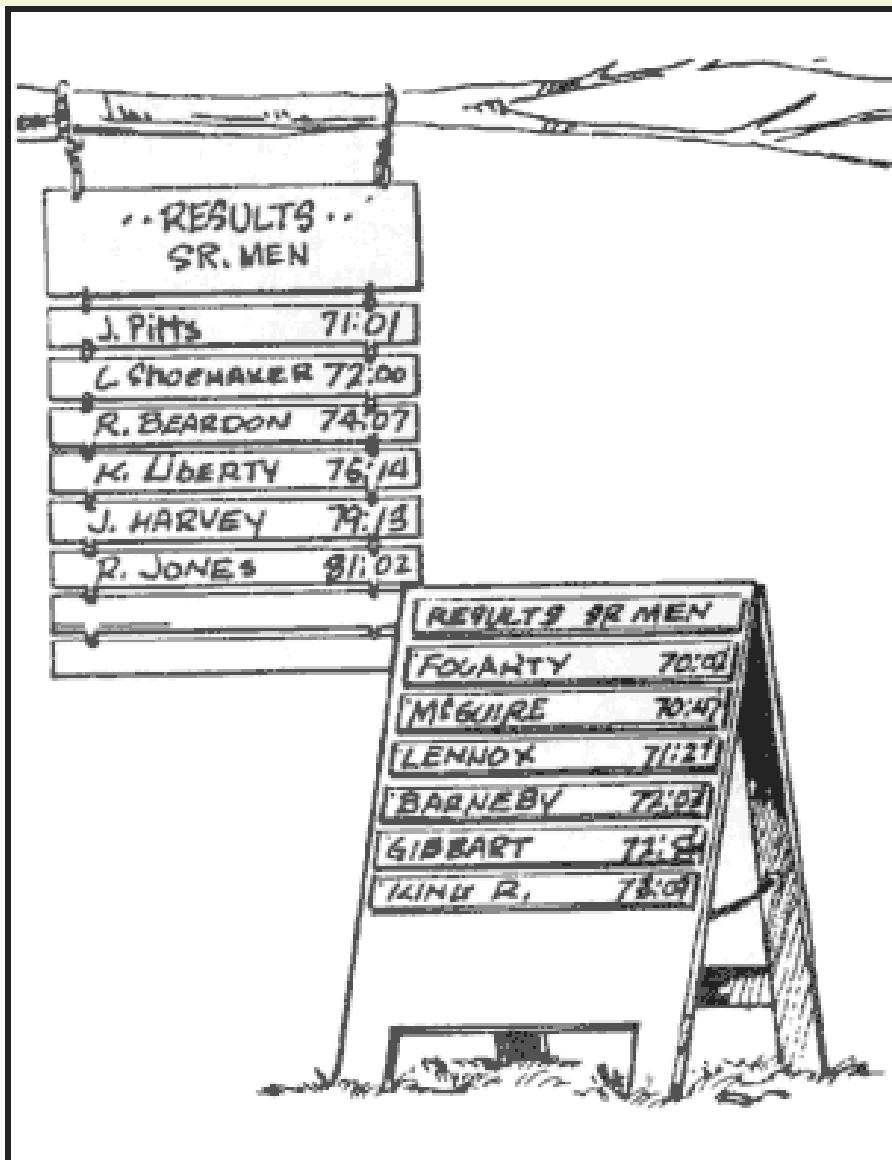


Figure F-7. Results board.

- i. **Clue Description Card.** These cards are prepared with the master maps after the course is set. They contain the descriptive clues for each control point, control code, grid coordinate references, returning time for competitors, removal times for each location, and panic azimuth (Figure F-8). The terminology on these must be identical to that listed in the definition section. These cards and the master maps must be kept confidential until the orienteers start the event.

SCORE ORIENTEERING EVENT			
NAME _____		COMPANY _____	
NAME _____		COMPANY _____	
TEAM _____			
STARTING TIME _____			
FINISHING TIME _____			
1	6	11	16
2	7	12	17
3	8	13	18
4	9	14	19
5	10	15	20
Total Value of Points			
Penalty Points			
Final Score			

LAND NAVIGATION II		
SCORE ORIENTEERING		
Description Class of Control Signs		
POINTS	VALUE	DESCRIPTION CLUE
1	10	SE SLOPE OF HILL 1211
2	10	CREST OF HILL 1211
3	10	SADDLE
4	10	EDGE OF RIDGE
5	10	NW CREST OF RIDGE
6	20	CREST OF HILL
7	20	CREST OF HILL
8	20	TOP OF SEVERE DRAW
9	20	SW CREST OF RIDGE
10	10	10 METERS N OF RJ
11	15	CREST OF NW SPUR OF RIDGE
12	10	HIGH POINT OF KNOLL
13	20	HIGH POINT ON HILL SIDE
14	20	NE CORNER OF BLACK CAP MOUNTAINS
15	20	CREST OF SMALL HILL
16	15	NW CREST OF RIDGE
17	10	50 METERS OFF RJ
18	10	10 METERS OFF ROAD
19	10	20 METERS SE OF RJ
20	10	CENTER OF RJ

**NOTE:** All control signs are located at eye level on trees.

1. ALL WORK IS INDIVIDUAL TEAM EFFORT.
2. YOU MUST NOT JOIN WITH OR COORDINATE WITH ANY OTHER TEAM.
3. YOU MUST PERSONALLY VISIT EACH POINT YOU INDICATE ON YOUR SCORECARD.

Figure F-8. Clue description card.

j. **Scoring.** The cross-country or free event is scored by the orienteer's time alone. All control points must be visited; failure to visit one results in disqualification. In this event, the fastest time wins.

(1) A variation that can be introduced for novices is to have a not-later-than return time at the finish and add minutes to the orienteer's final time for minutes late and control points not located.

(2) The score event requires the amassing of as many points as possible within the time limit. Points are deducted for extra time spent on the course, usually one point for each 10 seconds extra.

k. **Prizes.** A monetary prize is not awarded. A suggested prize for beginners is an orienteering compass or some other practical outdoor-sports item.

Check out the **Amazon Coupons** before you buy.

Copyright © 2001-2002 Jalic LLC. All Rights Reserved.

**Disclaimer | Privacy Policy | Contact Us**



[Orienteering Home](#)

## Course Safety

The Sport:

- [Orienteering History](#)
- [Orienteering](#)

Overview

- [Course Setup](#)
- [Officials](#)
- [Start/Finish Areas](#)
- [Course Safety](#)
- [Control Point](#)

Guidelines

- [Map Symbols](#)
- [Orienteering](#)

Techniques

- [Civilian Orienteering](#)

The Skills:

- [Maps](#)
- [Marginal Information and Symbols](#)
- [Grids](#)
- [Scale and Distance](#)
- [Direction](#)
- [Overlays](#)
- [Aerial Photographs](#)
- [Navigation](#)

Equipment and Methods

- [Elevation and Relief](#)
- [Terrain Association](#)
- [Navigation in](#)

Different Types of Terrain

- [Field Sketching](#)
- [Map Folding](#)

Techniques

- [Units of Measure and Conversion Factors](#)

A first aid kit must be available at the start and finish. One of the officials should be trained in first aid or have a medic at the event. Other safety measures include:

- a. **Control Points.** Locate the controls where the safety of the competitor is not jeopardized by hazardous terrain or other circumstances.
- b. **Safety Lane.** Have a location, usually linear, on the course where the competitor may go if injured, fatigued, or lost. A good course will usually have its boundary as a safety lane. Then a competitor can set a panic azimuth on the compass and follow it until he reaches the boundary.
- c. **Finish Time.** All orienteering events must have a final return time. At this time, all competitors must report to the finish line even if they have not completed the course.
- d. **Search-and-Rescue Procedures.** If all competitors have not returned by the end of the competition, the officials should drive along the boundaries of the course to /imagesk up the missing orienteers.

Check out the [Amazon Coupons](#) before you buy.

Copyright © 2001-2002 Jalic LLC. All Rights Reserved.

[Disclaimer](#) | [Privacy Policy](#) | [Contact Us](#)





[Orienteering Home](#)

The Sport:

- [Orienteering History](#)
- [Orienteering](#)

Overview

- [Course Setup](#)
- [Officials](#)
- [Start/Finish Areas](#)
- [Course Safety](#)
- [Control Point](#)

Guidelines

- [Map Symbols](#)
- [Orienteering](#)

Techniques

- [Civilian Orienteering](#)

The Skills:

- [Maps](#)
- [Marginal Information and Symbols](#)

- [Grids](#)
- [Scale and Distance](#)
- [Direction](#)
- [Overlays](#)

- [Aerial Photographs](#)
- [Navigation](#)

Equipment and

Methods

- [Elevation and Relief](#)
- [Terrain Association](#)
- [Navigation in](#)

Different Types of Terrain

- [Field Sketching](#)
- [Map Folding](#)

Techniques

- [Units of Measure and Conversion Factors](#)

## Control Point Guidelines

When the control point is marked on the map as well as on the ground, the description of that point is prefaced by the definite article **the**; for example, **the pond**. When the control point is marked on the ground but is not shown on the map, then the description of the point is prefaced by the indefinite article **a**; for example, **a trail junction**. In this case, care must be taken to ensure that no similar control exists within at least 25 meters. If it does, then either the control must not be used or it must be specified by a directional note in parentheses; for example, a depression (northern). Other guidelines include:

- a. Points of the compass are denoted by capital letters; for example, S, E, SE.
- b. Control points within 100 meters of each other or different courses are not to be on the same features or on features of the same description or similar character.
- c. For large (up to 75 meters across) features or features that are not possible to see across, the position of the control marker on the control point should be given in the instructions. For example, the east side of the pond; the north side of the building.
- d. If a very large (100 to 200 meters) feature is used, the control marker should be visible from most directions from at least 25 meters.
- e. If a control point is near but not on a conspicuous feature, this fact and the location of the marker should be clearly given; for example, 10 meters E of the junction. Avoid this kind of control point.
- f. Use trees in control descriptions only if they are prominent and a totally different species from those surrounding. Never use bushes and fauna as control points.
- g. Number control points in red on the master map.
- h. For cross-country events, join all control points by a red line indicating the course's shape.



Check out the **Amazon Coupons** before you buy.

Copyright © 2001-2002 Jalic LLC. All Rights Reserved.

**[Disclaimer](#) | [Privacy Policy](#) | [Contact Us](#)**



[Orienteering Home](#)

**The Sport:**

- [Orienteering History](#)
- [Orienteering](#)

**Overview**

- [Course Setup](#)
- [Officials](#)
- [Start/Finish Areas](#)
- [Course Safety](#)
- [Control Point](#)

**Guidelines**

- [Map Symbols](#)
- [Orienteering](#)

**Techniques**

- [Civilian Orienteering](#)

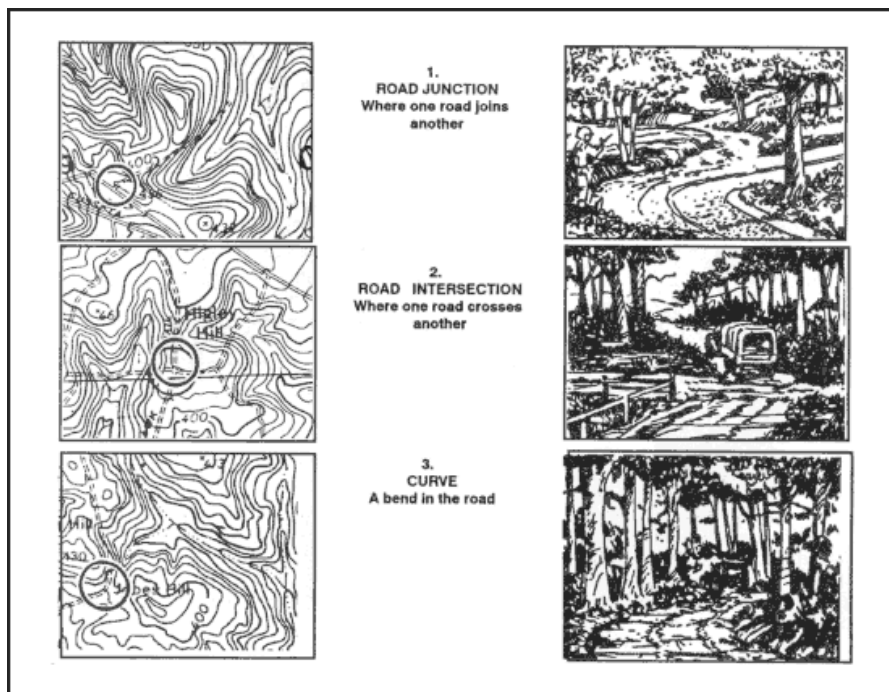
**The Skills:**

- [Maps](#)
  - [Marginal Information and Symbols](#)
  - [Grids](#)
  - [Scale and Distance](#)
  - [Direction](#)
  - [Overlays](#)
  - [Aerial Photographs](#)
  - [Navigation](#)
- Equipment and Methods**
- [Elevation and Relief](#)
  - [Terrain Association](#)
  - [Navigation in Different Types of Terrain](#)

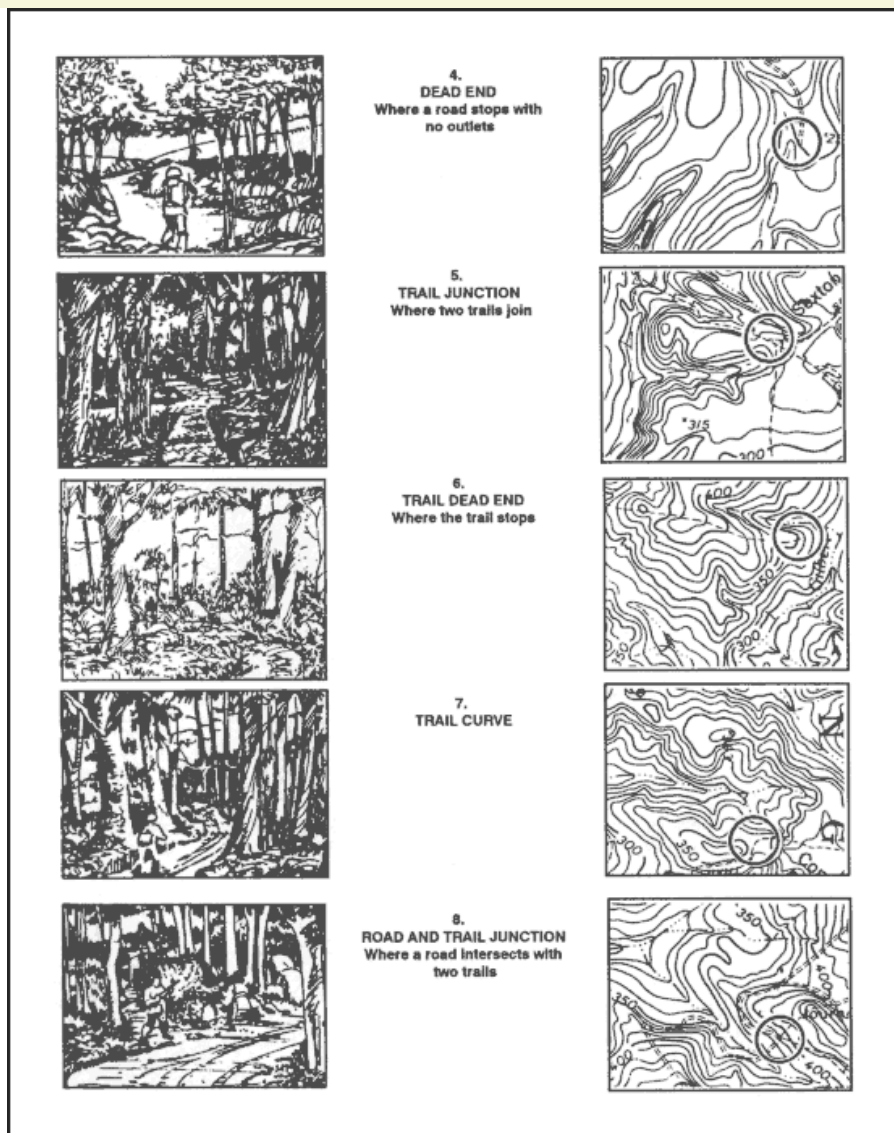
- [Field Sketching](#)
  - [Map Folding](#)
- Techniques**
- [Units of Measure and Conversion Factors](#)

## Map Symbols

The map symbols in [Figure F-9](#) are ty/imagesal topographic and cultural symbols that can be selected for orienteering control points. The map cutouts have been selected from DMA maps.



**Figure F-9.** Map symbols.



**Figure F-9. Map symbols (continued).**

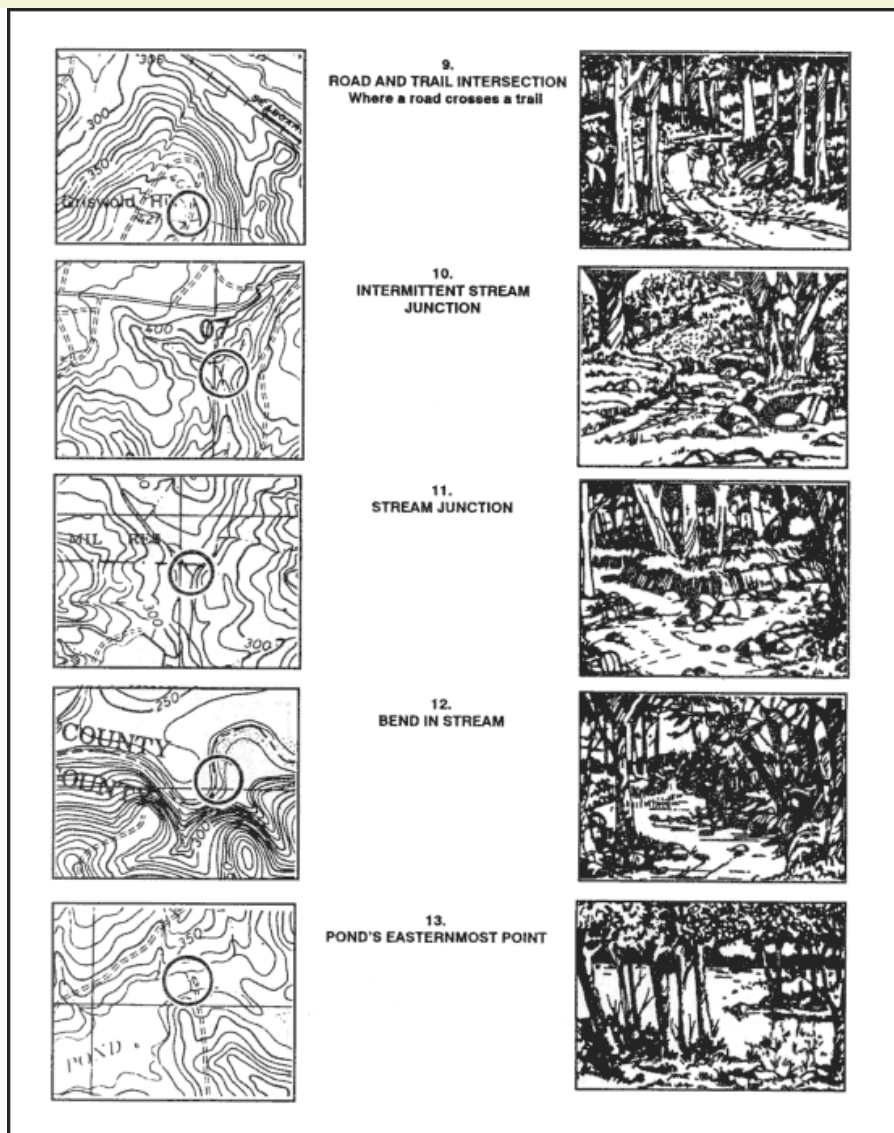


Figure F-9. Map symbols (continued).

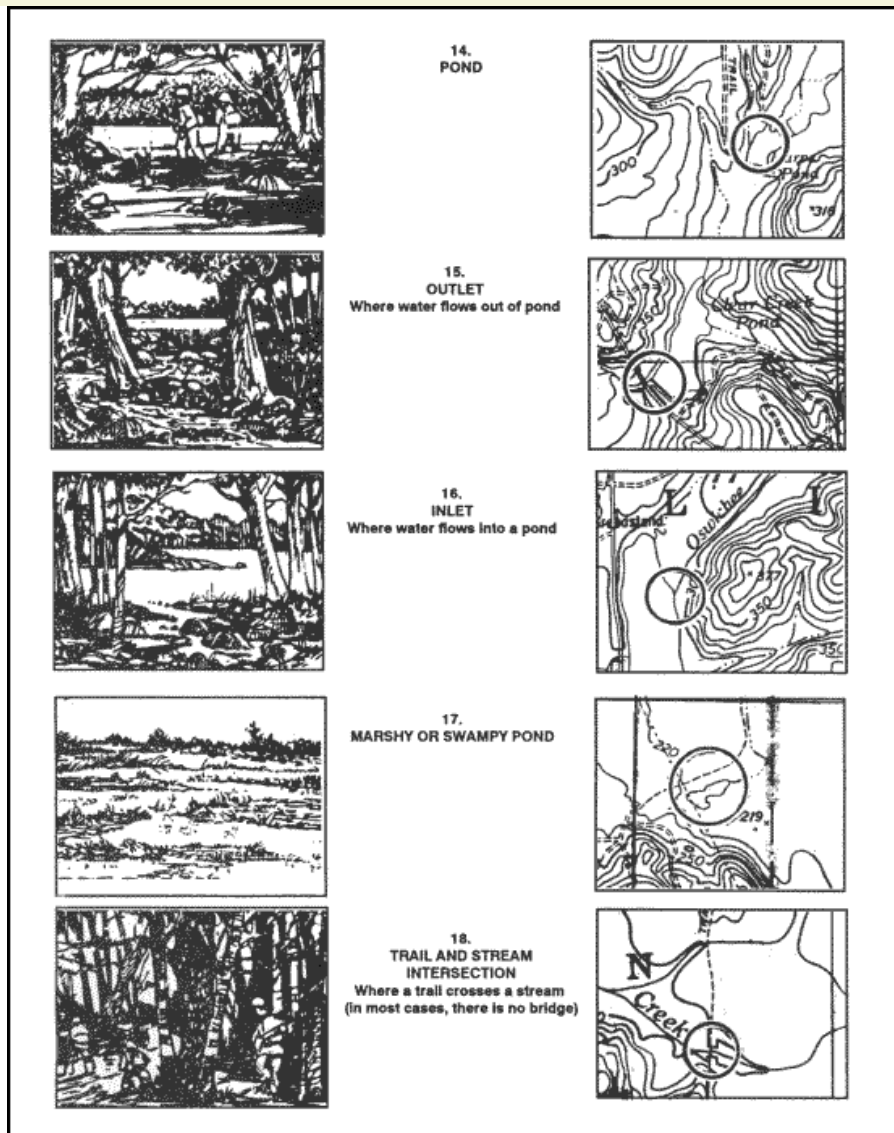


Figure F-9. Map symbols (continued).



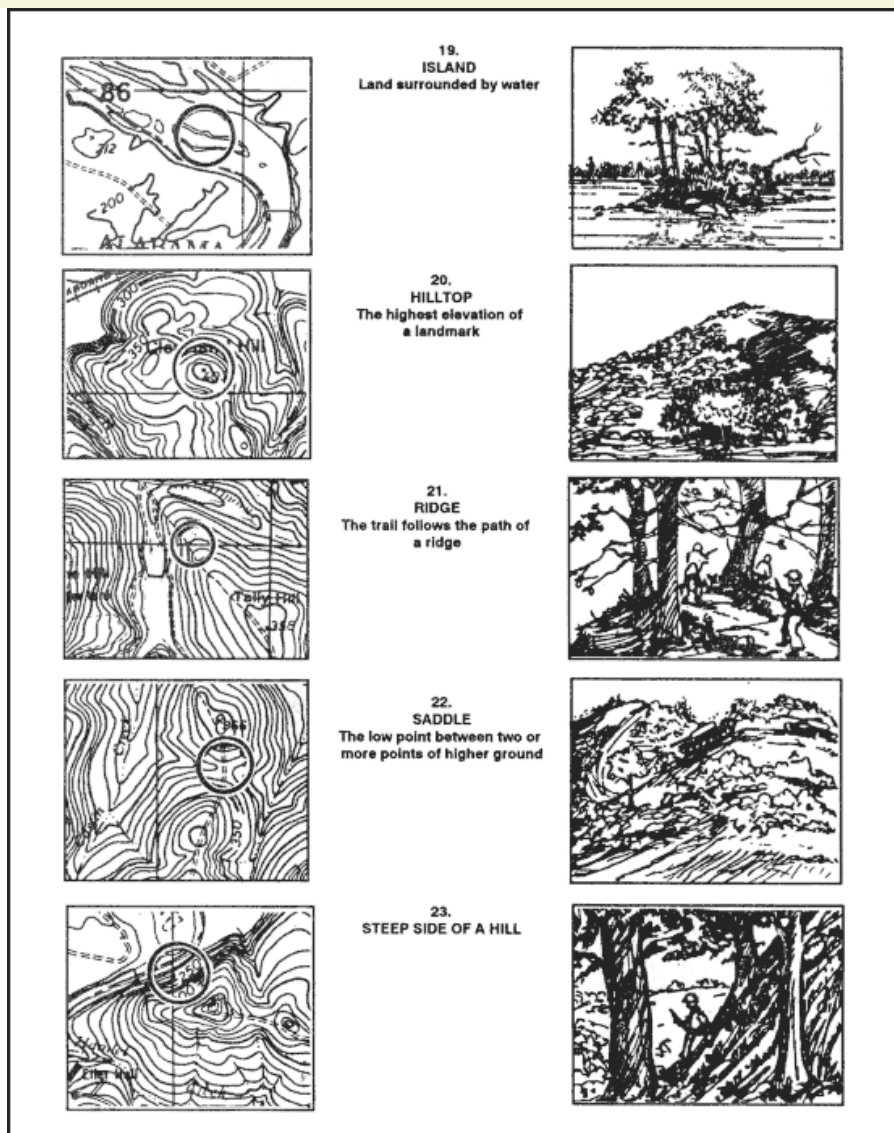


Figure F-9. Map symbols (continued).





Figure F-9. Map symbols (continued).

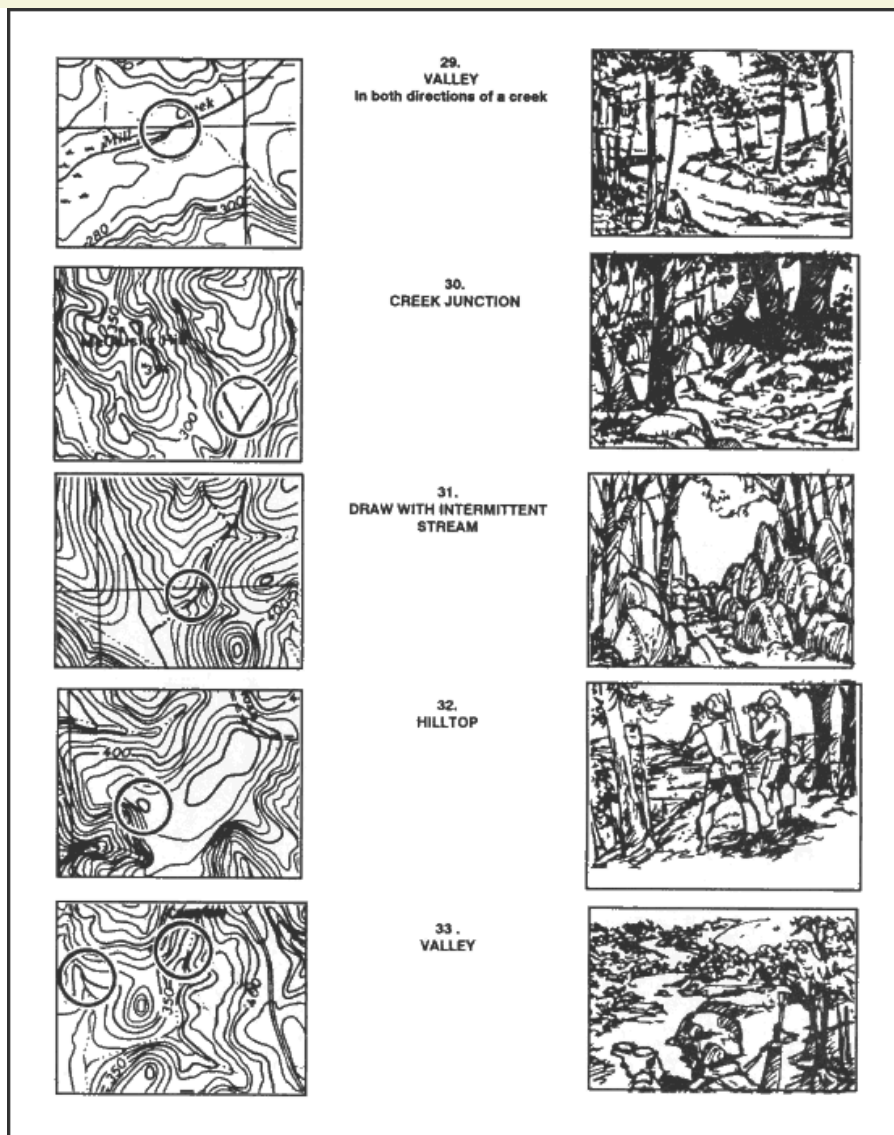


Figure F-9. Map symbols (continued).

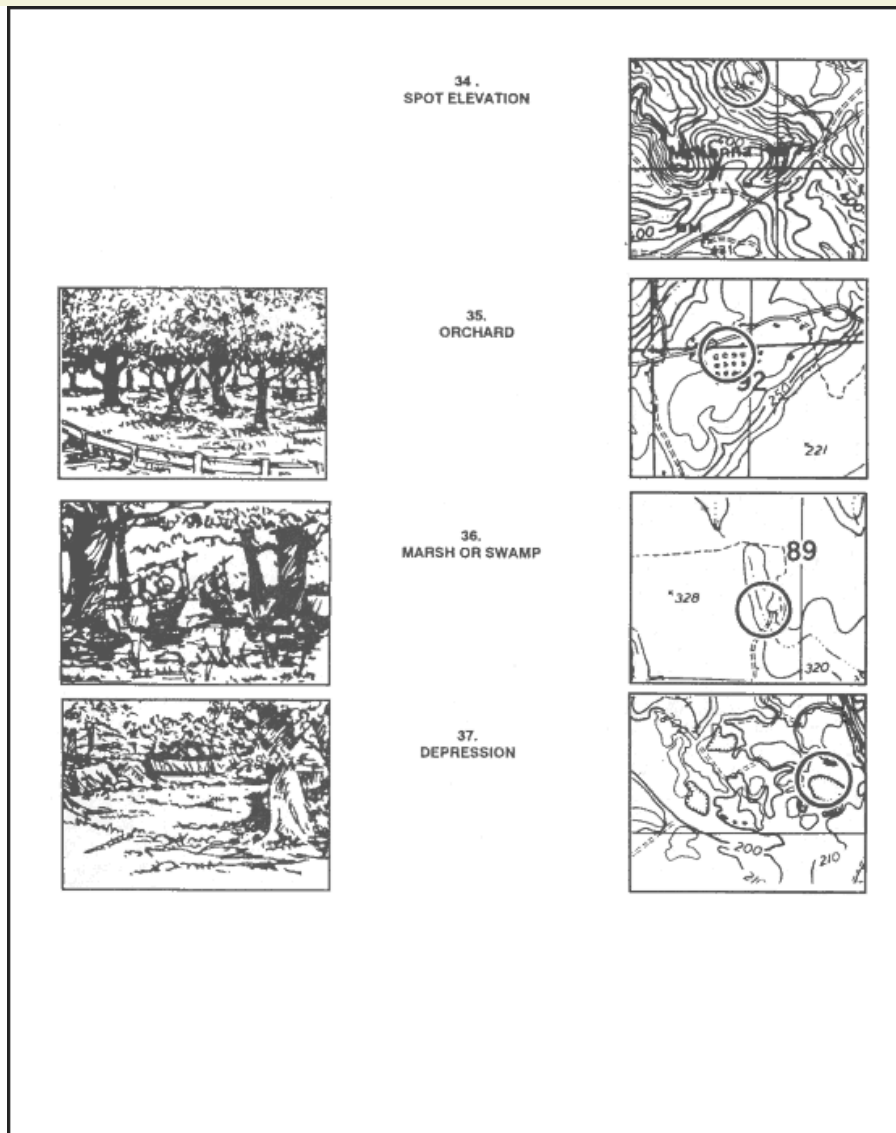


Figure F-9. Map symbols (continued).

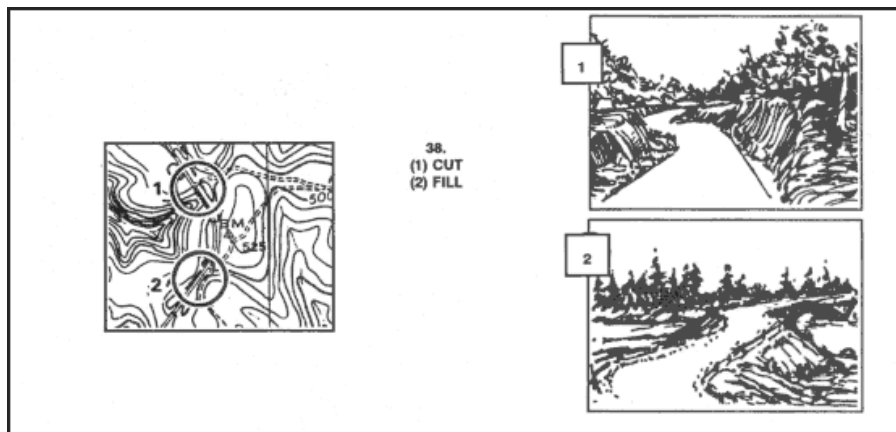


Figure F-9. Map symbols (continued).

Check out the **Amazon Coupons** before you buy.

Copyright © 2001-2002 Jalic LLC. All Rights Reserved.

**[Disclaimer](#) | [Privacy Policy](#) | [Contact Us](#)**





[Orienteering Home](#)

## Orienteering Techniques

### The Sport:

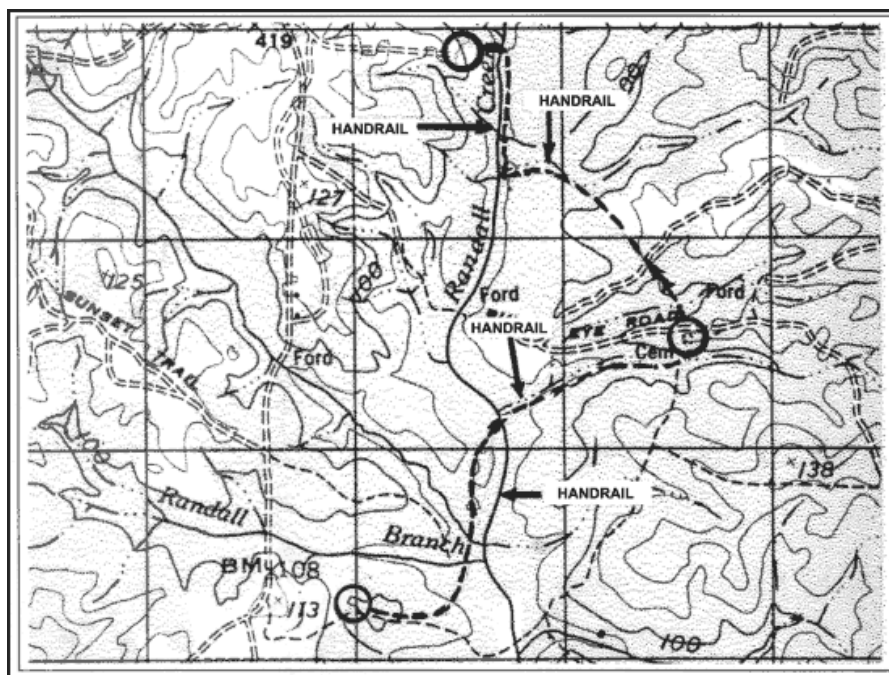
- [Orienteering History](#)
- [Orienteering Overview](#)
- [Course Setup](#)
- [Officials](#)
- [Start/Finish Areas](#)
- [Course Safety](#)
- [Control Point](#)
- [Guidelines](#)
- [Map Symbols](#)
- [Orienteering Techniques](#)
- [Civilian Orienteering](#)

### The Skills:

- [Maps](#)
- [Marginal Information and Symbols](#)
- [Grids](#)
- [Scale and Distance](#)
- [Direction](#)
- [Overlays](#)
- [Aerial Photographs](#)
- [Navigation](#)
- [Equipment and Methods](#)
- [Elevation and Relief](#)
- [Terrain Association](#)
- [Navigation in Different Types of Terrain](#)
- [Field Sketching](#)
- [Map Folding](#)
- [Techniques](#)
- [Units of Measure and Conversion Factors](#)

The orienteer should try not to use the compass to orient the map. The terrain association technique is recommended instead. The orienteer should learn the following techniques:

- a. **Pacing.** One of the basic skills that the orienteer should develop early is how to keep track of distance traveled while walking and running. This is done on a 100-meter pace course.
- b. **Thumbing.** This technique is very simple, but the map has to be folded small to use it. The orienteer finds his location on the map and places his thumb directly next to it. He moves from point to point on the ground without moving his thumb from his initial location. To find the new location, the only thing that he has to do is look at the map and use his thumb as a point of reference for his last location. This technique prevents the orienteer from looking all over the map for his location.
- c. **Handrails.** This technique enables the orienteer to move rapidly on the ground by using existing linear features (such as trails, fences, roads, and streams) that are plotted along his route. They can also be used as limits or boundaries between control points (Figure F-10).



**Figure F-10. Handrails.**

d. **Attack Points.** These are permanent known landmarks that are easily identified on the ground. They can be used as points of reference to find control points located in the woods. Some examples of attack points are stream junctions, bridges, and road intersections.

Check out the **Amazon Coupons** before you buy.

Copyright © 2001-2002 Jalic LLC. All Rights Reserved.

**Disclaimer | Privacy Policy | Contact Us**





[Orienteering Home](#)

## Civilian Orienteering

### The Sport:

Civilian orienteering is conducted under the guidelines of the United States Orienteering Federation with at least 70 clubs currently affiliated. Although civilian orienteering is a form of land navigation, the terms, symbols, and techniques are different from the military.

- [Orienteering History](#)

- [Orienteering](#)

### Overview

- [Course Setup](#)

- [Officials](#)

- [Start/Finish Areas](#)

- [Course Safety](#)

- [Control Point](#)

### Guidelines

- [Map Symbols](#)

- [Orienteering](#)

### Techniques

- [Civilian Orienteering](#)

### The Skills:

- [Maps](#)

- [Marginal Information and Symbols](#)

- [Grids](#)

- [Scale and Distance](#)

- [Direction](#)

- [Overlays](#)

- [Aerial Photographs](#)

- [Navigation](#)

### Equipment and

### Methods

- [Elevation and Relief](#)

- [Terrain Association](#)

- [Navigation in](#)

### Different Types of Terrain

- [Field Sketching](#)

- [Map Folding](#)

### Techniques

- [Units of Measure and Conversion Factors](#)

a. An expert military map reader/land navigator is by no means ready to compete in a civilian orienteering event. However, military experience in navigating on the ground and reading maps will help individuals to become good orienteers. Several orienteering practices and complete familiarization with the map symbols and terms before participating in a real orienteering event is recommended.

(1) **Map.** The standard orienteering map is a very detailed, 1:15,000-scale, colored topographical map. All orienteering maps contain only north-south lines that are magnetically drawn; this eliminates any declination conversions. Because of the absence of horizontal lines, grid coordinates cannot be plotted and therefore are not needed.

(2) **Symbols (Legend).** Despite standard orienteering symbols, the legend in orienteering maps has a tendency to change from map to map. A simple way to overcome this problem is to get familiar with the legend every time that a different map is used.

(3) **Scale.** The scale of orienteering maps is 1:15,000. This requires an immediate adjustment for the military land navigator, especially while moving from point to point. It takes a while for a person that commonly uses a 1:50,000 scale to get used to the orienteering map.

(4) **Contours.** The normal contour interval in an orienteering map is 5 meters. This interval, combined with the scale, makes the orienteering maps so meticulously detailed that a 1-meter boulder, a 3-meter shallow ditch, or a 1-meter depression will show on the map. This may initially shock a new orienteer.

(5) **Terms and Description of Clues.** The names of landforms are different from those commonly known to the military. For example, a valley or a draw is known as a reentrant; an intermittent stream is known as a dry ditch. These terms, with a description of clues indicating the position and location of the

control points, are used instead of grid coordinates.

b. The characteristics of the map, the absence of grid coordinates, the description of clues, and the methods used in finding the control points are what make civilian orienteering different from military land navigation.

Check out the **Amazon Coupons** before you buy.

Copyright © 2001-2002 Jalic LLC. All Rights Reserved.

**Disclaimer | Privacy Policy | Contact Us**



[Orienteering Home](#)

## Maps

### The Sport:

- [Orienteering History](#)
- [Orienteering](#)

### Overview

- [Course Setup](#)
- [Officials](#)
- [Start/Finish Areas](#)
- [Course Safety](#)
- [Control Point](#)

### Guidelines

- [Map Symbols](#)
- [Orienteering](#)

### Techniques

- [Civilian Orienteering](#)

*Cartography is the art and science of expressing the known physical features of the earth graphically by maps and charts. No one knows who drew, molded, laced together, or scratched out in the dirt the first map. But a study of history reveals that the most pressing demands for accuracy and detail in mapping have come as the result of military needs. Today, the complexities of tactical operations and deployment of troops are such that it is essential for all soldiers to be able to read and interpret their maps in order to move quickly and effectively on the battlefield. This chapter includes the definition and purpose of a map and describes map security, types, categories, and scales.*

- [Definition](#)
- [Purpose](#)
- [Care of Maps](#)
- [Map Categories](#)

### The Skills:

- [Maps](#)
- [Marginal Information and Symbols](#)

### Grids

- [Scale and Distance](#)

### Direction

- [Overlays](#)

### Aerial Photographs

- [Navigation](#)

### Equipment and

### Methods

- [Elevation and Relief](#)

- [Terrain Association](#)

- [Navigation in](#)

### Different Types of

### Terrain

- [Field Sketching](#)

- [Map Folding](#)

### Techniques

- [Units of Measure and](#)

### Conversion Factors

Check out the [Amazon Coupons](#) before you buy.

Copyright © 2001-2002 Jalic LLC. All Rights Reserved.

[Disclaimer](#) | [Privacy Policy](#) | [Contact Us](#)





[Orienteering Home](#)

## Marginal Information and Symbols

### The Sport:

- [Orienteering History](#)
- [Orienteering Overview](#)

### Overview

- [Course Setup](#)
- [Officials](#)
- [Start/Finish Areas](#)
- [Course Safety](#)
- [Control Point](#)

### Guidelines

- [Map Symbols](#)
- [Orienteering](#)

### Techniques

- [Civilian Orienteering](#)

*A map could be compared to any piece of equipment, in that before it is placed into operation the user must read the instructions. It is important that you, as a soldier, know how to read these instructions. The most logical place to begin is the marginal information and symbols, where useful information telling about the map is located and explained. All maps are not the same, so it becomes necessary every time a different map is used to examine the marginal information carefully.*

- [Marginal Information on a Military Map](#)
- [Topographic Map Symbols](#)
- [Colors used on a Map](#)

### The Skills:

- [Maps](#)
- [Marginal Information and Symbols](#)

### Grids

- [Scale and Distance](#)
- [Direction](#)
- [Overlays](#)

### Aerial Photographs

### Navigation

### Equipment and Methods

- [Elevation and Relief](#)
- [Terrain Association](#)
- [Navigation in](#)

### Different Types of Terrain

### Field Sketching

- [Map Folding](#)

### Techniques

- [Units of Measure and Conversion Factors](#)

Check out the [Amazon Coupons](#) before you buy.

Copyright © 2001-2002 Jalic LLC. All Rights Reserved.

[Disclaimer](#) | [Privacy Policy](#) | [Contact Us](#)







**Orienteering Home**

**The Sport:**

- **Orienteering History**
- **Orienteering Overview**
- **Course Setup**
- **Officials**
- **Start/Finish Areas**
- **Course Safety**
- **Control Point**
- **Guidelines**
- **Map Symbols**
- **Orienteering Techniques**
- **Civilian Orienteering**

**The Skills:**

- **Maps**
- **Marginal Information and Symbols**
- **Grids**
- **Scale and Distance**
- **Direction**
- **Overlays**
- **Aerial Photographs**
- **Navigation**
- **Equipment and Methods**
- **Elevation and Relief**
- **Terrain Association**
- **Navigation in Different Types of Terrain**
- **Field Sketching**
- **Map Folding**
- **Techniques**
- **Units of Measure and Conversion Factors**

## Grids

*This chapter covers how to determine and report positions on the ground in terms of their locations on a map. Knowing where you are (position fixing) and being able to communicate that knowledge is crucial to successful land navigation as well as to the effective employment of direct and indirect fire, tactical air support, and medical evacuation. It is essential for valid target acquisition; accurate reporting of NBC contamination and various danger areas; and obtaining emergency resupply. Few factors contribute as much to the survivability of troops and equipment and to the successful accomplishment of a mission as always knowing where you are. The chapter includes explanations of geographical coordinates, Universal Transverse Mercator grids, the military grid reference system, and the use of grid coordinates.*

*In a city, it is quite simple to find a location; the streets are named and the buildings have numbers. The only thing needed is the address. However, finding locations in undeveloped areas or in unfamiliar parts of the world can be a problem. To cope with this problem, a uniform and precise system of referencing has been developed.*

- **Geographic Coordinates**
- **Military Grids**
- **United States Military Grid Reference System**
- **Locate a Point Using Grid Coordinates**
- **Locate a Point Using the Military Grid Reference System**
- **Grid Reference Box**
- **Other Grid Systems**

Check out the **Amazon Coupons** before you buy.

Copyright © 2001-2002 Jalic LLC. All Rights Reserved.

**Disclaimer | Privacy Policy | Contact Us**





[Orienteering Home](#)

## Scale and Distance

### The Sport:

- [Orienteering History](#)
- [Orienteering](#)

### Overview

- [Course Setup](#)
- [Officials](#)
- [Start/Finish Areas](#)
- [Course Safety](#)
- [Control Point](#)

### Guidelines

- [Map Symbols](#)
- [Orienteering](#)

### Techniques

- [Civilian Orienteering](#)

*A map is a scaled graphic representation of a portion of the earth's surface. The scale of the map permits the user to convert distance on the map to distance on the ground or vice versa. The ability to determine distance on a map, as well as on the earth's surface, is an important factor in planning and executing military missions.*

- [Representative Fraction](#)
- [Graphic \(Bar\) Scales](#)
- [Other Methods](#)

### The Skills:

- [Maps](#)
- [Marginal Information and Symbols](#)

- [Grids](#)
- [Scale and Distance](#)
- [Direction](#)
- [Overlays](#)

- [Aerial Photographs](#)
- [Navigation](#)

### Equipment and Methods

- [Elevation and Relief](#)
- [Terrain Association](#)
- [Navigation in](#)

### Different Types of Terrain

- [Field Sketching](#)
- [Map Folding](#)

### Techniques

- [Units of Measure and Conversion Factors](#)

Check out the [Amazon Coupons](#) before you buy.

Copyright © 2001-2002 Jalic LLC. All Rights Reserved.

[Disclaimer](#) | [Privacy Policy](#) | [Contact Us](#)





[Orienteering Home](#)

The Sport:

- [Orienteering History](#)
- [Orienteering Overview](#)

Overview

- [Course Setup](#)
- [Officials](#)
- [Start/Finish Areas](#)
- [Course Safety](#)
- [Control Point](#)

Guidelines

- [Map Symbols](#)
- [Orienteering Techniques](#)

Techniques

- [Civilian Orienteering](#)

The Skills:

- [Maps and Symbols](#)
- [Marginal Information and Symbols](#)
- [Grids](#)
- [Scale and Distance](#)
- [Direction](#)
- [Overlays](#)
- [Aerial Photographs](#)
- [Navigation](#)

Equipment and Methods

- [Elevation and Relief](#)
- [Terrain Association](#)
- [Navigation in Different Types of Terrain](#)

Different Types of Terrain

- [Field Sketching](#)
- [Map Folding](#)

Techniques

- [Units of Measure and Conversion Factors](#)

## Direction

*Being in the right place at the prescribed time is necessary to successfully accomplish military missions. Direction plays an important role in a soldier's everyday life. It can be expressed as right, left, straight ahead, and so forth; but then the question arises, "To the right of what?" This chapter defines the word azimuth and the three different norths. It explains in detail how to determine the grid and the magnetic azimuths with the use of the protractor and the compass. It explains the use of some field-expedient methods to find directions, the declination diagram, and the conversion of azimuths from grid to magnetic and vice versa. It also includes some advanced aspects of map reading, such as intersection, resection, modified resection, and polar plots.*

- [Methods of Expressing Direction](#)
- [Base Lines](#)
- [Azimuths](#)
- [Grid Azimuths](#)
- [Protractors](#)
- [Declination](#)
- [Intersection](#)
- [Resection](#)
- [Polar Coordinates](#)

Check out the [Amazon Coupons](#) before you buy.

Copyright © 2001-2002 Jalic LLC. All Rights Reserved.

[Disclaimer](#) | [Privacy Policy](#) | [Contact Us](#)







[Orienteering Home](#)

## Overlays

### The Sport:

- [Orienteering History](#)
- [Orienteering](#)

### Overview

- [Course Setup](#)
- [Officials](#)
- [Start/Finish Areas](#)
- [Course Safety](#)
- [Control Point](#)

### Guidelines

- [Map Symbols](#)
- [Orienteering](#)

### Techniques

- [Civilian Orienteering](#)

*An overlay is a clear sheet of plastic or semi-transparent paper. It is used to display supplemental map and tactical information related to military operations. It is often used as a supplement to orders given in the field. Information is plotted on the overlay at the same scale as on the map, aerial photograph, or other graphic being used. When the overlay is placed over the graphic, the details plotted on the overlay are shown in their true position.*

- [Map Overlays](#)
- [Aerial Photograph Overlays](#)

### The Skills:

- [Maps](#)
- [Marginal Information and Symbols](#)

### Grids

- [Scale and Distance](#)
- [Direction](#)
- [Overlays](#)

### Aerial Photographs

### Navigation

### Equipment and

### Methods

- [Elevation and Relief](#)
- [Terrain Association](#)
- [Navigation in](#)

### Different Types of Terrain

### Field Sketching

### Map Folding

### Techniques

- [Units of Measure and Conversion Factors](#)

Check out the [Amazon Coupons](#) before you buy.

Copyright © 2001-2002 Jalic LLC. All Rights Reserved.

[Disclaimer](#) | [Privacy Policy](#) | [Contact Us](#)





**Orienteering Home**

## Aerial Photographs

**The Sport:**

*An aerial photograph is any photograph taken from an airborne vehicle (aircraft, drones, balloons, satellites, and so forth). The aerial photograph has many uses in military operations; however, for the purpose of this manual, it will be considered primarily as a map supplement or map substitute.*

• **Orienteering History**

• **Orienteering**

**Overview**

• **Course Setup**

• **Officials**

• **Start/Finish Areas**

• **Course Safety**

• **Control Point**

**Guidelines**

• **Map Symbols**

• **Orienteering**

**Techniques**

• **Civilian Orienteering**

- **Comparison with Maps**
- **Types of Aerial Photographs**
- **Types of Film**
- **Scale Determination**
- **Indexing**
- **Orienting of Photographs**
- **Point Designation Grid**
- **Identification of Photograph Features**
- **Stereovision**

**The Skills:**

• **Maps**

• **Marginal Information**

**and Symbols**

• **Grids**

• **Scale and Distance**

• **Direction**

• **Overlays**

• **Aerial Photographs**

• **Navigation**

**Equipment and**

**Methods**

• **Elevation and Relief**

• **Terrain Association**

• **Navigation in**

**Different Types of**

**Terrain**

• **Field Sketching**

• **Map Folding**

**Techniques**

• **Units of Measure and**

**Conversion Factors**

Check out the **Amazon Coupons** before you buy.

Copyright © 2001-2002 Jalic LLC. All Rights Reserved.

**Disclaimer | Privacy Policy | Contact Us**





[Orienteering Home](#)

## Navigation Equipment and Methods

### The Sport:

- [Orienteering History](#)
- [Orienteering Overview](#)

### Overview

- [Course Setup](#)
- [Officials](#)
- [Start/Finish Areas](#)
- [Course Safety](#)
- [Control Point](#)

### Guidelines

- [Map Symbols](#)
- [Orienteering Techniques](#)

### Techniques

- [Civilian Orienteering](#)

*Compasses are the primary navigation tools to use when moving in an outdoor world where there is no other way to find directions. Soldiers should be thoroughly familiar with the compass and its uses. Part One of this manual discussed the techniques of map reading. To complement these techniques, a mastery of field movement techniques is essential. This chapter describes the lensatic compass and its uses, and some of the field expedient methods used to find directions when compasses are not available.*

- [Types of Compasses](#)
- [Compass Handling](#)
- [Using a Compass](#)
- [Field-Expedient Methods](#)
- [Global Positioning System](#)

### The Skills:

- [Maps](#)
- [Marginal Information and Symbols](#)

- [Grids](#)
- [Scale and Distance](#)
- [Direction](#)

- [Overlays](#)
- [Aerial Photographs](#)
- [Navigation](#)

### Equipment and Methods

- [Elevation and Relief](#)
- [Terrain Association](#)
- [Navigation in Different Types of Terrain](#)

### Different Types of Terrain

- [Field Sketching](#)
- [Map Folding](#)

### Techniques

- [Units of Measure and Conversion Factors](#)

Check out the [Amazon Coupons](#) before you buy.

Copyright © 2001-2002 Jalic LLC. All Rights Reserved.

[Disclaimer](#) | [Privacy Policy](#) | [Contact Us](#)







[Orienteering Home](#)

## Elevation and Relief

### The Sport:

- [Orienteering History](#)
- [Orienteering Overview](#)

### Overview

- [Course Setup](#)
- [Officials](#)
- [Start/Finish Areas](#)
- [Course Safety](#)
- [Control Point](#)

### Guidelines

- [Map Symbols](#)
- [Orienteering](#)

### Techniques

- [Civilian Orienteering](#)

### The Skills:

- [Maps](#)
- [Marginal Information and Symbols](#)
- [Grids](#)
- [Scale and Distance](#)
- [Direction](#)
- [Overlays](#)
- [Aerial Photographs](#)
- [Navigation](#)

### Equipment and Methods

- [Elevation and Relief](#)
- [Terrain Association](#)
- [Navigation in](#)

### Different Types of Terrain

- [Field Sketching](#)
- [Map Folding](#)

### Techniques

- [Units of Measure and Conversion Factors](#)

*The elevation of points on the ground and the relief of an area affect the movement, positioning, and, in some cases, effectiveness of military units. Soldiers must know how to determine locations of points on a map, measure distances and azimuths, and identify symbols on a map. They must also be able to determine the elevation and relief of areas on standard military maps. To do this, they must first understand how the mapmaker indicated the elevation and relief on the map.*

- [Definitions](#)
- [Methods of Depicting Relief](#)
- [Contour Intervals](#)
- [Types of Slopes](#)
- [Percentage of Slope](#)
- [Terrain Features](#)
- [Interpretation of Terrain Features](#)
- [Profiles](#)

Check out the [Amazon Coupons](#) before you buy.

Copyright © 2001-2002 Jalic LLC. All Rights Reserved.

[Disclaimer](#) | [Privacy Policy](#) | [Contact Us](#)





[Orienteering Home](#)

## Terrain Association

### The Sport:

- [Orienteering History](#)
- [Orienteering](#)

### Overview

- [Course Setup](#)
- [Officials](#)
- [Start/Finish Areas](#)
- [Course Safety](#)
- [Control Point](#)

### Guidelines

- [Map Symbols](#)
- [Orienteering](#)

### Techniques

- [Civilian Orienteering](#)

### The Skills:

- [Maps](#)
- [Marginal Information and Symbols](#)
- [Grids](#)
- [Scale and Distance](#)
- [Direction](#)
- [Overlays](#)
- [Aerial Photographs](#)
- [Navigation](#)

### Equipment and

### Methods

- [Elevation and Relief](#)
- [Terrain Association](#)
- [Navigation in](#)

### Different Types of Terrain

- [Field Sketching](#)
- [Map Folding](#)

### Techniques

- [Units of Measure and Conversion Factors](#)

*Failure to make use of the vast amounts of information presented by the map and available to the eye on the ground reduces the chances for success in land navigation. The soldier who has repeatedly practiced the skills of identifying and discriminating among the many types of terrain and other features knows how these features are mapped. He can begin to visualize the shape of the land by studying the map, estimate distances, and perform quick resection from the many landmarks he sees is the one who will be at the right place to help defeat the enemy on the battlefield. This chapter tells how to orient a map with and without a compass, how to find locations on a map as well as on the ground, how to study the terrain, and how to move on the ground using terrain association and dead reckoning.*

- [Orienting the Map](#)
- [Locations](#)
- [Terrain Association Usage](#)
- [Movement and Route Selection](#)
- [Navigation Methods](#)
- [Night Navigation](#)

Check out the [Amazon Coupons](#) before you buy.

Copyright © 2001-2002 Jalic LLC. All Rights Reserved.

[Disclaimer](#) | [Privacy Policy](#) | [Contact Us](#)





[Orienteering Home](#)

## Navigation in Different Types of Terrain

The Sport:

- [Orienteering History](#)
- [Orienteering](#)

Overview

- [Course Setup](#)
- [Officials](#)
- [Start/Finish Areas](#)
- [Course Safety](#)
- [Control Point](#)

Guidelines

- [Map Symbols](#)
- [Orienteering](#)

Techniques

- [Civilian Orienteering](#)

*The information, concepts, and skills already presented will help you to navigate anywhere in the world; however, there are some special considerations and helpful hints that may assist you in various special environments. The following information is not doctrine.*

- [Desert Terrain](#)
- [Mountain Terrain](#)
- [Jungle Terrain](#)
- [Arctic Terrain](#)

The Skills:

- [Maps](#)
- [Marginal Information and Symbols](#)

- [Grids](#)
- [Scale and Distance](#)
- [Direction](#)
- [Overlays](#)
- [Aerial Photographs](#)
- [Navigation](#)

Equipment and

Methods

- [Elevation and Relief](#)
- [Terrain Association](#)
- [Navigation in](#)

Different Types of Terrain

- [Field Sketching](#)
- [Map Folding](#)

Techniques

- [Units of Measure and Conversion Factors](#)

Check out the [Amazon Coupons](#) before you buy.

Copyright © 2001-2002 Jalic LLC. All Rights Reserved.

[Disclaimer](#) | [Privacy Policy](#) | [Contact Us](#)







# Orienteeing

## Orienteeing Home

### The Sport:

- Orienteeing History
- Orienteeing

### Overview

- Course Setup
- Officials
- Start/Finish Areas
- Course Safety
- Control Point

### Guidelines

- Map Symbols
- Orienteeing

### Techniques

- Civilian Orienteeing

### The Skills:

- Maps
- Marginal Information and Symbols

- Grids
- Scale and Distance
- Direction
- Overlays

- Aerial Photographs
- Navigation

### Equipment and

### Methods

- Elevation and Relief
- Terrain Association
- Navigation in

### Different Types of Terrain

- Field Sketching
- Map Folding

### Techniques

- Units of Measure and Conversion Factors

## Field Sketching

*A sketch is a free-hand drawing of a map or picture of an area or route of travel. It shows enough detail and has enough accuracy to satisfy special tactical or administrative requirements.*

### A-1. PURPOSE

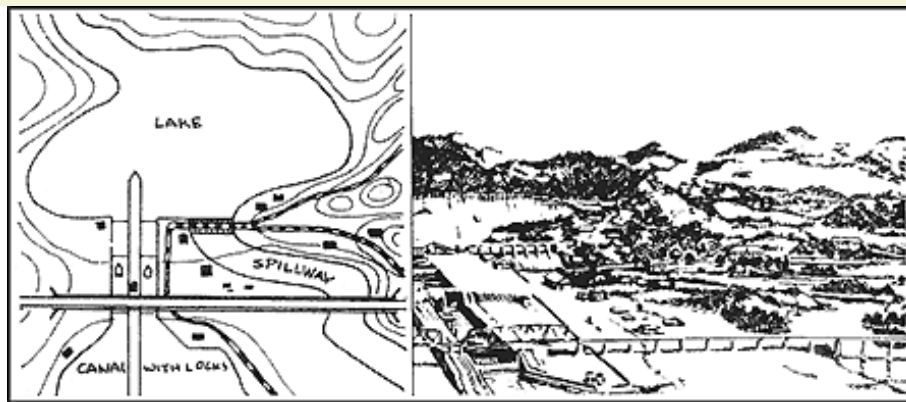
Sketches are useful when maps are not available or the existing maps are not adequate, or to illustrate a reconnaissance or patrol report. Sketches may vary from hasty to complete and detailed, depending upon their purpose and the degree of accuracy required. For example, a sketch of a large minefield will require more accuracy than a hasty sketch of a small unit's defensive position.

### A-2. MILITARY SKETCHES

The scale of a sketch is determined by the object in view and the amount of detail required to be shown. The sketch of a defensive position for a platoon or company normally calls for a sketch of larger scale than a sketch for the same purpose for a division. Military sketches also include road and area sketches.

a. **Field Sketches.** A field sketch (Figure A-1) must show the north arrow, scale, legend, and the following features:

- Power lines.
- Rivers.
- Main roads.
- Towns and villages.
- Forests.
- Rail lines.
- Major terrain features.



**Figure A-1. Sketch map.**

b. **Road Sketches.** These sketches show the natural and military features on and in the immediate vicinity of the road. In general, the width of terrain sketches will not exceed 365 meters on each side of the road. Road sketches may be used to illustrate a road when the existing map does not show sufficient detail.

c. **Area Sketches.** These sketches include those of positions, OPs, or particular places.

(1) **Position Sketch.** A position sketch is one of a military position, campsite, or other area of ground. To effectively complete a position sketch, the sketcher must have access to all parts of the area being sketched.

(2) **Observation Post Sketch.** An OP sketch shows the military features of ground along a friendly OP line as far toward the enemy position as possible.

(3) **Place Sketch.** A place sketch is one of an area made by a sketcher from a single point of observation. Such a sketch may cover ground in front of an OP line, or it may serve to extend a position or road sketch toward the enemy.

Check out the **Amazon Coupons** before you buy.

Copyright © 2001-2002 Jalic LLC. All Rights Reserved.

**Disclaimer | Privacy Policy | Contact Us**



[Orienteering Home](#)

**The Sport:**

- Orienteering History
- Orienteering

**Overview**

- Course Setup
- Officials
- Start/Finish Areas
- Course Safety
- Control Point

**Guidelines**

- Map Symbols
- Orienteering

**Techniques**

- Civilian Orienteering

**The Skills:**

- Maps
- Marginal Information and Symbols
- Grids
- Scale and Distance
- Direction
- Overlays
- Aerial Photographs
- Navigation

**Equipment and Methods**

- Elevation and Relief
- Terrain Association
- Navigation in

**Different Types of Terrain**

- Field Sketching
- Map Folding

**Techniques**

- Units of Measure and Conversion Factors

## Map Folding Techniques

*One of the first considerations in the care of maps is its proper folding.*

### B-1. FOLDING METHODS

Figures B-1 and B-2 show ways of folding maps to make them small enough to be carried easily and still be available for use without having to unfold them entirely.

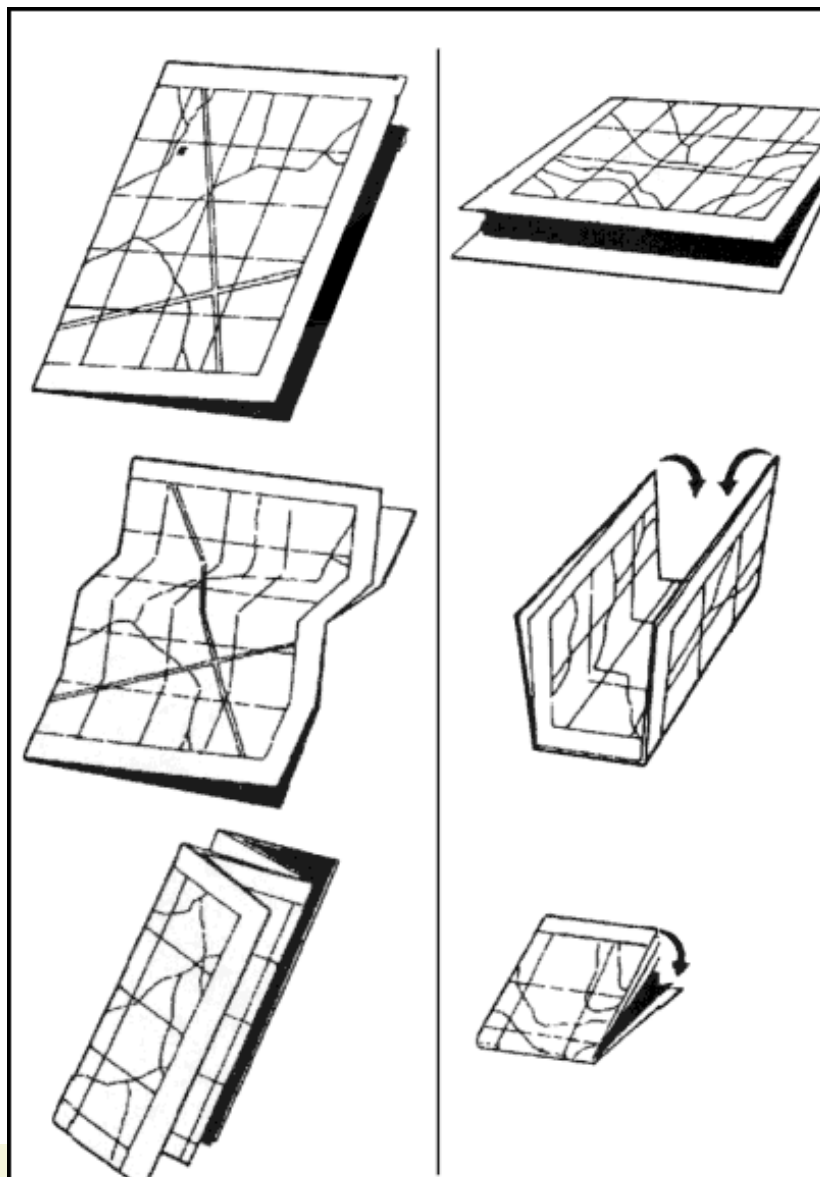




Figure B-1. Two methods of folding a map.

## B-2. PROTECTION METHOD

After a map has been folded, it should be pasted in a folder for protection. Apply adhesive to the back of the segments corresponding to A, F, L, and Q (Figure B-2).

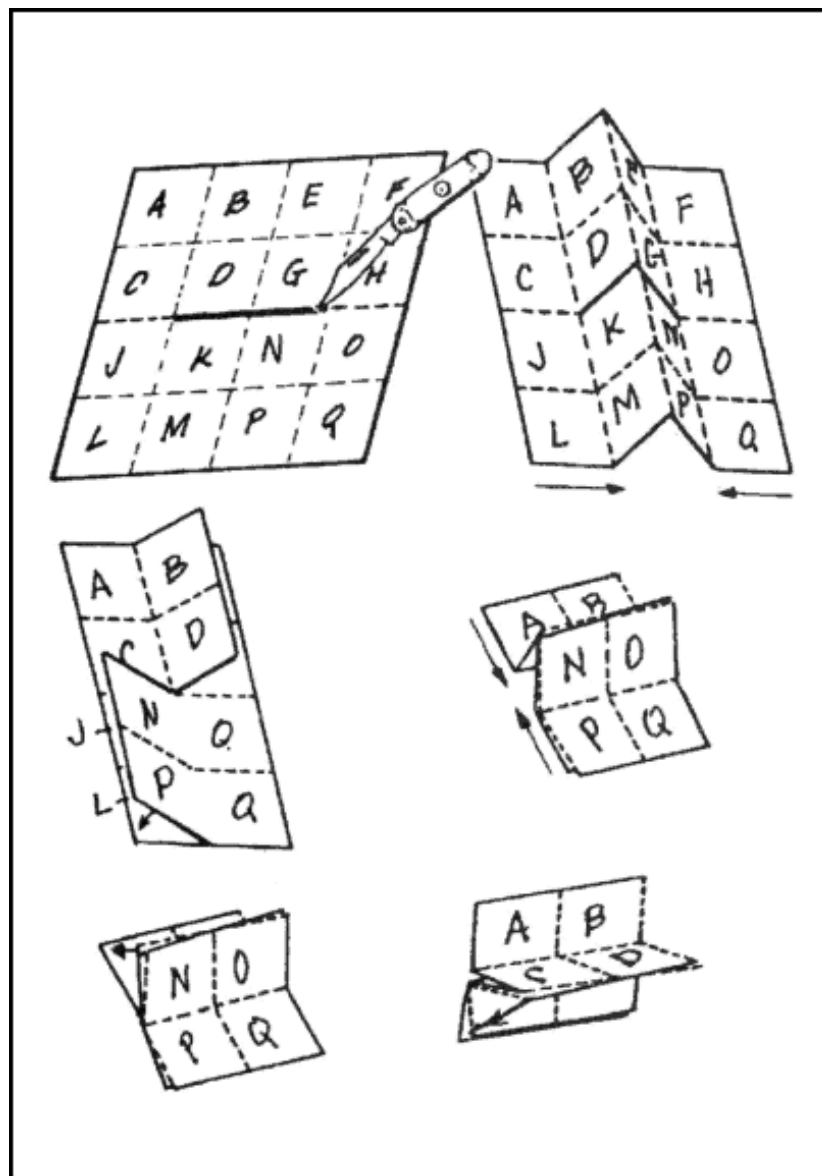


Figure B-2. How to slit and fold a map for special use.

## B-3. PRACTICE CUT

It is suggested that before attempting to cut and fold a map in the manner illustrated in Figure B-2, make a practice cut and fold with a piece of paper.

Check out the **Amazon Coupons** before you buy.

Copyright © 2001-2002 Jalic LLC. All Rights Reserved.

**[Disclaimer](#) | [Privacy Policy](#) | [Contact Us](#)**





[Orienteering Home](#)

## Units of Measure and Conversion Factors

**The Sport:**

*This appendix provides conversion tables for units of measure and conversion factors that are used in military operations.*

- [Orienteering History](#)
- [Orienteering](#)

**Overview**

- [Course Setup](#)
- [Officials](#)
- [Start/Finish Areas](#)
- [Course Safety](#)
- [Control Point](#)

**Guidelines**

- [Map Symbols](#)
- [Orienteering](#)

**Techniques**

- [Civilian Orienteering](#)

**The Skills:**

- [Maps](#)
- [Marginal Information and Symbols](#)
- [Grids](#)
- [Scale and Distance](#)
- [Direction](#)
- [Overlays](#)
- [Aerial Photographs](#)
- [Navigation](#)

**Equipment and**

**Methods**

- [Elevation and Relief](#)
- [Terrain Association](#)
- [Navigation in](#)

**Different Types of Terrain**

- [Field Sketching](#)
- [Map Folding](#)

**Techniques**

- [Units of Measure and Conversion Factors](#)

12 inches	=	1 foot
36 inches	=	1 yard
3 feet	=	1 yard
1,760 yards	=	1 mile statute
2,026.8 yards	=	1 mile nautical
5,280 feet	=	1 mile statute
6,080.4 feet	=	1 mile nautical
63,360 inches	=	1 mile statute
72,963 inches	=	1 mile nautical

**Table C-1. English system of linear measure.**

1 millimeter	=	centimeter	=	0.0393 inches
10 millimeters	=	centimeter	=	0.3937 inches
10 centimeters	=	decimeter	=	3.937 inches
10 decimeters	=	meter	=	39.37 inches
10 meters	=	decameter	=	32.81 feet
10 decameters	=	hectometer	=	328.1 feet



10 hectometers	=	kilometer	=	0.62 mile
10 kilometers	=	1.0 myriameter	=	6.21 miles

**Table C-2. Metric system of linear measure.**

1 mil	=	1/6400 circle	=	0.05625°	=	0.0625 grad
1 grad	=	1/400 circle	=	16.0 mils	=	0°54' = 0.9°
1 degree	=	1/360 circle	=	about 17.8 mils	=	about 1.1 grad

**Table C-3. Equivalent units of angular measure.**

ONE	INCHES	FEET	YARDS	STATUTE MILES	NAUTICLE MILES	mm
Inch	1	0.0833	0.0277	-	-	25.40
Foot	12	1	0.333	-	-	304.8
Yard	36	3	1	0.00056	-	914.4
Statute Mile	63,360	5,280	1,760	1	0.8684	-
Nautical Mile	72,963	6,080	2,026	1.1516	1	-
Millimeter	0.0394	0.0033	0.0011	-	-	1
Centimeter	0.3937	0.0328	0.0109	-	-	10
Decimeter	3.937	0.328	0.1093	-	-	100
Meter	39.37	3.2808	1.0936	0.0006	0.0005	1,000
Decameter	393.7	32.81	10.94	0.0062	0.0054	10,000
Hectometer	3,937	328.1	109.4	0.0621	0.0539	100,000
Kilometer	39,370	3,281	1,094	0.6214	0.5396	1,000,000
Myriameter	393,700	32,808	10,936	6.2137	5.3959	10,000,000

ONE	cm	dm	M	dkm	hm	km	mym
Inch	2.540	0.2540	0.0254	0.0025	0.0003	-	-
Foot	30.48	3.048	0.3048	0.0305	0.0030	0.0003	-
Yard	91.44	9.144	0.9144	0.0914	0.0091	0.0009	-
Statute Mile	160,930	16,093	1,609	160.9	16.09	1.6093	0.1609
Nautical Mile	185,325	18,532	1,853	185.3	18.53	1.8532	0.1853
Millimeter	0.1	0.01	0.001	0.0001	-	-	-

Centimeter	1	0.1	0.01	0.001	0.0001	-	-
Decimeter	10	1	0.1	0.01	0.001	0.0001	-
Meter	100	1	1	0.1	0.01	0.001	0.0001
Decameter	1,000	10	10	1	0.1	0.01	0.001
Hectometer	10,000	100	100	10	1	0.1	0.01
Kilometer	100,000	1,000	1,000	100	10	1	0.1
Myriameter	1,000,000	10,000	10,000	1000	100	10	1

**Table C-4. Conversion factors.**

### Example I

Problem: Reduce 76 centimeters to (?) inches.  
 $76 \text{ cm} \times 0.3937 = 29 \text{ inches}$

Answer: There are 29 inches in 76 centimeters.

### Example II

Problem: How many feet are there in 2.74 meters?

$$\frac{2.74}{.3048} = 9 \text{ feet}$$

Answer: There are approximately 9 feet in 2.74 meters.

SCALE	1 INCH EQUALS	1 CENTIMETER EQUALS
1:5,000	416.67 feet 127.00 meters	164.00 feet 50.00 meters
1:10,000	833.33 feet 254.00 meters	328.10 feet 100.00 meters
1:12,500	1,041.66 feet 317.00 meters	410.10 feet 125.00 meters
1:20,000	1,666.70 feet 508.00 meters	656.20 feet 200.00 meters
1:25,000	2,083.30 feet 635.00 meters	820.20 feet 250.00 meters

1:50,000	4,166.70 feet 1,270.00 meters	1,640.40 feet 500.00 meters
1:63,360	5,280.00 feet 1,609.30 meters	2,078.70 feet 633.60 meters
1:100,000	8,333.30 feet 2,540.00 meters	3,280.80 feet 1,000.00 meters
1:250,000	20,833.00 feet 6,350.00 meters	8,202.00 feet 2,500.00 meters
1:500,000	41,667.00 feet 12,700.00 meters	16,404.00 feet 5,000.00 meters

**Table C-5. Ground distance at map scale.**

Check out the **Amazon Coupons** before you buy.

Copyright © 2001-2002 Jalic LLC. All Rights Reserved.

**Disclaimer | Privacy Policy | Contact Us**

# Wilderness Survival

**Take Our Survival Quiz, Click Here!**

**Wilderness Survival Home**

## Wilderness Survival

1. Introduction
2. Psychology of Survival
3. Survival Kits & Planning
4. Survival Medicine
5. Shelters
6. Water Procurement
7. Firecraft
8. Food Procurement
9. Survival Use of Plants
10. Poisonous Plants
11. Dangerous Animals
12. Weapons, Tools, and Equipment
13. Desert Survival
14. Tropical Survival
15. Cold Weather Survival
16. Sea Survival
17. Water Crossings
18. Wilderness Navigation
19. Signaling Techniques
20. Hostile Areas
21. Camouflage
22. Contact With People
23. Survival in Man-Made Hazards

## Survival Reference

- A. Survival Kits
- B. Edible and Medicinal Plants
- C. Poisonous Plants
- D. Dangerous Insects and Arachnids
- E. Poisonous Snakes and Lizards
- F. Dangerous Fish and Mollusks
- G. Clouds: Foretellers of Weather
- H. Survive Outdoors

## Marketplace

Tents

**GPS & Navigation**

**First Aid & Safety**

**Knives & Tools**

**Wilderness Survival Books**

**Hiking Boots**

**Backpacks**

**Lights & Laterns**

**Survival  
Top  
Sites**

## **FIELD-EXPEDIENT DIRECTION FINDING**



*In a survival situation, you will be extremely fortunate if you happen to have a map and compass. If you do have these two pieces of equipment, you will most likely be able to move toward help. If you are not proficient in using a map and compass, you must take the steps to gain this skill.*

*There are several methods by which you can determine direction by using the sun and the stars. These methods, however, will give you only a general direction. You can come up with a more nearly true direction if you know the terrain of the territory or country.*

*You must learn all you can about the terrain of the country or territory to which you or your unit may be sent, especially any prominent features or landmarks. This knowledge of the terrain together with using the **methods** explained below will let you come up with fairly true directions to help you navigate.*

### **USING THE SUN AND SHADOWS**

The earth's relationship to the sun can help you to determine direction on earth. The sun always rises in the east and sets in the west, but not exactly due east or due west. There is also some seasonal variation. In the northern hemisphere, the sun will be due south when at its highest point in the sky, or when an object casts no appreciable shadow. In the southern hemisphere, this same noonday sun will mark due north. In the northern hemisphere, shadows will move clockwise. Shadows will move counterclockwise in the southern hemisphere. With practice, you can use shadows to determine both direction and time of day. The shadow methods used for direction finding are the shadow-tip and watch methods.

#### **Shadow-Tip Methods**

In the first shadow-tip method, find a straight stick 1 meter long, and a level spot free of brush on which the stick will cast a definite shadow. This method is simple and accurate and consists of four steps:

- *Step 1.* Place the stick or branch into the ground at a level spot where it will cast a distinctive shadow. Mark the shadow's tip with a stone, twig, or other means. This first shadow mark is always west--**everywhere** on earth.
- *Step 2.* Wait 10 to 15 minutes until the shadow tip moves a few centimeters. Mark the shadow tip's new position in the same way as the first.
- *Step 3.* Draw a straight line through the two marks to obtain an approximate east-west line.
- *Step 4.* Stand with the first mark (west) to your left and the second mark to your right--you are now facing north. This fact is true **everywhere** on earth.

An alternate method is more accurate but requires more time. Set up your shadow stick and mark the first shadow in the morning. Use a piece of string to draw a clean arc through this mark and around the stick. At midday, the shadow will shrink and disappear. In the afternoon, it will lengthen again and at the point where it touches the arc, make a second mark. Draw a line through the two marks to get an accurate east-west line (see [Figure 18-1](#)).

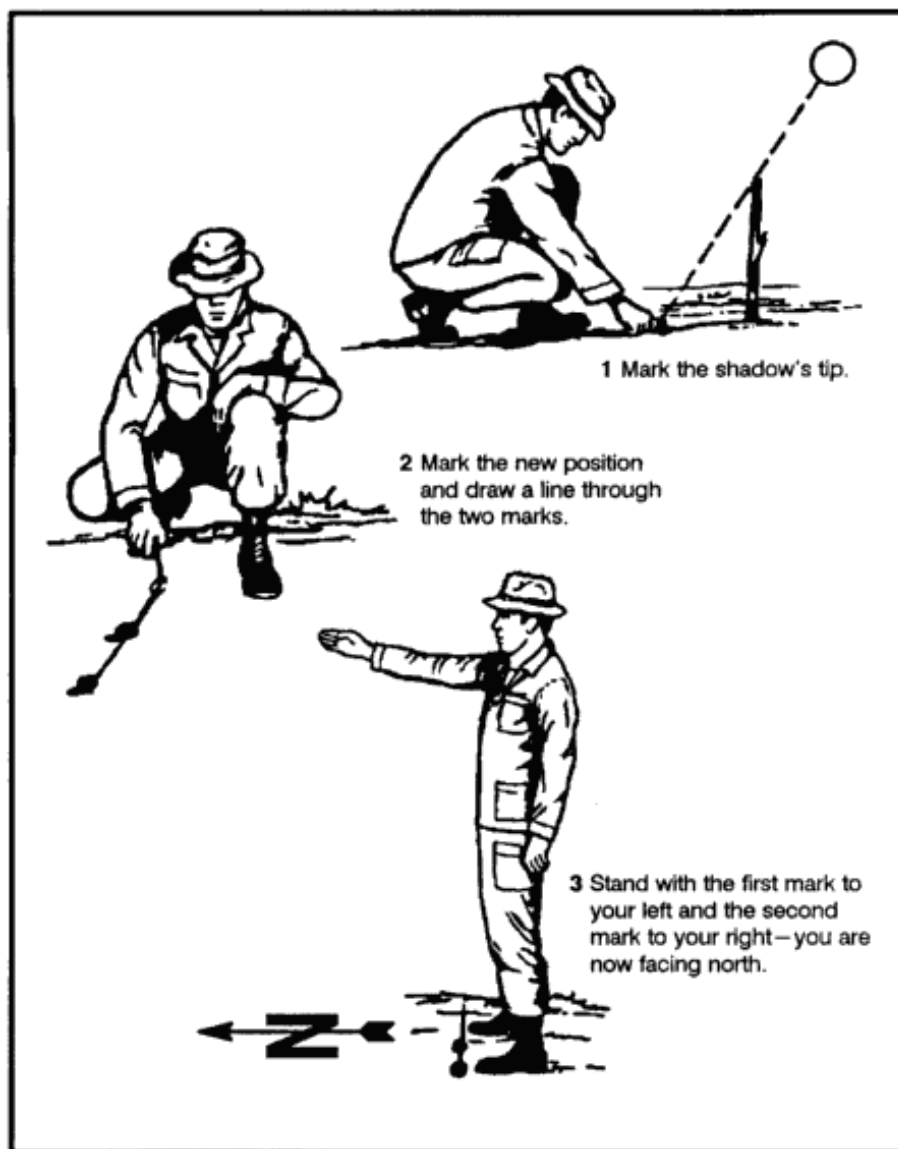


Figure 18-1. Shadow-tip method.



## The Watch Method

You can also determine direction using a common or analog watch--one that has hands. The direction will be accurate if you are using true local time, without any changes for daylight savings time. Remember, the further you are from the equator, the more accurate this method will be. If you only have a digital watch, you can overcome this obstacle. Quickly draw a watch on a circle of paper with the correct time on it and use it to determine your direction at that time.

In the northern hemisphere, hold the watch horizontal and point the hour hand at the sun. Bisect the angle between the hour hand and the 12 o'clock mark to get the north-south line (Figure 18-2). If there is any doubt as to which end of the line is north, remember that the sun rises in the east, sets in the west, and is due south at noon. The sun is in the east before noon and in the west after noon.

*Note: If your watch is set on daylight savings time, use the midway point between the hour hand and 1 o'clock to determine the north-south line.*

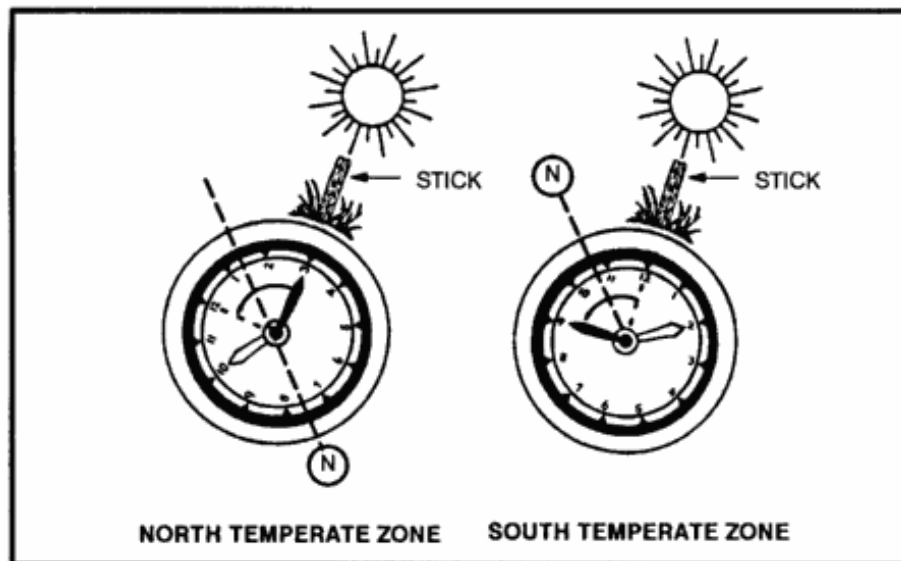


Figure 18-2. Watch method.

In the southern hemisphere, point the watch's 12 o'clock mark toward the sun and a midpoint halfway between 12 and the hour hand will give you the north-south line (Figure 18-2).

## USING THE MOON

Because the moon has no light of its own, we can only see it when it reflects the sun's light. As it orbits the earth on its 28-day circuit, the shape of the reflected light varies according to its position. We say there is a new moon or no moon when it is on the opposite side of the earth from the sun. Then, as it moves away from the earth's shadow, it begins to reflect light from its right side and waxes to become a full moon before waning, or losing shape, to appear as a sliver on the left side. You can use this information to identify direction.

If the moon rises before the sun has set, the illuminated side will be the west. If the moon rises after midnight, the illuminated side will be the east. This obvious discovery provides us with a rough east-west reference during the night.

## USING THE STARS

Your location in the Northern or Southern Hemisphere determines which constellation you use to determine your north or south direction.

### The Northern Sky

The main constellations to learn are the Ursa Major, also known as the Big Dipper or the Plow, and Cassiopeia (Figure 18-3). Neither of these constellations ever sets. They are always visible on a clear night. Use them to locate Polaris, also known as the polestar or the North

Star. The North Star forms part of the Little Dipper handle and can be confused with the Big Dipper. Prevent confusion by using both the Big Dipper and Cassiopeia together. The Big Dipper and Cassiopeia are always directly opposite each other and rotate counterclockwise around Polaris, with Polaris in the center. The Big Dipper is a seven star constellation in the shape of a dipper. The two stars forming the outer lip of this dipper are the "pointer stars" because they point to the North Star. Mentally draw a line from the outer bottom star to the outer top star of the Big Dipper's bucket. Extend this line about five times the distance between the pointer stars. You will find the North Star along this line.

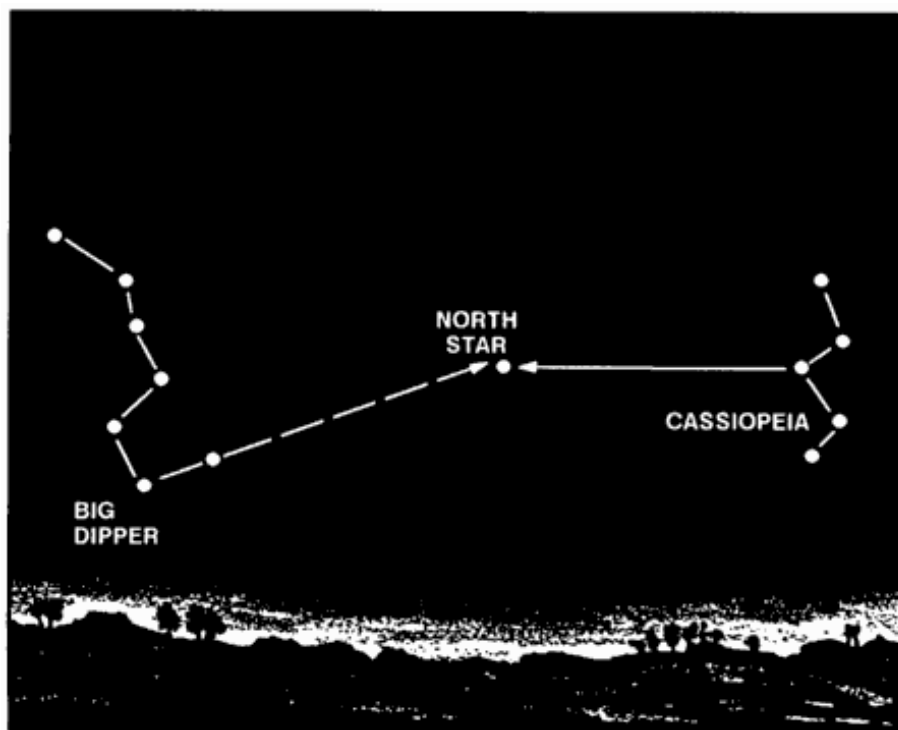


Figure 18-3. The Big Dipper and Cassiopeia.

Cassiopeia has five stars that form a shape like a "W" on its side. The North Star is straight out from Cassiopeia's center star.

After locating the North Star, locate the North Pole or true north by drawing an imaginary line directly to the earth.

### The Southern Sky

Because there is no star bright enough to be easily recognized near the south celestial pole, a constellation known as the Southern Cross is used as a signpost to the South (Figure 18-4). The Southern Cross or Crux has five stars. Its four brightest stars form a cross that tilts to one side. The two stars that make up the cross's long axis are the pointer stars. To determine south, imagine a distance five times the distance between These stars and the point where this imaginary line ends is in the general direction of south. Look down to the horizon from this imaginary point and select a landmark to steer by. In a static survival situation, you can fix this location in daylight if you drive stakes in the ground at night to point the way.

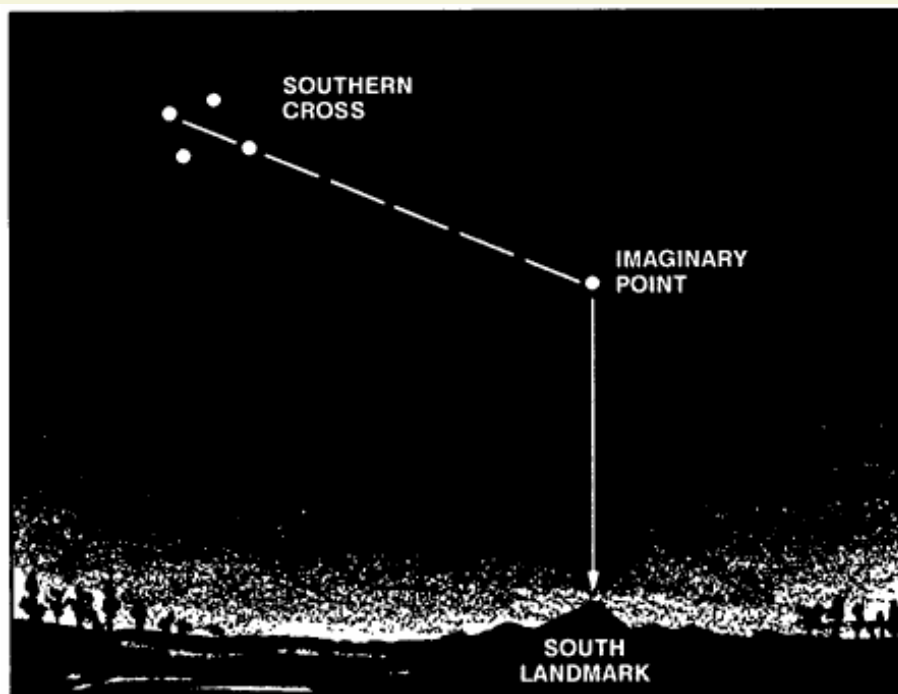


Figure 18-4. Southern Cross.

## MAKING IMPROVISED COMPASSES

You can construct improvised compasses using a piece of ferrous metal that can be needle shaped or a flat double-edged razor blade and a piece of nonmetallic string or long hair from which to suspend it. You can magnetize or polarize the metal by slowly stroking it in one direction on a piece of silk or carefully through your hair using deliberate strokes. You can also polarize metal by stroking it repeatedly at one end with a magnet. Always rub in one direction only. If you have a battery and some electric wire, you can polarize the metal electrically. The wire should be insulated. If not insulated, wrap the metal object in a single, thin strip of paper to prevent contact. The battery must be a minimum of 2 volts. Form a coil with the electric wire and touch its ends to the battery's terminals. Repeatedly insert one end of the metal object in and out of the coil. The needle will become an electromagnet. When suspended from a piece of nonmetallic string, or floated on a small piece of wood in water, it will align itself with a north-south line.

You can construct a more elaborate improvised compass using a sewing needle or thin metallic object, a nonmetallic container (for example, a plastic dip container), its lid with the center cut out and waterproofed, and the silver tip from a pen. To construct this compass, take an ordinary sewing needle and break in half. One half will form your direction pointer and the other will act as the pivot point. Push the portion used as the pivot point through the bottom center of your container; this portion should be flush on the bottom and not interfere with the lid. Attach the center of the other portion (the pointer) of the needle on the pen's silver tip using glue, tree sap, or melted plastic. Magnetize one end of the pointer and rest it on the pivot point.

## OTHER MEANS OF DETERMINING DIRECTION

The old saying about using moss on a tree to indicate north is not accurate because moss grows completely around some trees. Actually, growth is more lush on the side of the tree facing the south in the Northern Hemisphere and vice versa in the Southern Hemisphere. If there are several felled trees around for comparison, look at the stumps. Growth is more vigorous on the side toward the equator and the tree growth rings will be more widely spaced. On the other hand, the tree growth rings will be closer together on the side toward the poles.

Wind direction may be helpful in some instances where there are prevailing directions and you know what they are.

Recognizing the differences between vegetation and moisture patterns on north- and south-facing slopes can aid in determining direction. In the northern hemisphere, north-facing slopes receive less sun than south-facing slopes and are therefore cooler and damper. In the summer, north-facing slopes retain patches of snow. In the winter, the trees and open areas on south-facing slopes are the first to lose their snow, and ground snowpack is shallower.

## Bushmaster Survival Knife



This sharp multi-functional knife has a 10" blade and 5 1/4" grip. Between the heavy nylon sheath pouches and the hollow knife handle, you have room for a compass, G.I. can opener, sharpening stone, animal snare, snake bite kit, flashlight, matches, surgical blade, sewing needles, Band-Aids, a magnifier, and fishing hooks, line, and sinkers -- **all of which is included**. This is your one stop functional survival kit. **Sorry, international shipping is not available.**

List Price: \$61.99  
Your Price: \$49.99



### Buy The Book This Site Is Based On

U.S. Army Field Manual 21-76 is the source material for this website. The U.S. Army Survival Manual covers a broad area of proven survival techniques. Topics include survival at sea, in jungles, desert and arctic regions. This manual, which is used throughout the U.S. Military, contains many useful illustrations and diagrams. Other topics include the procurement of potable water, food from animals and edible plants, finding directions using the sun or stars, and locating or making shelter. This is the finest, most proven book available on wilderness survival. It also includes guides on surviving a chemical, nuclear, or biological attack.

[Click here to buy it now on Amazon.com](#)

Check out the [Amazon Coupons](#) first to get the best deal.

*As seen in:*

*U.S. News and World Report  
Best of the Web - Site of the Week 8/6/01*

*Discovery Channel Canada  
One Week in the Wilderness*

Copyright © 2001-2002 Jalic LLC. All Rights Reserved.  
[Disclaimer](#) | [Privacy Policy](#) | [Advertise Here](#) | [Contact Us](#)



# Amazon Coupons

**Articles**

- PC Buying Guide
- Digital Camera Buying Guide
- Rare Item Buying Guide
- Broadband Buying Guide
- Home Network Buying Guide

**Coupons**

- 1800Flowers Coupons
- Alibris Coupons
- AllPosters.com Coupons
- Amazon Coupons
- Avon Coupons
- Bare Necessities Coupons
- Barnes and Noble Coupons
- Beauty.com Coupons
- Best Buy Coupons
- Blue Nile Coupons
- Bluefly Coupons
- Boscovs Coupons
- Buy.com Coupons
- Circuit City Coupons
- CompUSA Coupons
- Computers4Sure Coupons
- Crucial Coupons
- Delias Coupons
- Dell Coupons
- Dell Business Coupons
- Dell Canada Coupons
- Drugstore.com Coupons
- Dunham's Sports Coupons
- eBags Coupons
- Expedia Coupons
- Gap Coupons
- Gateway Coupons
- Home Depot Coupons
- HSN Coupons
- IBM Coupons
- Ice.com Coupons
- Kmart Coupons
- Lands End Coupons
- Macys Coupons
- Office Depot Coupons
- Office Max Coupons
- Old Navy Coupons
- Overstock.com Coupons
- Payless Coupons
- Priceline Coupons
- Sears Coupons
- Sharper Image Coupons
- Sierra Trading Post Coupons
- Staples Coupons
- Target Coupons
- Tech Depot Coupons
- Travelocity Coupons
- Vacation Outlet Coupons
- Viking Coupons

Chances are you're visiting this page via a link from one of my other sites. I use Amazon.com a lot, and I also encourage my visitors to shop there by including their links on my site. However I always want to make sure that my visitors get the best deal at Amazon.com, so I have made this page to inform them of Amazon.com coupons and other deals. Before you shop on Amazon.com I recommend you visit this page to keep up to date on the current deals, offers, and coupon codes.

To use the Amazon coupon codes listed below simply follow the link to Amazon.com, make your order, and then type in the coupon code in the appropriate spot before you confirm your order, you should see the discount reflected in an updated invoice.

**Hot Deal** - If you shop at Amazon.com I recommend you get the Amazon.com Visa (I have one). You get 1% cash back (in the form of certificates) on all purchases, which is as good as any other cash back card. You also get **3% cash back** (in the form of certificates) at Amazon. So that DVD player that is 10% off at Amazon is really 13% off if you have this card. It makes Amazon's sweet deals even sweeter. For a limited time they're also giving you a straight cash bonus just for signing up. Also you'll get all the benefits of a Visa platinum card like free travel insurance, rental insurance, and all the rest. Even if you only use this card when shopping on Amazon it is still worth it as there is no annual fee.

By the way, if you're in the market for a new computer, or even if you're just thinking about it, **Dell has really good deals. Check out our Dell Coupons.**

Amazon Coupons				
Type	Merchant	Offer	Exp.	Code/Link
<div style="border: 1px dashed black; padding: 2px; display: inline-block;">Coupon</div> <small>Amazon Coupons</small>	<a href="#">Amazon</a>	Purchase one of the linked-to KitchenAid mixers offered by Amazon.com and receive a two free gifts via mail-in rebate. Link driveon coupon	Limited Time	<a href="#">Click Here</a>
<div style="border: 1px dashed black; padding: 2px; display: inline-block;">Coupon</div> <small>Amazon Coupons</small>	<a href="#">Amazon</a>	FREE Camcorder Kit w/ \$300 camcorder purchase	Unknown	<a href="#">FRCMCRDRKT44</a>

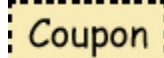
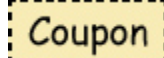
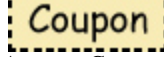
Walmart Coupons  
Yankee Candle Coupons

**Deals**

- Hard Drive Deals
- Monitor Deals
- CD & DVD Burner Deals
- Memory Deals
- Desktop Deals
- Laptop Deals
- Networking Deals
- TV Deals
- Digital Camera Deals
- Tivo Deals
- Travel Deals
- Cruise Deals
- Hotel Deals
- DVD Player Deals
- Jewelry Deals











**Marketplace**

- TVs
- DVD Players
- Tivo
- Digital Camcorders
- Computer Add-Ons
- Desktops
- Laptops
- Digital Cameras
- Textbooks
- Jewelry






 Amazon Coupons	<a href="#">Amazon</a>	<b>Hot Deal</b> Buy two Playstation 2 games and get a third <b>FREE!</b> - Why not pick up a copy of the award winning "Splinter Cell," just released for the PS2.	Unknown	<a href="#">LPS2SFTRGAME</a>
 Amazon Coupons	<a href="#">Amazon</a>	Get a free game with the purchase of a GameCube.	Unknown	<a href="#">ZERGCMPYFREE</a>
 Amazon Coupons	<a href="#">Amazon</a>	<b>Free</b> Blackberry PDA after rebate	September 8th, 2004	<a href="#">Click Here</a>

**Amazon Coupons**

**Amazon Sales**






Type	Merchant	Offer	Exp.	Code/Link
 Amazon Sales	<a href="#">Amazon</a>	FREE Shipping with \$25 purchase	Ongoing	<a href="#">Click Here</a>
 Amazon Sales	<a href="#">Amazon</a>	Electronics Outlet: <b>Save Hundreds!</b>	Ongoing	<a href="#">Click Here</a>
 Amazon Sales	<a href="#">Amazon</a>	Save on all Linksys Home Networking Products.	Ongoing	<a href="#">Click Here</a>
 Amazon Sales	<a href="#">Amazon</a>	Deals of the Day	Ongoing	<a href="#">Click Here</a>
 Amazon Sales	<a href="#">Amazon</a>	Clearance Outlet: Up to 75% off	Ongoing	<a href="#">Click Here</a>
 Amazon Sales	<a href="#">Amazon</a>	Electronics products with money-back rebate offers	Ongoing	<a href="#">Click Here</a>
 Amazon Sales	<a href="#">Amazon</a>	Save up to 40% on top 100 bestseller books	Ongoing	<a href="#">Click Here</a>
 Amazon Sales	<a href="#">Amazon</a>	Lowest Prices Guaranteed in Tools and Hardware - If you find a better price elsewhere, Amazon.com will match that price and beat it by 10% of the difference!	Ongoing	<a href="#">Click Here</a>
 Amazon Sales	<a href="#">Amazon</a>	Save Hundreds on Digital Camcorders.	Ongoing	<a href="#">Click Here</a>
 Amazon Sales	<a href="#">Amazon</a>	Friday One Day Sale Up to 80% off. Check every Friday.	Ongoing	<a href="#">Click Here</a>



 Amazon Sales	<a href="#">Amazon</a>	All TVs on sale. Some up to \$500 off.	Ongoing	<a href="#">Click Here</a>
 Amazon Sales	<a href="#">Amazon</a>	Tivo's on sale at Amazon.com. This is a hot gift item. Plus now you can get a <b>\$50 rebate</b> . Buy one, it will change your life.	Ongoing	<a href="#">Click Here</a>
 Amazon Sales	<a href="#">Amazon</a>	Find great discounts at Amazon's jewelry section.	Ongoing	<a href="#">Click Here</a>
 Amazon Sales	<a href="#">Amazon</a>	Enjoy great sale prices on all photo printers offered by Amazon.com that normally sell for \$179.99 or more	Unknown	<a href="#">Click Here</a>
 Amazon Sales	<a href="#">Amazon</a>	Sale on all Microsoft networking products offered by Amazon.com.	Unknown	<a href="#">Click Here</a>

## Amazon Sales

## Amazon Deals & Discounts

Type	Merchant	Offer	Exp.	Code/Link
 Amazon Deals	<a href="#">Amazon</a>	<b>Hot Deal</b> Get \$300 off KitchenAid's Hard Anodized cookware set, only \$99. Then spend an additional \$25 on kitchen items and get an instance Amazon discount of \$25 making the second item(s) free.	Limited Time	<a href="#">Click Here</a>
 Amazon Deals	<a href="#">Amazon</a>	Get a top of the line DVD burner for only <b>\$164.99</b> after rebates. Burns DVDs at 4x speed, and CDs at 16x.	Ongoing	<a href="#">Click Here</a>
 Amazon Deals	<a href="#">Amazon</a>	<b>Linksys 54g (802.11g)</b> high speed home networking equipment on sale for as much as <b>41% off</b> . Wirelessly network your home for less at Amazon.com	Ongoing	<a href="#">Click Here</a>
 Amazon Deals	<a href="#">Amazon</a>	<b>Hot Deal</b> - Get an Amazon.com Visa and get <b>3% cash back</b> on all Amazon.com purchases (1% on other purchases). For a limited time save \$20 on your first Amazon purchase with this card.	Ongoing	<a href="#">Click Here</a>
 Amazon Deals	<a href="#">Amazon</a>	Get a DVD player for less than \$50.	Ongoing	<a href="#">Click Here</a>

## Amazon Deals & Discounts

# Amazon.com Top Sellers for Today

DVDs Kitchen Tools & Hardware Electronics

## Report Expired/New Amazon Coupons

Please **contact us** to report expired Amazon coupons or to let us know about Amazon coupons, Amazon promotions & discounts, or Amazon sales we do not have listed.

## How to Use Amazon Coupons

The Amazon Coupons on this site come in two forms:

- **Link Driven Coupons.** These coupons are used simply by clicking on a link. The link will take you to the merchants page through a special link that tags you with the discount. When you proceed to check out the coupon should appear automatically. If you let too much time pass before checking out you may need to return to this site and click the link again.
- **Code Driven Coupons.** These coupons are activated with the coupon code provided. Typically merchants will have an input box for coupons at some point in the checkout process. You simply need to enter the coupon code provided on this site into the appropriate box for coupons on the merchant's site and the discount will be applied.



Services We Offer

[Web Development](#)

[Search Engine](#)

[Optimization](#)

Sites We Publish

[Web Templates](#)

[Discount Diet Food](#)

[Dell Coupons](#)

[Lord of the Rings Swords](#)

[More Sites »](#)

**Welcome to Jalic.com**  
Just a Little Internet Company

## Jalic

In the US alone over 160 million people are online, with that number increasing daily. 8 in 10 of those online will shop or research businesses online, creating a market of billions. With such massive usage statistics and amazing growth how can your business afford not to be online?

The Internet is unique in that everyone is on an even playing field. You may not be able to put a store on every corner, or in every town. Instead, you can put your store or business right in the home of every Internet user on Earth. With the Internet you don't need a store on every corner to reach people, all you need is a website, and you'll be able to reach over 160 million Americans.

If you currently advertise your business then you absolutely need to have a website. You are limited with traditional advertising, either in size or by time, and you can't always get your entire message across. By using the power of the Internet and building a website you can include your URL with all your advertisements so potential clients can learn more about your business, or maybe even shop online. If you don't have a website you're losing out on these potential customers, customers who may be looking at your competitor's website right now.

Let Jalic be your guide in the cyber world. Our employees have been making websites for 9 years. Our sites are always top of the line in design and quality. We can make a website to fit your needs and your desires, but our service goes beyond just the website, we can consult you on how to get your business out there so that people will come to your site. We can advise you on the best Internet advertising methods, and we can make sure your site is optimized for search engines. Our ability to get your site a high search engine ranking is our strong point and it is what sets us above the rest.

Here at Jalic we value customer satisfaction as priority #1. In keeping with this our prices are generally lower than a competitors for the same quality of design, and if thats not enough, we offer a full money back guarantee on some projects. Don't go through the anxiety of wondering if your website will turn out as you want it. We also do not engage in price discrimination. Even if you could afford more than what we charge we won't increase our prices. We value the trust out clients give to us and so honesty is important with us. If we can help you save money, even if it means we'll be making less, we'll do it.

To learn more about our products and services you can use the menu at the top of the page. Please [contact us](#) if you have any questions.



## Orienteering Home

### The Sport:

- **Orienteering History**

- **Orienteering**

### Overview

- **Course Setup**

- **Officials**

- **Start/Finish Areas**

- **Course Safety**

- **Control Point**

### Guidelines

- **Map Symbols**

- **Orienteering**

### Techniques

- **Civilian Orienteering**

All of the information contained within this website is provided for educational use only. By using this website you agree that you will not hold the owners of this website liable for any event that should happen as a result of you following the information provided within this website. Use the information provided within this website at your own risk. The information within this website is provided as-is without warranty of guarantee of any kind.

The information on this site is from U.S. Army Field Manual 21-26. "Map Reading and Land Navigation"

### The Skills:

- **Maps**

- **Marginal Information**

### and Symbols

- **Grids**

- **Scale and Distance**

- **Direction**

- **Overlays**

- **Aerial Photographs**

- **Navigation**

### Equipment and

### Methods

- **Elevation and Relief**

- **Terrain Association**

- **Navigation in**

### Different Types of

### Terrain

- **Field Sketching**

- **Map Folding**

### Techniques

- **Units of Measure and**

### Conversion Factors

Check out the **Amazon Coupons** before you buy.

Copyright © 2001-2002 Jalic LLC. All Rights Reserved.

**Disclaimer | Privacy Policy | Contact Us**





## Orienteering Home

### The Sport:

- [Orienteering History](#)
- [Orienteering](#)

### Overview

- [Course Setup](#)
- [Officials](#)
- [Start/Finish Areas](#)
- [Course Safety](#)
- [Control Point](#)

### Guidelines

- [Map Symbols](#)
- [Orienteering](#)

### Techniques

- [Civilian Orienteering](#)

### The Skills:

- [Maps](#)
- [Marginal Information and Symbols](#)
- [Grids](#)
- [Scale and Distance](#)
- [Direction](#)
- [Overlays](#)
- [Aerial Photographs](#)
- [Navigation](#)

### Equipment and

### Methods

- [Elevation and Relief](#)
- [Terrain Association](#)
- [Navigation in](#)

### Different Types of Terrain

- [Field Sketching](#)
- [Map Folding](#)

### Techniques

- [Units of Measure and Conversion Factors](#)

## Privacy Statement for Online-Orienteering.net

Jalic LLC has created this privacy statement in order to demonstrate our firm commitment to privacy. The following discloses our information gathering and dissemination practices for this website: Fitness Training.

We use your IP address to help diagnose problems with our server, and to administer our Web site. Your IP address is used to help identify you and to gather broad demographic information.

Our site uses cookies to make sure you don't see the same ad repeatedly.

Our site's registration form requires users to give us demographic information (like their zip code, age, or income level). Demographic and profile data is also collected at our site. We use this data to tailor the visitor's experience at our site, showing them content that we think they might be interested in, and displaying the content according to their preferences. This information is shared with advertisers on an aggregate basis.

We use an outside ad company to display ads on our site. These ads may contain cookies. While we use cookies in other parts of our Web site, cookies received with banner ads are collected by our ad company, and we do not have access to this information. Some customer data is shared with the advertising companies.

Check out the [Amazon Coupons](#) before you buy.

Copyright © 2001-2002 Jalic LLC. All Rights Reserved.

[Disclaimer](#) | [Privacy Policy](#) | [Contact Us](#)







## Orienteering Home

To contact us please write to [webmaster\\_at\\_online-orienteeing.net](mailto:webmaster_at_online-orienteeing.net), replacing [\\_at\\_](mailto:webmaster_at_online-orienteeing.net) with the @ symbol. I need to present my email address like this because of spam robots that scour the Internet looking for email addresses. Its very annoying and it hinders valid communication. If there is ever a bill regulating commercial email make sure you support it.

Alternatively you can use the form below:

Your Name:

Your Email:

Subject:

### The Sport:

- **Orienteering History**

- **Orienteering**

#### Overview

- **Course Setup**

- **Officials**

- **Start/Finish Areas**

- **Course Safety**

- **Control Point**

#### Guidelines

- **Map Symbols**

- **Orienteering**

#### Techniques

- **Civilian Orienteering**

### The Skills:

- **Maps**

- **Marginal Information**

#### and Symbols

- **Grids**

- **Scale and Distance**

- **Direction**

- **Overlays**

- **Aerial Photographs**

- **Navigation**

#### Equipment and

#### Methods

- **Elevation and Relief**

- **Terrain Association**

- **Navigation in**

#### Different Types of

#### Terrain

- **Field Sketching**

- **Map Folding**

#### Techniques

- **Units of Measure and**

#### Conversion Factors

Check out the **Amazon Coupons** before you buy.

Copyright © 2001-2002 Jalic LLC. All Rights Reserved.

[Disclaimer](#) | [Privacy Policy](#) | [Contact Us](#)





**Orienteering Home**

**The Sport:**

- **Orienteering History**
- **Orienteering**

**Overview**

- **Course Setup**
- **Officials**
- **Start/Finish Areas**
- **Course Safety**
- **Control Point**

**Guidelines**

- **Map Symbols**
- **Orienteering**

**Techniques**

- **Civilian Orienteering**

**The Skills:**

- **Maps**
- **Marginal Information and Symbols**
- **Grids**
- **Scale and Distance**
- **Direction**
- **Overlays**
- **Aerial Photographs**
- **Navigation**

**Equipment and**

**Methods**

- **Elevation and Relief**
- **Terrain Association**
- **Navigation in**

**Different Types of Terrain**

- **Field Sketching**
- **Map Folding**

**Techniques**

- **Units of Measure and Conversion Factors**

## Definition

A map is a graphic representation of a portion of the earth's surface drawn to scale, as seen from above. It uses colors, symbols, and labels to represent features found on the ground. The ideal representation would be realized if every feature of the area being mapped could be shown in true shape.

Obviously this is impossible, and an attempt to plot each feature true to scale would result in a product impossible to read even with the aid of a magnifying glass.

a. Therefore, to be understandable, features must be represented by conventional signs and symbols. To be legible, many of these must be exaggerated in size, often far beyond the actual ground limits of the feature represented. On a 1:250,000 scale map, the prescribed symbol for a building covers an area about 500 feet square on the ground; a road symbol is equivalent to a road about 520 feet wide on the ground; the symbol for a single-track railroad (the length of a cross-tie) is equivalent to a railroad cross-tie about 1,000 feet on the ground.

b. The portrayal of many features requires similar exaggeration. Therefore, the selection of features to be shown, as well as their portrayal, is in accord with the guidance established by the Defense Mapping Agency.

[Back to Maps](#)

Check out the **Amazon Coupons** before you buy.

Copyright © 2001-2002 Jalic LLC. All Rights Reserved.

**Disclaimer | Privacy Policy | Contact Us**





[Orienteering Home](#)

## Purpose

### The Sport:

- [Orienteering History](#)
- [Orienteering](#)

### Overview

- [Course Setup](#)
- [Officials](#)
- [Start/Finish Areas](#)
- [Course Safety](#)
- [Control Point](#)

### Guidelines

- [Map Symbols](#)
- [Orienteering](#)

### Techniques

- [Civilian Orienteering](#)

A map provides information on the existence, the location of, and the distance between ground features, such as populated places and routes of travel and communication. It also indicates variations in terrain, heights of natural features, and the extent of vegetation cover. With our military forces dispersed throughout the world, it is necessary to rely on maps to provide information to our combat elements and to resolve logistical operations far from our shores. Soldiers and materials must be transported, stored, and placed into operation at the proper time and place. Much of this planning must be done by using maps. Therefore, any operation requires a supply of maps; however, the finest maps available are worthless unless the map user knows how to read them.

[Back to Maps](#)

### The Skills:

- [Maps](#)
- [Marginal Information and Symbols](#)

Check out the [Amazon Coupons](#) before you buy.

- [Grids](#)
- [Scale and Distance](#)
- [Direction](#)
- [Overlays](#)

Copyright © 2001-2002 Jalic LLC. All Rights Reserved.

[Disclaimer](#) | [Privacy Policy](#) | [Contact Us](#)

- [Aerial Photographs](#)
- [Navigation](#)

### Equipment and

### Methods

- [Elevation and Relief](#)
- [Terrain Association](#)
- [Navigation in](#)

### Different Types of Terrain

- [Field Sketching](#)
- [Map Folding](#)

### Techniques

- [Units of Measure and Conversion Factors](#)







[Orienteering Home](#)

The Sport:

- [Orienteering History](#)
- [Orienteering](#)

Overview

- [Course Setup](#)
- [Officials](#)
- [Start/Finish Areas](#)
- [Course Safety](#)
- [Control Point](#)

Guidelines

- [Map Symbols](#)
- [Orienteering](#)

Techniques

- [Civilian Orienteering](#)

The Skills:

- [Maps](#)
- [Marginal Information and Symbols](#)
- [Grids](#)
- [Scale and Distance](#)
- [Direction](#)
- [Overlays](#)
- [Aerial Photographs](#)
- [Navigation](#)

Equipment and

Methods

- [Elevation and Relief](#)
- [Terrain Association](#)
- [Navigation in](#)

Different Types of Terrain

- [Field Sketching](#)
- [Map Folding](#)

Techniques

- [Units of Measure and Conversion Factors](#)

## Care of Maps

Maps are documents printed on paper and require protection from water, mud, and tearing. Whenever possible, a map should be carried in a waterproof case, in a pocket, or in some other place where it is handy for use but still protected.

a. Care must also be taken when using a map since it may have to last a long time. If it becomes necessary to mark a map, the use of a pencil is recommended. Use light lines so they may be erased easily without smearing and smudging, or leaving marks that may cause confusion later. If the map margins must be trimmed for any reason, it is essential to note any marginal information that may be needed later, such as grid data and magnetic declination.

b. Special care should be taken of a map that is being used in a tactical mission, especially in small units; the mission may depend on that map. All members of such units should be familiar with the map's location at all times.

c. [Appendix B](#) shows two ways of folding a map.

[Back to Maps](#)

Check out the [Amazon Coupons](#) before you buy.

Copyright © 2001-2002 Jalic LLC. All Rights Reserved.

[Disclaimer](#) | [Privacy Policy](#) | [Contact Us](#)





[Orienteering Home](#)

The Sport:

- [Orienteering History](#)
- [Orienteering Overview](#)

Overview

- [Course Setup](#)
- [Officials](#)
- [Start/Finish Areas](#)
- [Course Safety](#)
- [Control Point](#)

Guidelines

- [Map Symbols](#)
- [Orienteering Techniques](#)

Techniques

- [Civilian Orienteering](#)

The Skills:

- [Maps](#)
- [Marginal Information and Symbols](#)
- [Grids](#)
- [Scale and Distance](#)
- [Direction](#)
- [Overlays](#)
- [Aerial Photographs](#)
- [Navigation](#)

Equipment and Methods

- [Elevation and Relief](#)
- [Terrain Association](#)
- [Navigation in Different Types of Terrain](#)

Different Types of Terrain

- [Field Sketching](#)
- [Map Folding](#)

Techniques

- [Units of Measure and Conversion Factors](#)

## Map Categories

The DMA's mission is to provide mapping, charting, and all geodesy support to the armed forces and all other national security operations. DMA produces four categories of products and services: hydrographic, topographic, aeronautical, and missile and targeting. Military maps are categorized by scale and type.

- a. **Scale.** Because a map is a graphic representation of a portion of the earth's surface drawn to scale as seen from above, it is important to know what mathematical scale has been used. You must know this to determine ground distances between objects or locations on the map, the size of the area covered, and how the scale may affect the amount of detail being shown. The mathematical scale of a map is the ratio or fraction between the distance on a map and the corresponding distance on the surface of the earth. Scale is reported as a representative fraction with the map distance as the numerator and the ground distance as the denominator.

$$\text{Representative fraction (scale)} = \frac{\text{map distance}}{\text{ground distance}}$$

As the denominator of the representative fraction gets larger and the ratio gets smaller, the scale of the map decreases. Defense Mapping Agency maps are classified by scale into three categories. They are small-, medium-, and large-scale maps (Figure 2-1). The terms "**small scale**," "**medium scale**," and "**large scale**" may be confusing when read in conjunction with the number. However, if the number is viewed as a fraction, it quickly becomes apparent that 1:600,000 of something is smaller than 1:75,000 of the same thing. Therefore, the larger the number after 1:, the smaller the scale of the map.

Figure 2-1. Scale classifications.

**Figure 2-1. Scale classifications.**

- (1) **Small.** Those maps with scales of 1:1,000,000 and smaller are used for general planning and for strategic studies (bottom map in Figure 2-1). The standard small-scale map is 1:1,000,000. This map covers a very large land area at the expense of detail.

(2) **Medium.** Those maps with scales larger than 1:1,000,000 but smaller than 1:75,000 are used for operational planning (center map in Figure 2-1). They contain a moderate amount of detail, but terrain analysis is best done with the large-scale maps described below. The standard medium-scale map is 1:250,000. Medium scale maps of 1:100,000 are also frequently encountered.

(3) **Large.** Those maps with scales of 1:75,000 and larger are used for tactical, administrative, and logistical planning (top map in Figure 2-1). These are the maps that you as a soldier or junior leader are most likely to encounter. The standard large-scale map is 1:50,000; however, many areas have been mapped at a scale of 1:25,000.

b. **Types.** The map of choice for land navigators is the 1:50,000-scale military topographic map. It is important, however, that you know how to use the many other products available from the DMA as well. When operating in foreign places, you may discover that DMA map products have not yet been produced to cover your particular area of operations, or they may not be available to your unit when you require them. Therefore, you must be prepared to use maps produced by foreign governments that may or may not meet the standards for accuracy set by DMA. These maps often use symbols that resemble those found on DMA maps but which have completely different meanings. There may be other times when you must operate with the only map you can obtain. This might be a commercially produced map run off on a copy machine at higher headquarters. In Grenada, many of our troops used a British tourist map.

(1) **Planimetric Map.** This is a map that presents only the horizontal positions for the features represented. It is distinguished from a topographic map by the omission of relief, normally represented by contour lines. Sometimes, it is called a line map.

(2) **Topographic Map.** This is a map that portrays terrain features in a measurable way (usually through use of contour lines), as well as the horizontal positions of the features represented. The vertical positions, or relief, are normally represented by contour lines on military topographic maps. On maps showing relief, the elevations and contours are measured from a specific vertical datum plane, usually mean sea level. Figure 3-1 shows a typical topographic map.

(3) **Photomap.** This is a reproduction of an aerial photograph upon which grid lines, marginal data, place names, route numbers, important elevations, boundaries, and approximate scale and direction have been added.

(4) **Joint Operations Graphics.** These maps are based on the format of standard 1:250,000 medium-scale military topographic maps, but they contain additional information needed in joint air-ground operations (Figure 2-2). Along the north and east edges of the graphic, detail is extended beyond the standard map sheet to provide overlap with adjacent sheets. These maps are produced

both in ground and air formats. Each version is identified in the lower margin as either Joint Operations Graphic (Air) or Joint Operations Graphic (Ground). The topographic information is identical on both, but the ground version shows elevations and contour in meters and the air version shows them in feet. Layer (elevation) tinting and relief shading are added as an aid to interpolating relief. Both versions emphasize airlanding facilities (shown in purple), but the air version has additional symbols to identify aids and obstructions to air navigation.

Figure 2-2. Joint operations graphic (air).

**Figure 2-2. Joint operations graphic (air).**

(5) **Photomosaic.** This is an assembly of aerial photographs that is commonly called a mosaic in topographic usage. Mosaics are useful when time does not permit the compilation of a more accurate map. The accuracy of a mosaic depends on the method employed in its preparation and may vary from simply a good pictorial effect of the ground to that of a planimetric map.

(6) **Terrain Model.** This is a scale model of the terrain showing features, and in large-scale models showing industrial and cultural shapes. It provides a means for visualizing the terrain for planning or indoctrination purposes and for briefing on assault landings.

(7) **Military City Map.** This is a topographic map (usually at 1:12,550 scale, sometimes up to 1:5,000), showing the details of a city. It delineates streets and shows street names, important buildings, and other elements of the urban landscape important to navigation and military operations in urban terrain. The scale of a military city map depends on the importance and size of the city, density of detail, and available intelligence information.

(8) **Special Maps.** These are maps for special purposes, such as trafficability, communications, and assault maps. They are usually in the form of an overprint in the scales smaller than 1:100,000 but larger than 1:1,000,000. A special purpose map is one that has been designed or modified to give information not covered on a standard map. The wide range of subjects that could be covered under the heading of special purpose maps prohibits, within the scope of this manual, more than a brief mention of a few important ones. Some of the subjects covered are:

- Terrain features.
- Drainage characteristics.
- Vegetation.
- Climate.
- Coasts and landing beaches.



- Roads and bridges.
- Railroads.
- Airfields.
- Urban areas.
- Electric power.
- Fuels.
- Surface water resources.
- Ground water resources.
- Natural construction materials.
- Cross-country movements.
- Suitability for airfield construction.
- Airborne operations.

[Back to Maps](#)

Check out the **Amazon Coupons** before you buy.

Copyright © 2001-2002 Jalic LLC. All Rights Reserved.

**[Disclaimer](#) | [Privacy Policy](#) | [Contact Us](#)**



[Orienteering Home](#)

## Marginal Information on a Military Map

### The Sport:

- [Orienteering History](#)
- [Orienteering](#)

### Overview

- [Course Setup](#)
- [Officials](#)
- [Start/Finish Areas](#)
- [Course Safety](#)
- [Control Point](#)

### Guidelines

- [Map Symbols](#)
- [Orienteering](#)

### Techniques

- [Civilian Orienteering](#)

### The Skills:

- [Maps](#)
- [Marginal Information and Symbols](#)

- [Grids](#)
- [Scale and Distance](#)
- [Direction](#)
- [Overlays](#)

- [Aerial Photographs](#)
- [Navigation](#)

### Equipment and Methods

- [Elevation and Relief](#)
- [Terrain Association](#)
- [Navigation in](#)

### Different Types of Terrain

- [Field Sketching](#)
- [Map Folding](#)

### Techniques

- [Units of Measure and Conversion Factors](#)

Figure 3-1 shows a reduced version of a large-scale topographic map. The circled numbers indicate the items of marginal information that the map user needs to know. These circled numbers correspond to the following listed items.

- a. **Sheet Name (1).** The sheet name is found in bold print at the center of the top and in the lower left area of the map margin. A map is generally named for the settlement contained within the area covered by the sheet, or for the largest natural feature located within the area at the time the map was drawn.
- b. **Sheet Number (2).** The sheet number is found in bold print in both the upper right and lower left areas of the margin, and in the center box of the adjoining sheets diagram, which is found in the lower right margin. It is used as a reference number to link specific maps to overlays, operations orders, and plans. For maps at 1:100,000 scale and larger, sheet numbers are based on an arbitrary system that makes possible the ready orientation of maps at scales of 1:100,000, 1:50,000, and 1:25,000.
- c. **Series Name (3).** The map series name is found in the same bold print as the sheet number in the upper left corner of the margin. The name given to the series is generally that of a major political subdivision, such as a state within the United States or a European nation. A map series usually includes a group of similar maps at the same scale and on the same sheet lines or format designed to cover a particular geographic area. It may also be a group of maps that serve a common purpose, such as the military city maps.
- d. **Scale (4).** The scale is found both in the upper left margin after the series name, and in the center of the lower margin. The scale note is a representative fraction that gives the ratio of a map distance to the corresponding distance on the earth's surface. For example, the scale note 1:50,000 indicates that one unit of measure on the map equals 50,000 units of the same measure on the ground.
- e. **Series Number (5).** The series number is found in both the upper right margin and the lower left margin. It is a sequence reference expressed either as a four-digit numeral (1125) or as a letter, followed by a three- or four-digit numeral (M661; T7110).
- f. **Edition Number (6).** The edition number is found in bold print in the upper right area of the top margin and the lower left area of the bottom

margin. Editions are numbered consecutively; therefore, if you have more than one edition, the highest numbered sheet is the most recent. Most military maps are now published by the DMA, but older editions of maps may have been produced by the US Army Map Service. Still others may have been drawn, at least in part, by the US Army Corps of Engineers, the US Geological Survey, or other agencies affiliated or not with the United States or allied governments. The credit line, telling who produced the map, is just above the legend. The map information date is found immediately below the word "LEGEND" in the lower left margin of the map. This date is important when determining how accurately the map data might be expected to match what you will encounter on the ground.

g. **Index to Boundaries (7).** The index to boundaries diagram appears in the lower or right margin of all sheets. This diagram, which is a miniature of the map, shows the boundaries that occur within the map area, such as county lines and state boundaries.

h. **Adjoining Sheets Diagram (8).** Maps at all standard scales contain a diagram that illustrates the adjoining sheets. On maps at 1:100,000 and larger scales and at 1:1,000,000 scale, the diagram is called the index to adjoining sheets. It consists of as many rectangles representing adjoining sheets as are necessary to surround the rectangle that represents the sheet under consideration. The diagram usually contains nine rectangles, but the number may vary depending on the locations of the adjoining sheets. All represented sheets are identified by their sheet numbers. Sheets of an adjoining series, whether published or planned, that are at the same scale are represented by dashed lines. The series number of the adjoining series is indicated along the appropriate side of the division line between the series.

i. **Elevation Guide (9).** This is normally found in the lower right margin. It is a miniature characterization of the terrain shown. The terrain is represented by bands of elevation, spot elevations, and major drainage features. The elevation guide provides the map reader with a means of rapid recognition of major landforms.

j. **Declination Diagram (10).** This is located in the lower margin of large-scale maps and indicates the angular relationships of true north, grid north, and magnetic north. On maps at 1:250,000 scale, this information is expressed as a note in the lower margin. In recent edition maps, there is a note indicating the conversion of azimuths from grid to magnetic and from magnetic to grid next to the declination diagram.

k. **Bar Scales (11).** These are located in the center of the lower margin. They are rulers used to convert map distance to ground distance. Maps have three or more bar scales, each in a different unit of measure. Care should be exercised when using the scales, especially in the selection of the unit of measure that is needed.

l. **Contour Interval Note (12).** This note is found in the center of the lower margin normally below the bar scales. It states the vertical distance between adjacent contour lines of the map. When supplementary contours are used, the interval is indicated. In recent edition maps, the contour interval is given in meters instead of feet.

m. **Spheroid Note (13).** This note is located in the center of the lower

margin. Spheroids (ellipsoids) have specific parameters that define the X Y Z axis of the earth. The spheroid is an integral part of the datum.

n. **Grid Note (14).** This note is located in the center of the lower margin. It gives information pertaining to the grid system used and the interval between grid lines, and it identifies the UTM grid zone number.

o. **Projection Note (15).** The projection system is the framework of the map. For military maps, this framework is of the conformal type; that is, small areas of the surface of the earth retain their true shapes on the projection; measured angles closely approximate true values; and the scale factor is the same in all directions from a point. The projection note is located in the center of the lower margin. Refer to DMA for the development characteristics of the conformal-type projection systems.

(1) Between 80° south and 84° north, maps at scales larger than 1:500,000 are based on the transverse Mercator projection. The note reads TRANSVERSE MERCATOR PROJECTION.

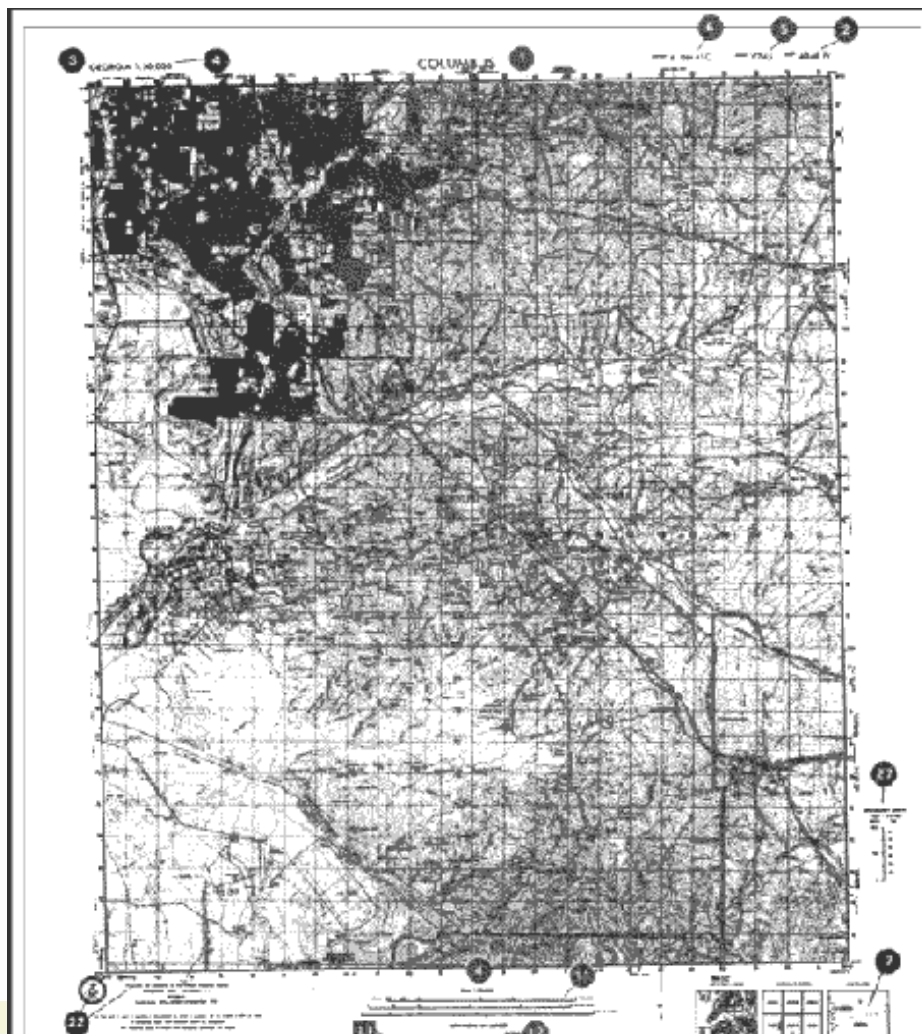
(2) Between 80° south and 84° north, maps at 1:1,000,000 scale and smaller are based on standard parallels of the Lambert conformal conic projection. The note reads, for example, LAMBERT CONFORMAL CONIC PROJECTIONS 36° 40' N AND 39° 20' N.

(3) Maps of the polar regions (south of 80° south and north of 84° north) at 1:1,000,000 and larger scales are based on the polar stereographic projection. The note reads POLAR STEREOGRAPHIC PROJECTION.

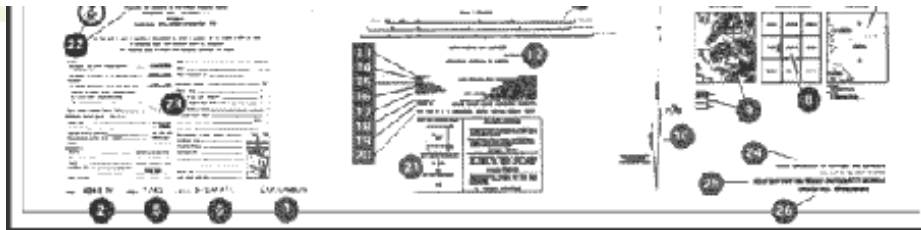
p. **Vertical Datum Note (16).** This note is located in the center of the lower margin. The vertical datum or vertical-control datum is defined as any level surface (for example, mean sea level) taken as a surface of reference from which to determine elevations. In the United States, Canada, and Europe, the vertical datum refers to the mean sea level surface. However, in parts of Asia and Africa, the vertical-control datum may vary locally and is based on an assumed elevation that has no connection to any sea level surface. Map readers should habitually check the vertical datum note on maps, particularly if the map is used for low-level aircraft navigation, naval gunfire support, or missile target acquisition.

q. **Horizontal Datum Note (17).** This note is located in the center of the lower margin. The horizontal datum or horizontal-control datum is defined as a geodetic reference point (of which five quantities are known: latitude, longitude, azimuth of a line from this point, and two constants, which are the parameters of reference ellipsoid). These are the basis for horizontal-control surveys. The horizontal-control datum may extend over a continent or be limited to a small local area. Maps and charts produced by DMA are produced on 32 different horizontal-control data. Map readers should habitually check the horizontal datum note on every map or chart, especially adjacent map sheets. This is to ensure the products are based on the same horizontal datum. If products are based on different horizontal-control data, coordinate transformations to a common datum must be performed. UTM coordinates from the same point computed on different data may differ as much as 900 meters.

- r. **Control Note (18).** This note is located in the center of the lower margin. It indicates the special agencies involved in the control of the technical aspects of all the information that is disseminated on the map.
- s. **Preparation Note (19).** This note is located in the center of the lower margin. It indicates the agency responsible for preparing the map.
- t. **Printing Note (20).** This note is also located in the center of the lower margin. It indicates the agency responsible for printing the map and the date the map was printed. The printing data should not be used to determine when the map information was obtained.
- u. **Grid Reference Box (21).** This box is normally located in the center of the lower margin. It contains instructions for composing a grid reference.
- v. **Unit imprint and Symbol (22).** The unit imprint and symbol is on the left side of the lower margin. It identifies the agency that prepared and printed the map with its respective symbol. This information is important to the map user in evaluating the reliability of the map.
- w. **Legend (23).** The legend is located in the lower left margin. It illustrates and identifies the topographic symbols used to depict some of the more prominent features on the map. The symbols are not always the same on every map. Always refer to the legend to avoid errors when reading a map.







**Figure 3-1. Topographical map.**

[Back to Marginal Information and Symbols](#)

Check out the [Amazon Coupons](#) before you buy.

Copyright © 2001-2002 Jalic LLC. All Rights Reserved.

[Disclaimer](#) | [Privacy Policy](#) | [Contact Us](#)





[Orienteering Home](#)

The Sport:

- [Orienteering History](#)

- [Orienteering](#)

Overview

- [Course Setup](#)

- [Officials](#)

- [Start/Finish Areas](#)

- [Course Safety](#)

- [Control Point](#)

Guidelines

- [Map Symbols](#)

- [Orienteering](#)

Techniques

- [Civilian Orienteering](#)

The Skills:

- [Maps](#)

- [Marginal Information and Symbols](#)

- [Grids](#)

- [Scale and Distance](#)

- [Direction](#)

- [Overlays](#)

- [Aerial Photographs](#)

- [Navigation](#)

- [Equipment and Methods](#)

- [Elevation and Relief](#)

- [Terrain Association](#)

- [Navigation in](#)

- [Different Types of Terrain](#)

- [Field Sketching](#)

- [Map Folding](#)

Techniques

- [Units of Measure and Conversion Factors](#)

- [Conversion Factors](#)

## Topographic Map Symbols

The purpose of a map is to permit one to visualize an area of the earth's surface with pertinent features properly positioned. The map's legend contains the symbols most commonly used in a particular series or on that specific topographic map sheet. Therefore, the legend should be referred to each time a new map is used. Every effort is made to design standard symbols that resemble the features they represent. If this is not possible, symbols are selected that logically imply the features they portray. For example, an open-pit mining operation is represented by a small black drawing of a crossed hammer and pickax.

a. Ideally, all the features within an area would appear on a map in their true proportion, position, and shape. This, however, is not practical because many of the features would be unimportant and others would be unrecognizable because of their reduction in size.

b. The mapmaker has been forced to use symbols to represent the natural and man-made features of the earth's surface. These symbols resemble, as closely as possible, the actual features themselves as viewed from above. They are positioned in such a manner that the center of the symbol remains in its true location. An exception to this would be the position of a feature adjacent to a major road. If the width of the road has been exaggerated, then the feature is moved from its true position to preserve its relation to the road. Field Manual 21-31 gives a description of topographic features and abbreviations authorized for use on our military maps.

[Back to Marginal Information and Symbols](#)

Check out the [Amazon Coupons](#) before you buy.

Copyright © 2001-2002 Jalic LLC. All Rights Reserved.

[Disclaimer](#) | [Privacy Policy](#) | [Contact Us](#)





[Orienteering Home](#)

The Sport:

- [Orienteering History](#)
- [Orienteering Overview](#)

- [Course Setup](#)
- [Officials](#)
- [Start/Finish Areas](#)
- [Course Safety](#)
- [Control Point](#)

Guidelines

- [Map Symbols](#)
- [Orienteering Techniques](#)

Techniques

- [Civilian Orienteering](#)

The Skills:

- [Maps](#)
- [Marginal Information and Symbols](#)
- [Grids](#)
- [Scale and Distance](#)
- [Direction](#)
- [Overlays](#)
- [Aerial Photographs](#)
- [Navigation](#)

Equipment and Methods

- [Elevation and Relief](#)
- [Terrain Association](#)
- [Navigation in Different Types of Terrain](#)

Different Types of Terrain

- [Field Sketching](#)
- [Map Folding](#)

Techniques

- [Units of Measure and Conversion Factors](#)

## Colors used on a Map

By the fifteenth century, most European maps were carefully colored. Profile drawings of mountains and hills were shown in brown, rivers and lakes in blue, vegetation in green, roads in yellow, and special information in red. A look at the legend of a modern map confirms that the use of colors has not changed much over the past several hundred years. To facilitate the identification of features on a map, the topographical and cultural information is usually printed in different colors. These colors may vary from map to map. On a standard large-scale topographic map, the colors used and the features each represent are:

- a. **Black.** Indicates cultural (man-made) features such as buildings and roads, surveyed spot elevations, and all labels.
- b. **Red-Brown.** The colors red and brown are combined to identify cultural features, all relief features, non-surveyed spot elevations, and elevation, such as contour lines on red-light readable maps.
- c. **Blue.** Identifies hydrography or water features such as lakes, swamps, rivers, and drainage.
- d. **Green.** Identifies vegetation with military significance, such as woods, orchards, and vineyards.
- e. **Brown.** Identifies all relief features and elevation, such as contours on older edition maps, and cultivated land on red-light readable maps.
- f. **Red.** Classifies cultural features, such as populated areas, main roads, and boundaries, on older maps.
- g. **Other.** Occasionally other colors may be used to show special information. These are indicated in the marginal information as a rule.

[Back to Marginal Information and Symbols](#)

Check out the **Amazon Coupons** before you buy.

Copyright © 2001-2002 Jalic LLC. All Rights Reserved.

**[Disclaimer](#) | [Privacy Policy](#) | [Contact Us](#)**



[Orienteering Home](#)

**The Sport:**

- [Orienteering History](#)
- [Orienteering](#)

**Overview**

- [Course Setup](#)
- [Officials](#)
- [Start/Finish Areas](#)
- [Course Safety](#)
- [Control Point](#)

**Guidelines**

- [Map Symbols](#)
- [Orienteering](#)

**Techniques**

- [Civilian Orienteering](#)

**The Skills:**

- [Maps](#)
- [Marginal Information and Symbols](#)
- [Grids](#)
- [Scale and Distance](#)
- [Direction](#)
- [Overlays](#)
- [Aerial Photographs](#)
- [Navigation](#)

**Equipment and Methods**

- [Elevation and Relief](#)
- [Terrain Association](#)
- [Navigation in](#)

**Different Types of Terrain**

- [Field Sketching](#)
- [Map Folding](#)

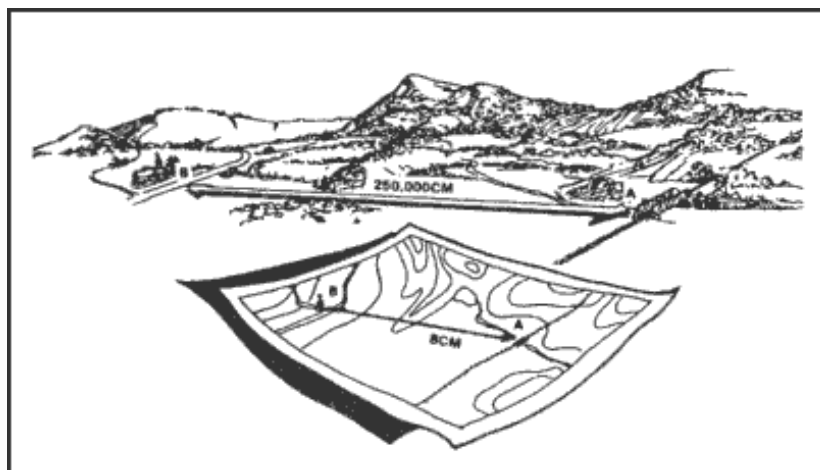
**Techniques**

- [Units of Measure and Conversion Factors](#)

## Representative Fraction

The numerical scale of a map indicates the relationship of distance measured on a map and the corresponding distance on the ground. This scale is usually written as a fraction and is called the representative fraction. The RF is always written with the map distance as 1 and is independent of any unit of measure. (It could be yards, meters, inches, and so forth. ) An RF of 1/50,000 or 1:50,000 means that one unit of measure on the map is equal to 50,000 units of the same measure on the ground.

- a. The ground distance between two points is determined by measuring between the same two points on the map and then multiplying the map measurement by the denominator of the RF or scale (Figure 5-1).



**Figure 5-1. Converting map distance to ground distance.**

**EXAMPLE:**

The map scale is 1:50,000

$$RF = 1/50,000$$

The map distance from point A to point B is 5 units

$$5 \times 50,000 = 250,000 \text{ units of ground distance}$$

- b. Since the distance on most maps is marked in meters and the RF is expressed in this unit of measurement in most cases, a brief description of

the metric system is needed. In the metric system, the standard unit of measurement is the meter.

1 meter contains 100 centimeters (cm).

100 meters is a regular football field plus 10 meters.

1,000 meters is 1 kilometer (km).

10 kilometers is 10,000 meters.

Appendix C contains the conversion tables.

c. The situation may arise when a map or sketch has no RF or scale. To be able to determine ground distance on such a map, the RF must be determined. There are two ways to do this:

(1) *Comparison with Ground Distance.*

(a) Measure the distance between two points on the map—map distance (MD).

(b) Determine the horizontal distance between these same two points on the ground—ground distance (GD).

(c) Use the RF formula and remember that RF must be in the general form:

$$RF = \frac{1}{X} = \frac{MD}{GD}$$

(d) Both the MD and the GD must be in the same unit of measure and the MD must be reduced to 1.

**EXAMPLE:**

*MD = 4.32 centimeters*

**GD = 2.16 kilometers**  
*(216,000 centimeters)*

$$RF = \frac{1}{X} = \frac{4.32}{216,000}$$

*or*

$$\frac{216,000}{4.32} = 50,000$$

*therefore*



$$RF = \frac{1}{50,000} \quad \text{or} \quad 1:50,000$$

**(2) Comparison With Another Map of the Same Area that Has an RF.**

- (a) Select two points on the map with the unknown RF. Measure the distance (MD) between them.
- (b) Locate those same two points on the map that have the known RF. Measure the distance (MD) between them. Using the RF for this map, determine GD, which is the same for both maps.
- (c) Using the GD and the MD from the first map, determine the RF using the formula:

$$RF = \frac{1}{X} = \frac{MD}{GD}$$

- d. Occasionally it may be necessary to determine map distance from a known ground distance and the RF:

$$MD = \frac{GD}{\text{Denominator or RF}}$$

*Ground Distance = 2,200 meters*

*RF = 1:50,000*

$$MD = \frac{2,200 \text{ meters}}{50,000}$$

*MD = 0.044 meters x 100 (centimeters per meter)*

*MD = 4.4 centimeters*

- e. When determining ground distance from a map, the scale of the map affects the accuracy. As the scale becomes smaller, the accuracy of measurement decreases because some of the features on the map must be exaggerated so that they may be readily identified.

**Back to Scale and Distance**

Check out the **Amazon Coupons** before you buy.





[Orienteering Home](#)

## Graphic (Bar) Scales

### The Sport:

- [Orienteering History](#)
- [Orienteering Overview](#)

### Overview

- [Course Setup](#)
- [Officials](#)
- [Start/Finish Areas](#)
- [Course Safety](#)
- [Control Point](#)

### Guidelines

- [Map Symbols](#)
- [Orienteering Techniques](#)

### Techniques

- [Civilian Orienteering](#)

### The Skills:

- [Maps and Symbols](#)
- [Grids](#)
- [Scale and Distance](#)

- [Direction](#)
- [Overlays](#)
- [Aerial Photographs](#)
- [Navigation](#)

### Equipment and Methods

- [Elevation and Relief](#)
- [Terrain Association](#)
- [Navigation in Different Types of Terrain](#)

### Different Types of Terrain

- [Field Sketching](#)
- [Map Folding](#)

### Techniques

- [Units of Measure and Conversion Factors](#)

A graphic scale is a ruler printed on the map and is used to convert distances on the map to actual ground distances. The graphic scale is divided into two parts. To the right of the zero, the scale is marked in full units of measure and is called the primary scale. To the left of the zero, the scale is divided into tenths and is called the extension scale. Most maps have three or more graphic scales, each using a different unit of measure (Figure 5-2). When using the graphic scale, be sure to use the correct scale for the unit of measure desired.

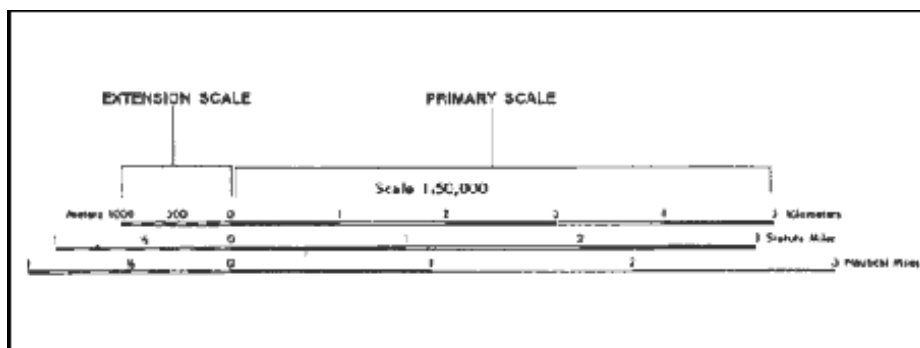
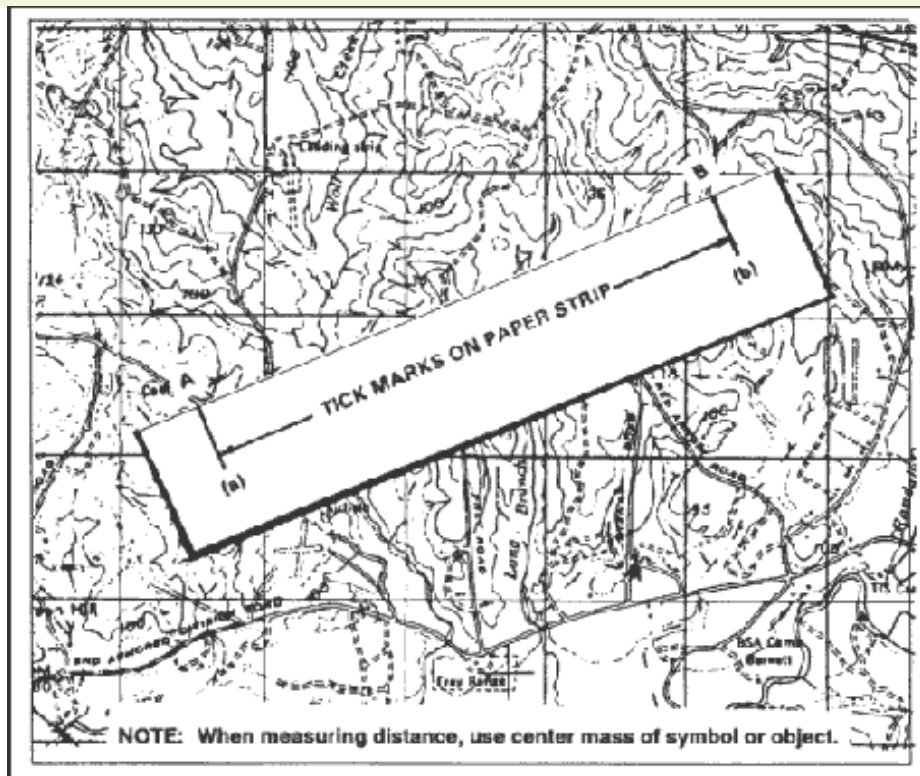


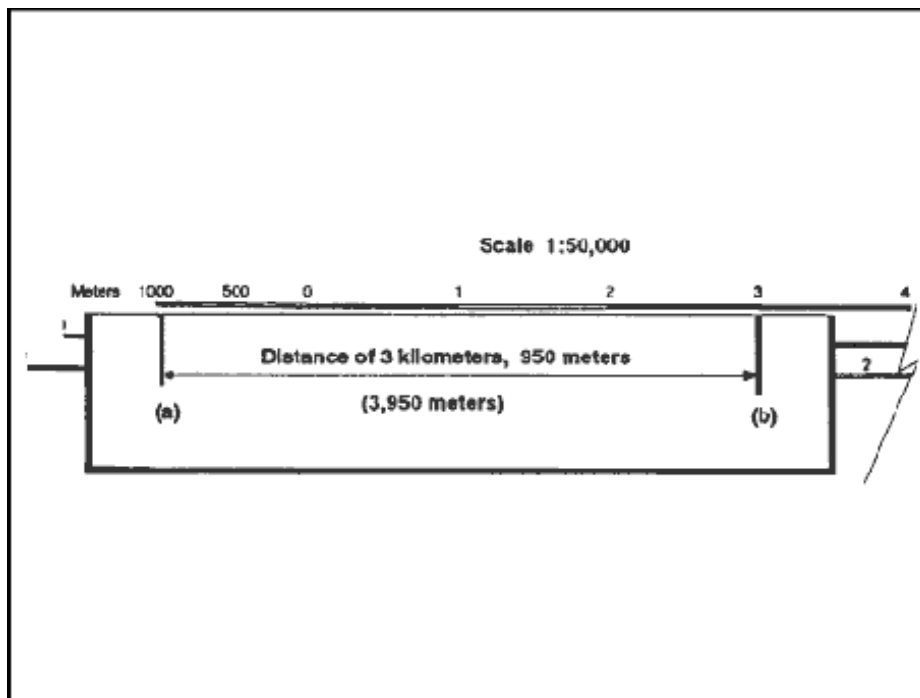
Figure 5-2. Using a graphic (bar) scale.

- To determine straight-line distance between two points on a map, lay a straight-edged piece of paper on the map so that the edge of the paper touches both points and extends past them. Make a tick mark on the edge of the paper at each point (Figure 5-3).



**Figure 5-3. Transferring map distance to paper strip.**

b. To convert the map distance to ground distance, move the paper down to the graphic bar scale, and align the right tick mark (b) with a printed number in the primary scale so that the left tick mark (a) is in the extension scale (Figure 5-4).



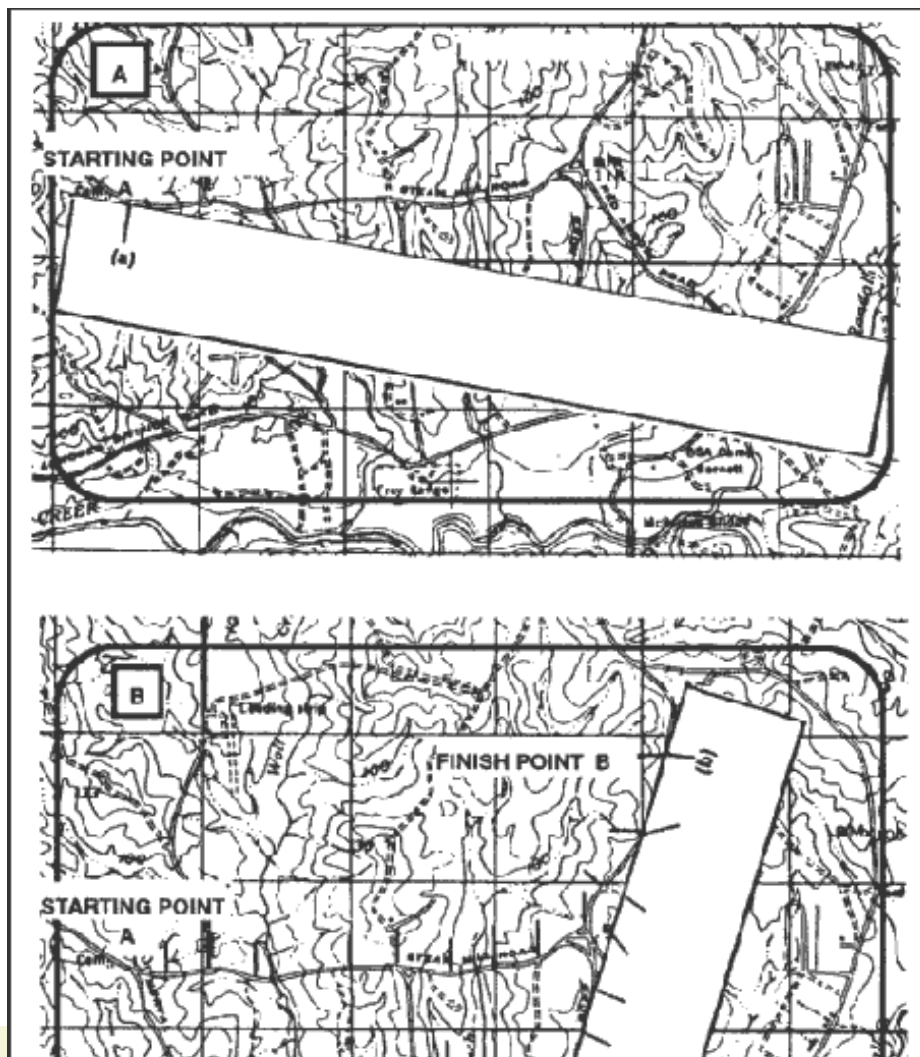
**Figure 5-4. Measuring straight-line map distance.**

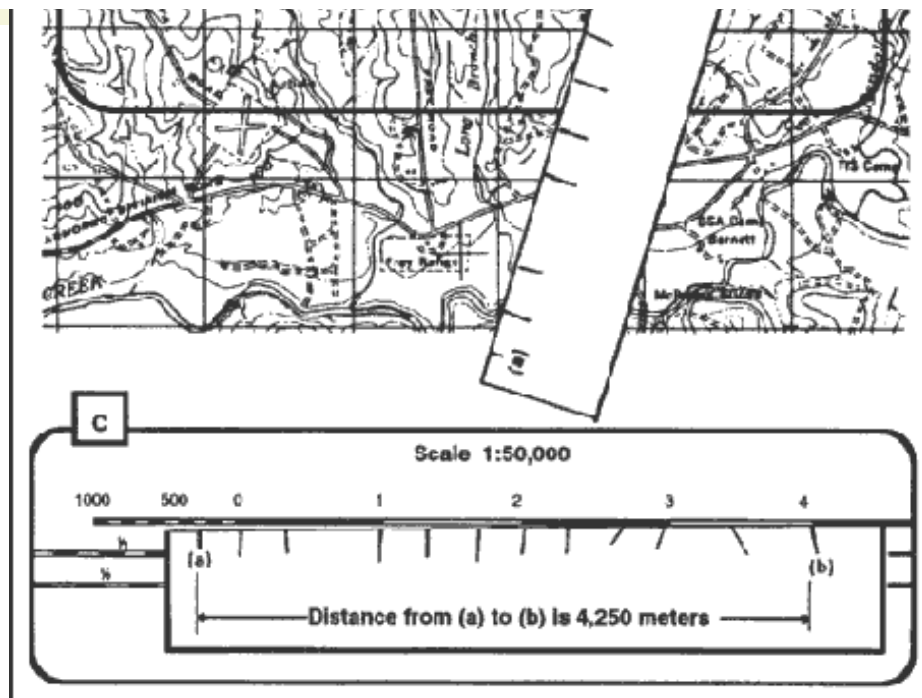
c. The right tick mark (b) is aligned with the 3,000-meter mark in the primary scale, thus the distance is at least 3,000 meters. To determine the

distance between the two points to the nearest 10 meters, look at the extension scale. The extension scale is numbered with zero at the right and increases to the left. When using the extension scale, always read right to left (Figure 5-4). From the zero left to the beginning of the first shaded area is 100 meters. From the beginning of the shaded square to the end of the shaded square is 100 to 200 meters. From the end of the first shaded square to the beginning of the second shaded square is 200 to 300 meters. Remember, the distance in the extension scale increases from right to left.

d. To determine the distance from the zero to tick mark (a), divide the distance inside the squares into tenths (Figure 5-4). As you break down the distance between the squares in the extension scale into tenths, you will see that tick mark (a) is aligned with the 950-meter mark. Adding the distance of 3,000 meters determined in the primary scale to the 950 meters you determined by using the extension scale, we find that the total distance between points (a) and (b) is 3,950 meters.

e. To measure distance along a road, stream, or other curved line, the straight edge of a piece of paper is used. In order to avoid confusion concerning the point to begin measuring from and the ending point, an eight-digit coordinate should be given for both the starting and ending points. Place a tick mark on the paper and map at the beginning point from which the curved line is to be measured. Align the edge of the paper along a straight portion and make a tick mark on both map and paper when the edge of the paper leaves the straight portion of the line being measured (Figure 5-5A).



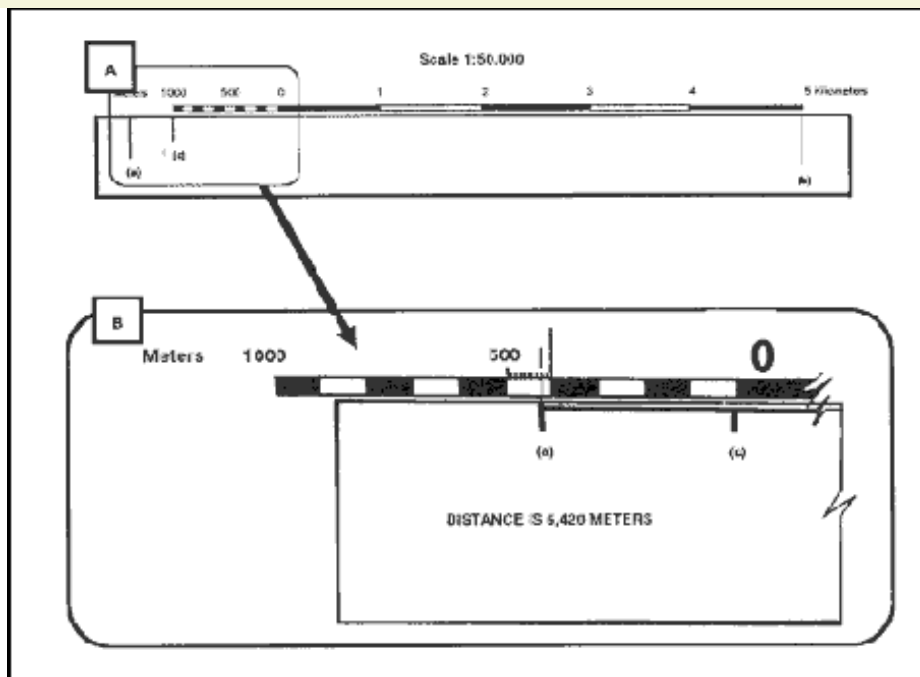


**Figure 5-5. Measuring a curved line.**

- f. Keeping both tick marks together (on paper and map), place the point of the pencil close to the edge of the paper on the tick mark to hold it in place and pivot the paper until another straight portion of the curved line is aligned with the edge of the paper. Continue in this manner until the measurement is completed (Figure 5-5B).
- g. When you have completed measuring the distance, move the paper to the graphic scale to determine the ground distance. The only tick marks you will be measuring the distance between are tick marks (a) and (b). The tick marks in between are not used (Figure 5-5C).
- h. There may be times when the distance you measure on the edge of the paper exceeds the graphic scale. In this case, there are different techniques you can use to determine the distance.

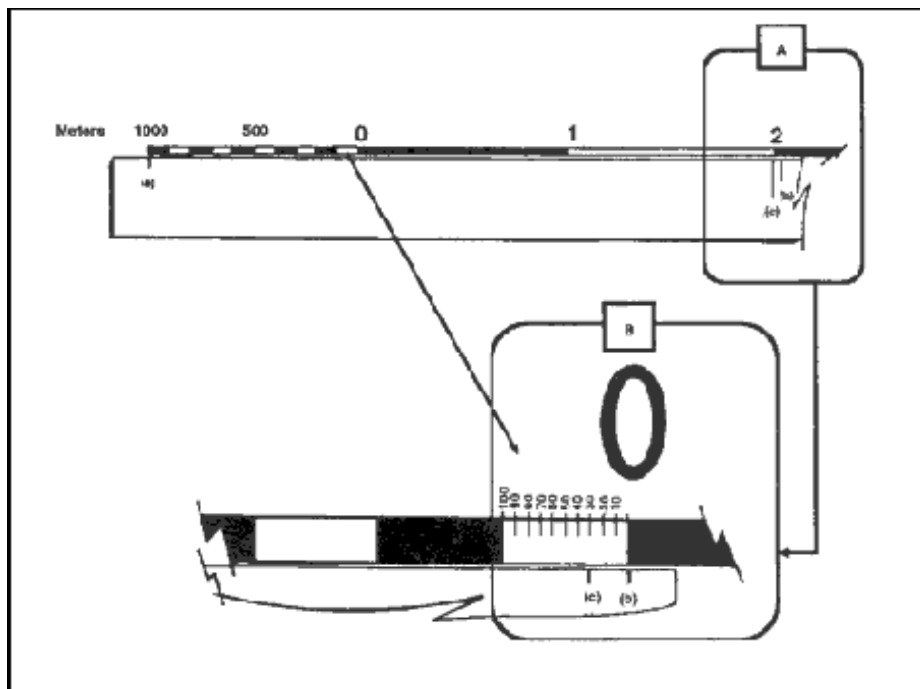
(1) One technique is to align the right tick mark (b) with a printed number in the primary scale, in this case the 5. You can see that from point (a) to point (b) is more than 6,000 meters when you add the 1,000 meters in the extension scale. To determine the exact distance to the nearest 10 meters, place a tick mark (c) on the edge of the paper at the end of the extension scale (Figure 5-6A). You know that from point (b) to point (c) is 6,000 meters. With the tick mark (c) placed on the edge of the paper at the end of the extension scale, slide the paper to the right. Remember the distance in the extension is always read from right to left. Align tick mark (c) with zero and then measure the distance between tick marks (a) and (c). The distance between tick marks (a) and (c) is 420 meters. The total ground distance between start and finish points is 6,420 meters (Figure 5-6B).





**Figure 5-6. Determining the exact distance.**

(2) Another technique that may be used to determine exact distance between two points when the edge of the paper exceeds the bar scale is to slide the edge of the paper to the right until tick mark (a) is aligned with the edge of the extension scale. Make a tick mark on the paper, in line with the 2,000-meter mark (c) (Figure 5-7A). Then slide the edge of the paper to the left until tick mark (b) is aligned with the zero. Estimate the 100-meter increments into 10-meter increments to determine how many meters tick mark (c) is from the zero line (Figure 5-7B). The total distance would be 3,030 meters.



**Figure 5-7. Reading the extension scale.**

(3) At times you may want to know the distance from a point on the map to a point off the map. In order to do this, measure the distance from the start point to the edge of the map. The marginal notes give the road distance from the edge of the map to some towns, highways, or junctions off the map. To determine the total distance, add the distance measured on the map to the distance given in the marginal notes. Be sure the unit of measure is the same.

(4) When measuring distance in statute or nautical miles, round it off to the nearest one-tenth of a mile and make sure the appropriate bar scale is used.

(5) Distance measured on a map does not take into consideration the rise and fall of the land. All distances measured by using the map and graphic scales are flat distances. Therefore, the distance measured on a map will increase when actually measured on the ground. This must be taken into consideration when navigating across country.

i. The amount of time required to travel a certain distance on the ground is an important factor in most military operations. This can be determined if a map of the area is available and a graphic time-distance scale is constructed for use with the map as follows:

***R = Rate of travel (speed)***

***T = Time***

***D = Distance (ground distance)***

$$T = \frac{D}{R}$$

For example, if an infantry unit is marching at an average rate (R) of 4 kilometers per hour, it will take about 3 hours (T) to travel 12 kilometers.

***12 (D)***

$$\frac{\text{---}}{4 (R)} = \text{---} 3 (T)$$

j. To construct a time-distance scale (Figure 5-8A), knowing your length of march, rate of speed, and map scale, that is, 12 kilometers at 3 kilometers per hour on a 1:50,000-scale map, use the following process:

(1) Mark off the total distance on a line by referring to the graphic scale of the map or, if this is impracticable, compute the length of the line as follows:

(a) Convert the ground distance to centimeters:  
 12 kilometers x 100,000 (centimeters per kilometer) =  
 1,200,000 centimeters.

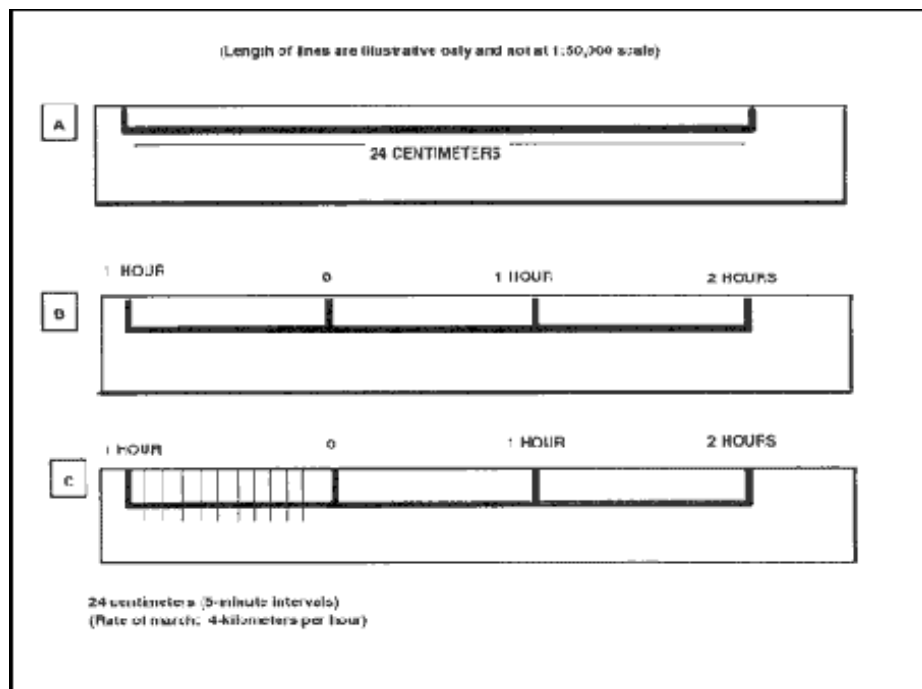
(b) Find the length of the line to represent the distance at map scale—

$$MD = \frac{1}{\text{---}} = \frac{1,200,000}{\text{---}} = 24 \text{ centimeters}$$

50,000

50,000

(c) Construct a line 24 centimeters in length (Figure 5-8A).



**Figure 5-8. Constructing a time-distance scale.**

(2) Divide the line by the rate of march into three parts (Figure 5-8B), each part representing the distance traveled in one hour, and label.

(3) Divide the scale extension (left portion) into the desired number of lesser time divisions—

**1-minute divisions — 60**

**5-minute divisions — 12**

**10-minute divisions — 6**

(4) Figure 5-8C shows a 5-minute interval scale. Make these divisions in the same manner as for a graphic scale. The completed scale makes it possible to determine where the unit will be at any given time. However, it must be remembered that this scale is for one specific rate of march only, 4 kilometers per hour.

**Back to Scale and Distance**

Check out the **Amazon Coupons** before you buy.

Copyright © 2001-2002 Jalic LLC. All Rights Reserved.

[Disclaimer](#) | [Privacy Policy](#) | [Contact Us](#)



[Orienteering Home](#)

## Other Methods

### The Sport:

- [Orienteering History](#)
- [Orienteering Overview](#)

### Overview

- [Course Setup](#)
- [Officials](#)
- [Start/Finish Areas](#)
- [Course Safety](#)
- [Control Point](#)

### Guidelines

- [Map Symbols](#)
- [Orienteering Techniques](#)

### Techniques

- [Civilian Orienteering](#)

### The Skills:

- [Maps and Symbols](#)
- [Marginal Information](#)

- [Grids](#)
- [Scale and Distance](#)
- [Direction](#)
- [Overlays](#)

- [Aerial Photographs](#)
- [Navigation](#)

### Equipment and Methods

- [Elevation and Relief](#)
- [Terrain Association](#)
- [Navigation in Different Types of Terrain](#)

### Different Types of Terrain

- [Field Sketching](#)
- [Map Folding](#)

### Techniques

- [Units of Measure and Conversion Factors](#)

Determining distance is the most common source of error encountered while moving either mounted or dismounted. There may be circumstances where you are unable to determine distance using your map or where you are without a map. It is therefore essential to learn methods by which you can accurately pace, measure, use subtense, or estimate distances on the ground.

a. **Pace Count.** Another way to measure ground distance is the pace count. A pace is equal to one natural step, about 30 inches long. To accurately use the pace count method, you must know how many paces it takes you to walk 100 meters. To determine this, you must walk an accurately measured course and count the number of paces you take. A pace course can be as short as 100 meters or as long as 600 meters. The pace course, regardless of length, must be on similar terrain to that you will be walking over. It does no good to walk a course on flat terrain and then try to use that pace count on hilly terrain. To determine your pace count on a 600-meter course, count the paces it takes you to walk the 600 meters, then divide the total paces by 6. The answer will give you the average paces it takes you to walk 100 meters. It is important that each person who navigates while dismounted knows his pace count.

(1) There are many methods to keep track of the distance traveled when using the pace count. Some of these methods are: put a pebble in your pocket every time you have walked 100 meters according to your pace count; tie knots in a string; or put marks in a notebook. Do not try to remember the count; always use one of these methods or design your own method.

(2) Certain conditions affect your pace count in the field, and you must allow for them by making adjustments.

(a) *Slopes.* Your pace lengthens on a downslope and shortens on an upgrade. Keeping this in mind, if it normally takes you 120 paces to walk 100 meters, your pace count may increase to 130 or more when walking up a slope.

(b) *Winds.* A head wind shortens the pace and a tail wind increases it.

(c) *Surfaces.* Sand, gravel, mud, snow, and similar surface materials tend to shorten the pace.

(d) *Elements*. Falling snow, rain, or ice cause the pace to be reduced in length.

(e) *Clothing*. Excess clothing and boots with poor traction affect the pace length.

(f) *Visibility*. Poor visibility, such as in fog, rain, or darkness, will shorten your pace.

b. **Odometer**. Distances can be measured by an odometer, which is standard equipment on most vehicles. Readings are recorded at the start and end of a course and the difference is the length of the course.

(1) To convert kilometers to miles, multiply the number of kilometers by 0.62.

**EXAMPLE:**

$$16 \text{ kilometers} = 16 \times 0.62 = 9.92 \text{ miles}$$

(2) To convert miles to kilometers, divided the number of miles by 0.62.

**EXAMPLE:**

$$10 \text{ miles} = 10 \text{ divided by } 0.62 = 16.12 \text{ kilometers}$$

c. **Subtense**. The subtense method is a fast method of determining distance and yields accuracy equivalent to that obtained by measuring distance with a premeasured piece of wire. An advantage is that a horizontal distance is obtained indirectly; that is, the distance is computed rather than measured. This allows subtense to be used over terrain where obstacles such as streams, ravines, or steep slopes may prohibit other methods of determining distance.

(1) The principle used in determining distance by the subtense method is similar to that used in estimating distance by the mil relation formula. The field artillery application of the mil relation formula involves only estimations. It is not accurate enough for survey purposes. However, the subtense method uses precise values with a trigonometric solution. Subtense is based on a principle of visual perspective—the farther away an object, the smaller it appears.

(2) The following two procedures are involved in subtense measurement:

- Establishing a base of known length.
- Measuring the angle of that base by use of the aiming circle.

(3) The subtense base may be any desired length. However, if a 60-meter base, a 2-meter bar, or the length of an M16A1 or M16A2 rifle is used, precomputed subtense tables are available. The M16 or 2-meter bar must be held horizontal and perpendicular to the line

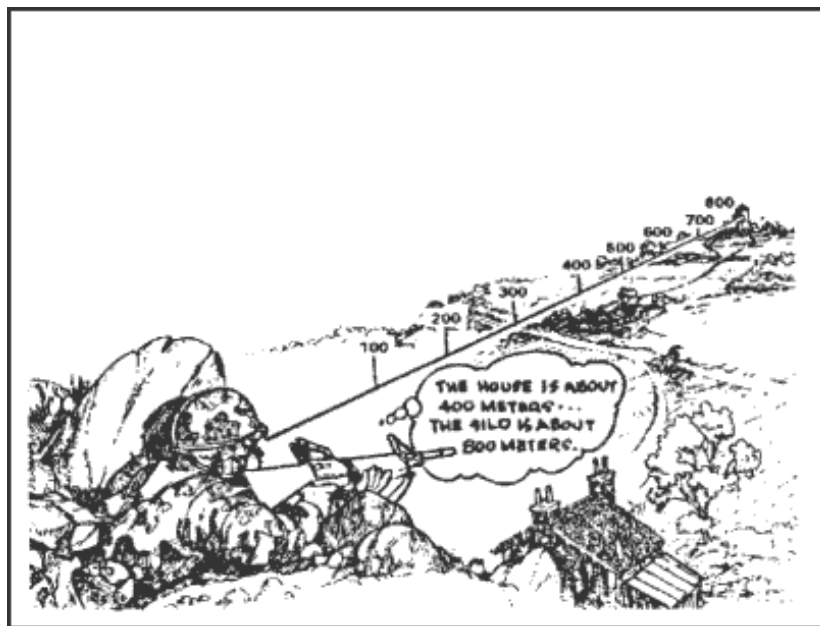


of sight by a soldier facing the aiming circle. The instrument operator sights on one end of the M16 or 2-meter bar and measures the horizontal clockwise angle to the other end of the rifle or bar. He does this twice and averages the angles. He then enters the appropriate subtense table with the mean angle and extracts the distance. Accurate distances can be obtained with the M16 out to approximately 150 meters, with the 2-meter bar out to 250 meters, and with the 60-meter base out to 1,000 meters. If a base of another length is desired, a distance can be computed by using the following formula:

$$\text{Distance} = \frac{1/2 \text{ (base in meters)}}{\text{Tan } (1/2) \text{ (in mils)}}$$

d. **Estimation.** At times, because of the tactical situation, it may be necessary to estimate range. There are two methods that may be used to estimate range or distance.

(1) **100-Meter Unit-of-Measure Method.** To use this method, the soldier must be able to visualize a distance of 100 meters on the ground. For ranges up to 500 meters, he determines the number of 100-meter increments between the two objects he wishes to measure. Beyond 500 meters, the soldier must select a point halfway to the object(s) and determine the number of 100-meter increments to the halfway point, then double it to find the range to the object(s) (Figure 5-9).



**Figure 5-9. Using a 100-meter unit-of-measure method.**

(2) **Flash-To-Bang Method.** To use this method to determine range to an explosion or enemy fire, begin to count when you see the flash. Count the seconds until you hear the weapon fire. This time interval may be measured with a stopwatch or by using a steady count, such as one-thousand-one, one-thousand-two, and so forth, for a three-second estimated count. If you must count higher

than 10 seconds, start over with one. Multiply the number of seconds by 330 meters to get the approximate range (FA uses 350 meters instead).

(3) **Proficiency of Methods.** The methods discussed above are used only to estimate range (Table 5-1). Proficiency in both methods requires constant practice. The best training technique is to require the soldier to pace the range after he has estimated the distance. In this way, the soldier discovers the actual range for himself, which makes a greater impression than if he is simply told the correct range.

Factors Affecting Range Estimation	Factors Causing Underestimation of Range	Factors Causing Overestimation of Range
The clearness of outline and details of the object.	When most of the object is visible and offers a clear outline.	When only a small part of the object can be seen or the object is small in relation to its surroundings.
Nature of terrain or position of the observer.	When looking across a depression that is mostly hidden from view.  When looking downward from high ground.  When looking down a straight, open road or along a railroad.  When looking over uniform surfaces like water, snow, desert, or grain fields.  In bright light or when the sun is shining from behind the observer.	When looking across a depression that is totally visible.  When vision is confined, as in streets, draws, or forest trails.  When looking from low ground toward high ground.  In poor light, such as dawn and dusk; in rain, snow, fog; or when the sun is in the observer's eyes.
Light and atmosphere	When the object is in sharp contrast with the background or is silhouetted because of its size, shape, or color.  When seen in the clear air of high altitudes.	When object blends into the background or terrain.

**Table 5-1. Factors of range estimation.**

[Back to Scale and Distance](#)

Check out the **Amazon Coupons** before you buy.

Copyright © 2001-2002 Jalic LLC. All Rights Reserved.

**[Disclaimer](#) | [Privacy Policy](#) | [Contact Us](#)**



[Orienteering Home](#)

## Methods of Expressing Direction

### The Sport:

- [Orienteering History](#)
- [Orienteering](#)

### Overview

- [Course Setup](#)
- [Officials](#)
- [Start/Finish Areas](#)
- [Course Safety](#)
- [Control Point](#)

### Guidelines

- [Map Symbols](#)
- [Orienteering](#)

### Techniques

- [Civilian Orienteering](#)

### The Skills:

- [Maps](#)
- [Marginal Information and Symbols](#)
- [Grids](#)
- [Scale and Distance](#)
- [Direction](#)
- [Overlays](#)
- [Aerial Photographs](#)
- [Navigation](#)

### Equipment and

### Methods

- [Elevation and Relief](#)
- [Terrain Association](#)
- [Navigation in](#)

### Different Types of

### Terrain

- [Field Sketching](#)
- [Map Folding](#)

### Techniques

- [Units of Measure and Conversion Factors](#)

Military personnel need a way of expressing direction that is accurate, is adaptable to any part of the world, and has a common unit of measure. Directions are expressed as units of angular measure.

- a. **Degree.** The most common unit of measure is the degree ( $^{\circ}$ ) with its subdivisions of minutes ( $'$ ) and seconds ( $''$ ).

**1 degree = 60 minutes.**

**1 minute = 60 seconds.**

- b. **Mil.** Another unit of measure, the mil (abbreviated  $m$ ), is used mainly in artillery, tank, and mortar gunnery. The mil expresses the size of an angle formed when a circle is divided into 6,400 angles, with the vertex of the angles at the center of the circle. A relationship can be established between degrees and mils. A circle equals 6400 mils divided by 360 degrees, or 17.78 mils per degree. To convert degrees to mils, multiply degrees by 17.78.

- c. **Grad.** The grad is a metric unit of measure found on some foreign maps. There are 400 grads in a circle (a 90-degree right angle equals 100 grads). The grad is divided into 100 centesimal minutes (centigrads) and the minute into 100 centesimal seconds (milligrads).

[Back to Direction](#)

Check out the [Amazon Coupons](#) before you buy.

Copyright © 2001-2002 Jalic LLC. All Rights Reserved.

[Disclaimer](#) | [Privacy Policy](#) | [Contact Us](#)





[Orienteering Home](#)

The Sport:

- [Orienteering History](#)
- [Orienteering](#)

Overview

- [Course Setup](#)
- [Officials](#)
- [Start/Finish Areas](#)
- [Course Safety](#)
- [Control Point](#)

Guidelines

- [Map Symbols](#)
- [Orienteering](#)

Techniques

- [Civilian Orienteering](#)

The Skills:

- [Maps](#)
- [Marginal Information and Symbols](#)
- [Grids](#)
- [Scale and Distance](#)
- [Direction](#)
- [Overlays](#)
- [Aerial Photographs](#)
- [Navigation](#)

Equipment and

Methods

- [Elevation and Relief](#)
- [Terrain Association](#)
- [Navigation in](#)

Different Types of Terrain

- [Field Sketching](#)
- [Map Folding](#)

Techniques

- [Units of Measure and Conversion Factors](#)

## Base Lines

In order to measure something, there must always be a starting point or zero measurement. To express direction as a unit of angular measure, there must be a starting point or zero measure and a point of reference. These two points designate the base or reference line. There are three base lines—true north, magnetic north, and grid north. The most commonly used are magnetic and grid.

- a. **True North.** A line from any point on the earth's surface to the north pole. All lines of longitude are true north lines. True north is usually represented by a star (Figure 6-1).

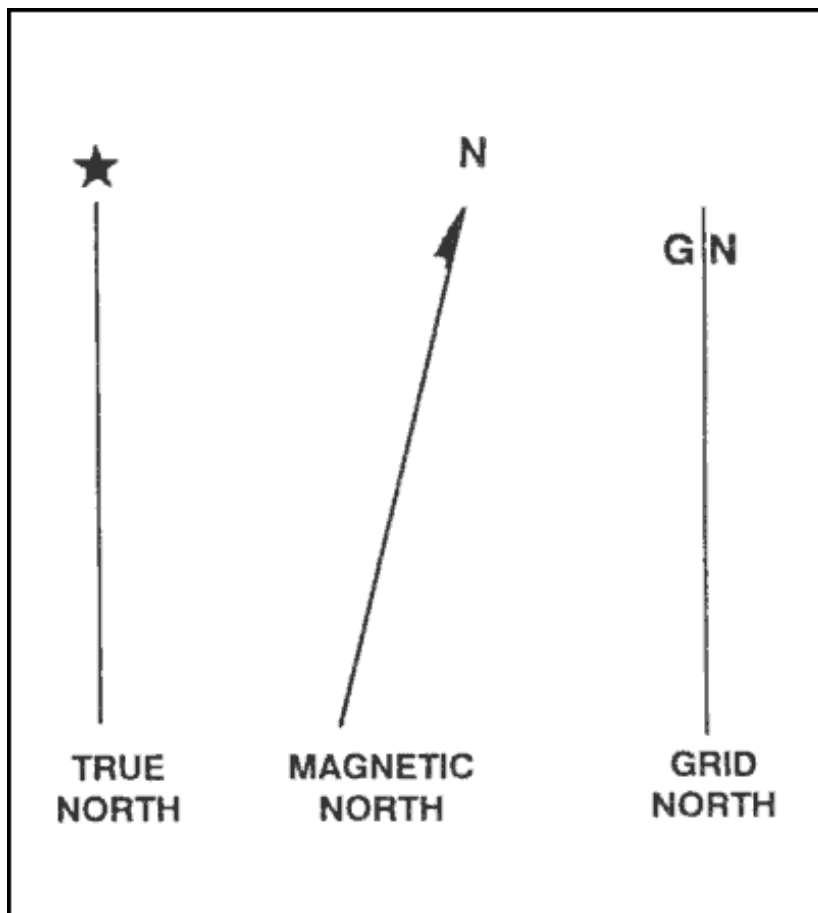


Figure 6-1. Three norths.



b. **Magnetic North.** The direction to the north magnetic pole, as indicated by the north-seeking needle of a magnetic instrument. The magnetic north is usually symbolized by a line ending with half of an arrowhead (Figure 6-1). Magnetic readings are obtained with magnetic instruments, such as lensatic and M2 compasses.

c. **Grid North.** The north that is established by using the vertical grid lines on the map. Grid north may be symbolized by the letters GN or the letter "y" (Figure 6-1).

[Back to Direction](#)

Check out the [Amazon Coupons](#) before you buy.

Copyright © 2001-2002 Jalic LLC. All Rights Reserved.

[Disclaimer](#) | [Privacy Policy](#) | [Contact Us](#)

# Orienteering

## Orienteering Home

### The Sport:

- Orienteering History
- Orienteering

### Overview

- Course Setup
- Officials
- Start/Finish Areas
- Course Safety
- Control Point

### Guidelines

- Map Symbols
- Orienteering

### Techniques

- Civilian Orienteering

### The Skills:

- Maps
- Marginal Information and Symbols
- Grids
- Scale and Distance
- Direction
- Overlays
- Aerial Photographs
- Navigation

### Equipment and

### Methods

- Elevation and Relief
- Terrain Association
- Navigation in

### Different Types of Terrain

- Field Sketching
- Map Folding

### Techniques

- Units of Measure and Conversion Factors

## Azimuths

An azimuth is defined as a horizontal angle measured clockwise from a north base line. This north base line could be true north, magnetic north, or grid north. The azimuth is the most common military method to express direction. When using an azimuth, the point from which the azimuth originates is the center of an imaginary circle (Figure 6-2). This circle is divided into 360 degrees or 6400 mils.

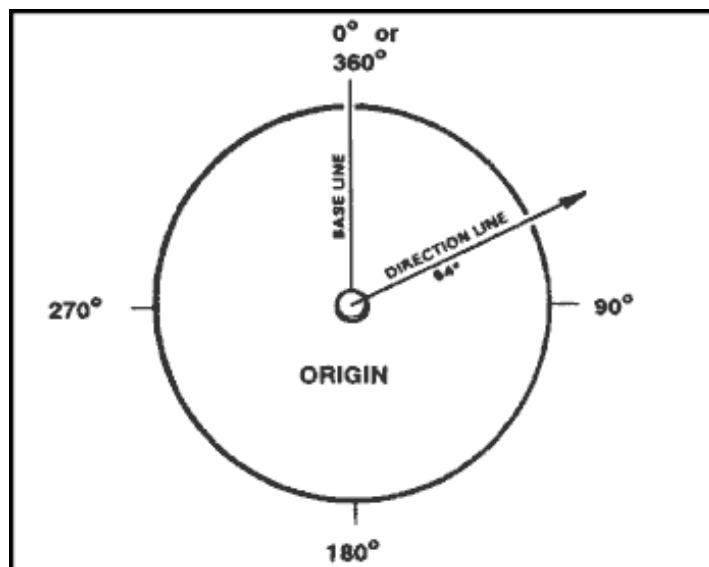


Figure 6-2. Origin of azimuth circle.

- a. **Back Azimuth.** A back azimuth is the opposite direction of an azimuth. It is comparable to doing "about face." To obtain a back azimuth from an azimuth, add 180 degrees if the azimuth is 180 degrees or less, or subtract 180 degrees if the azimuth is 180 degrees or more (Figure 6-3). The back azimuth of 180 degrees may be stated as 0 degrees or 360 degrees. For mils, if the azimuth is less than 3200 mils, add 3200 mils, if the azimuth is more than 3200 mils, subtract 3200 mils.

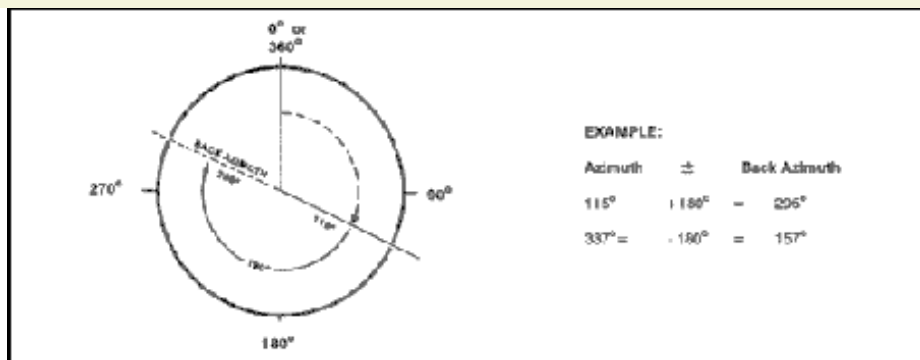


Figure 6-3. Back azimuth.

**WARNING**

**When converting azimuths into back azimuths, extreme care should be exercised when adding or subtracting the 180 degrees. A simple mathematical mistake could cause disastrous consequences.**

- b. **Magnetic Azimuth.** The magnetic azimuth is determined by using magnetic instruments, such as lensatic and M2 compasses. Refer to Chapter 9, paragraph 4, for details.
- c. **Field-Expedient Methods.** Several field-expedient methods to determine direction are discussed [here](#).

[Back to Direction](#)

Check out the **Amazon Coupons** before you buy.

Copyright © 2001-2002 Jalic LLC. All Rights Reserved.  
**Disclaimer | Privacy Policy | Contact Us**



[Orienteering Home](#)

**The Sport:**

- [Orienteering History](#)
- [Orienteering Overview](#)

**Overview**

- [Course Setup](#)
- [Officials](#)
- [Start/Finish Areas](#)
- [Course Safety](#)
- [Control Point](#)

**Guidelines**

- [Map Symbols](#)
- [Orienteering Techniques](#)

**Techniques**

- [Civilian Orienteering](#)

**The Skills:**

- [Maps](#)
- [Marginal Information and Symbols](#)
- [Grids](#)
- [Scale and Distance](#)
- [Direction](#)
- [Overlays](#)
- [Aerial Photographs](#)
- [Navigation](#)

**Equipment and Methods**

- [Elevation and Relief](#)
- [Terrain Association](#)
- [Navigation in Different Types of Terrain](#)

- [Field Sketching](#)
- [Map Folding](#)

**Techniques**

- [Units of Measure and Conversion Factors](#)

## Grid Azimuths

When an azimuth is plotted on a map between point A (starting point) and point B (ending point), the points are joined together by a straight line. A protractor is used to measure the angle between grid north and the drawn line, and this measured azimuth is the grid azimuth (Figure 6-4).

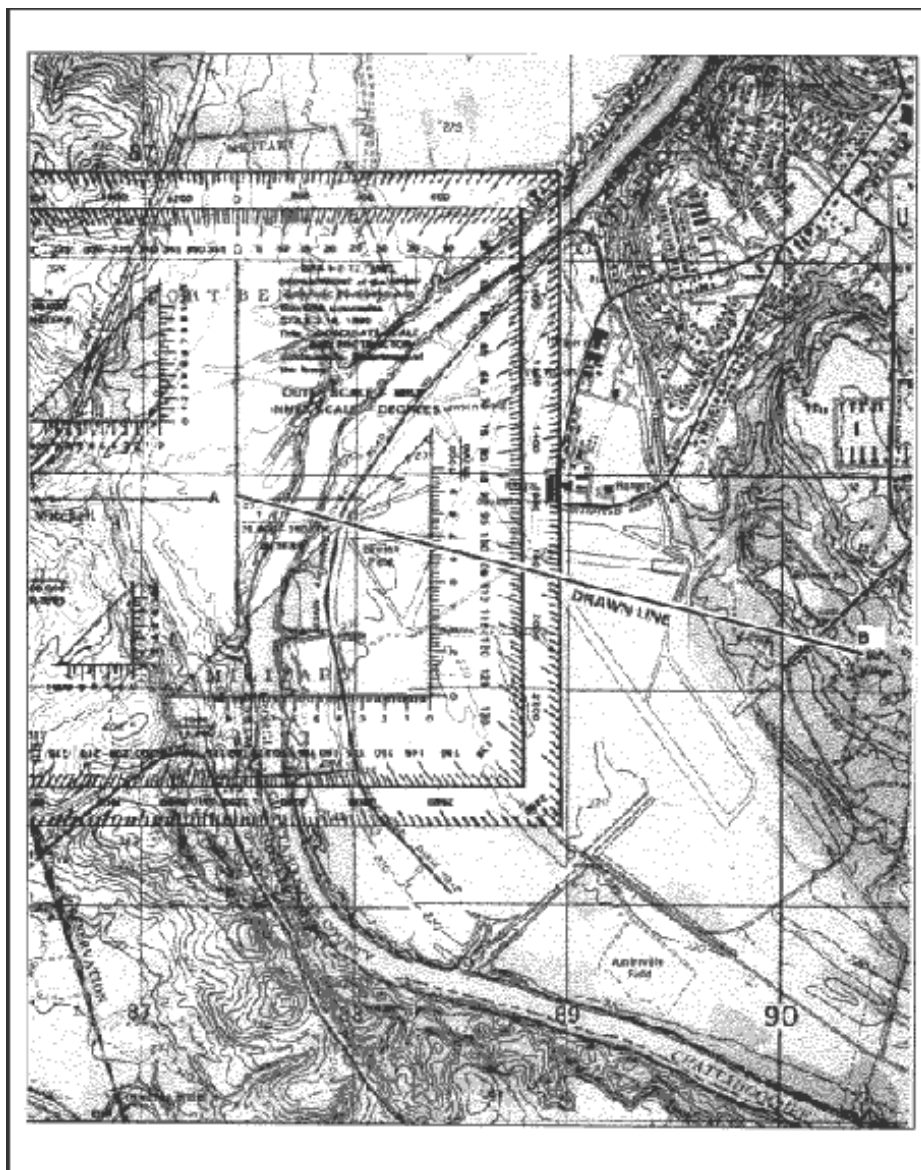


Figure 6-4. Measuring an azimuth.

**WARNING**

**When measuring azimuths on a map, remember that you are measuring from a starting point to an ending point. If a mistake is made and the reading is taken from the ending point, the grid azimuth will be opposite, thus causing the user to go in the wrong direction.**

[Back to Direction](#)

Check out the **Amazon Coupons** before you buy.

Copyright © 2001-2002 Jalic LLC. All Rights Reserved.

**[Disclaimer](#) | [Privacy Policy](#) | [Contact Us](#)**





[Orienteering Home](#)

**The Sport:**

- [Orienteering History](#)
- [Orienteering Overview](#)
- [Course Setup](#)
- [Officials](#)
- [Start/Finish Areas](#)
- [Course Safety](#)
- [Control Point Guidelines](#)
- [Map Symbols](#)
- [Orienteering Techniques](#)
- [Civilian Orienteering](#)

**The Skills:**

- [Maps](#)
- [Marginal Information and Symbols](#)
- [Grids](#)
- [Scale and Distance](#)
- [Direction](#)
- [Overlays](#)
- [Aerial Photographs](#)
- [Navigation](#)
- [Equipment and Methods](#)
- [Elevation and Relief](#)
- [Terrain Association](#)
- [Navigation in Different Types of Terrain](#)

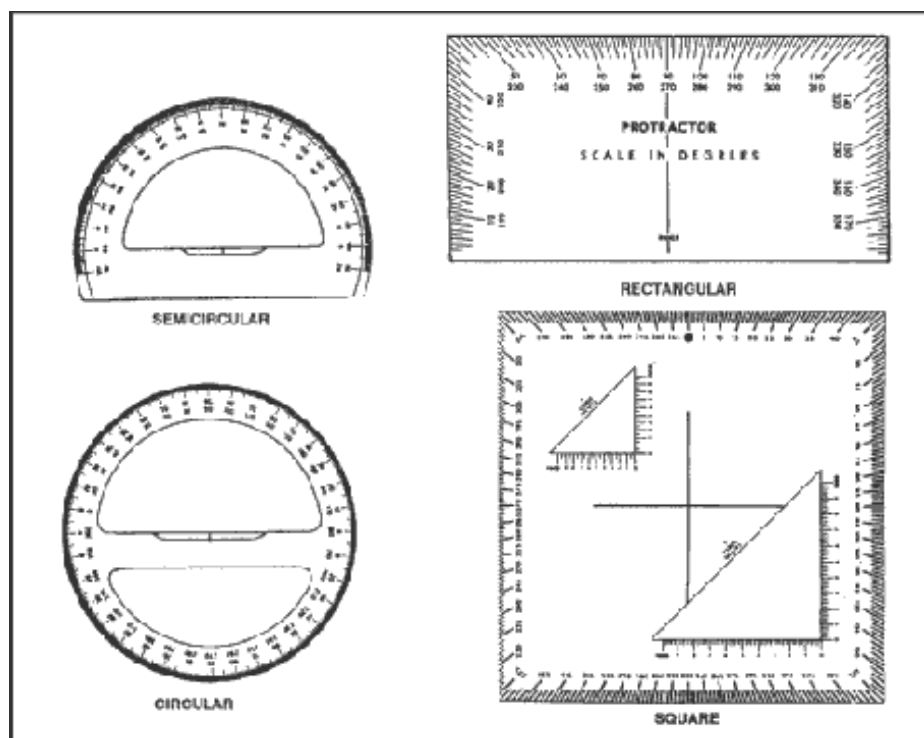
- [Field Sketching](#)
- [Map Folding](#)

**Techniques**

- [Units of Measure and Conversion Factors](#)

## Protractors

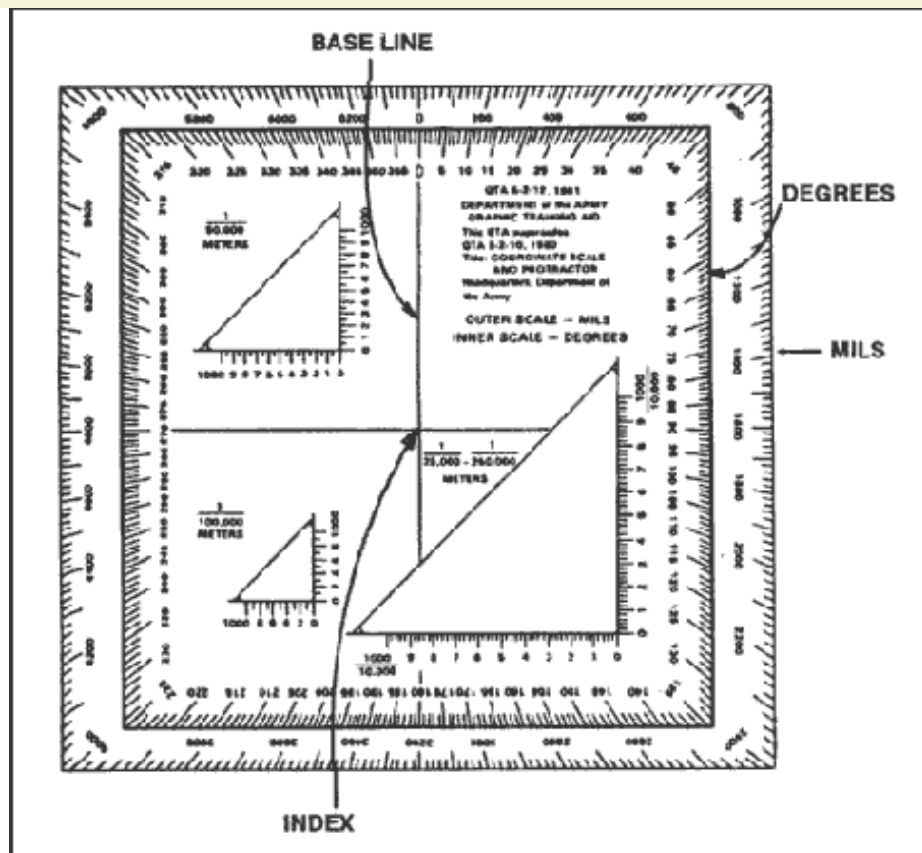
There are several types of protractors—full circle, half circle, square, and rectangular (Figure 6-5). All of them divide the circle into units of angular measure, and each has a scale around the outer edge and an index mark. The index mark is the center of the protractor circle from which all directions are measured.



**Figure 6-5. Types of protractors.**

a. The military protractor, GTA 5-2-12, contains two scales: one in degrees (inner scale) and one in mils (outer scale). This protractor represents the azimuth circle. The degree scale is graduated from 0 to 360 degrees; each tick mark on the degree scale represents one degree. A line from 0 to 180 degrees is called the base line of the protractor. Where the base line intersects the horizontal line, between 90 and 270 degrees, is the index or center of the protractor (Figure 6-6).





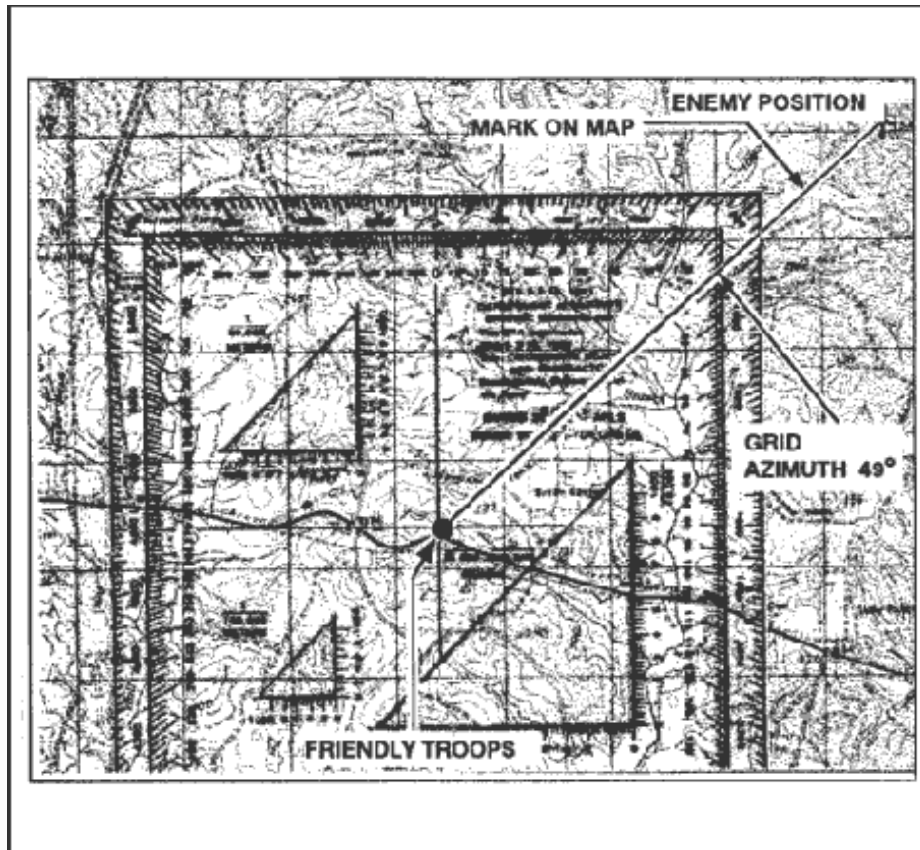
**Figure 6-6. Military protractor.**

b. When using the protractor, the base line is always oriented parallel to a north-south grid line. The 0- or 360-degree mark is always toward the top or north on the map and the 90° mark is to the right.

- (1) To determine the grid azimuth—
  - (a) Draw a line connecting the two points (A and B).
  - (b) Place the index of the protractor at the point where the drawn line crosses a vertical (north-south) grid line.
  - (c) Keeping the index at this point, align the 0- to 180-degree line of the protractor on the vertical grid line.
  - (d) Read the value of the angle from the scale; this is the grid azimuth from point A to point B (Figure 6-4).
- (2) To plot an azimuth from a known point on a map (Figure 6-7)—
  - (a) Convert the azimuth from magnetic to grid, if necessary.
  - (b) Place the protractor on the map with the index mark at the center of mass of the known point and the base line parallel to a north-south grid line.

- (c) Make a mark on the map at the desired azimuth.
- (d) Remove the protractor and draw a line connecting the known point and the mark on the map. This is the grid direction line (azimuth).

**NOTE:** When measuring an azimuth, the reading is always to the nearest degree or 10 mils. Distance does not change an accurately measured azimuth.



**Figure 6-7. Plotting an azimuth on the map.**

c. To obtain an accurate reading with the protractor (to the nearest degree or 10 mils), there are two techniques to check that the base line of the protractor is parallel to a north-south grid line.

- (1) Place the protractor index where the azimuth line cuts a north-south grid line, aligning the base line of the protractor directly over the intersection of the azimuth line with the north-south grid line. The user should be able to determine whether the initial azimuth reading was correct.
- (2) The user should re-read the azimuth between the azimuth and north-south grid line to check the initial azimuth.
- (3) Note that the protractor is cut at both the top and bottom by the same north-south grid line. Count the number of degrees from the 0-degree mark at the top of the protractor to this north-south grid line and then count the number of degrees from the 180-degree mark at the bottom of the protractor to this same grid line.

If the two counts are equal, the protractor is properly aligned.

[Back to Direction](#)

Check out the [Amazon Coupons](#) before you buy.

Copyright © 2001-2002 Jalic LLC. All Rights Reserved.

[Disclaimer](#) | [Privacy Policy](#) | [Contact Us](#)



Orienteering Home

The Sport:

- Orienteering History
- Orienteering Overview
- Course Setup
- Officials
- Start/Finish Areas
- Course Safety
- Control Point
- Guidelines
- Map Symbols
- Orienteering Techniques
- Civilian Orienteering

The Skills:

- Maps
- Marginal Information and Symbols
- Grids
- Scale and Distance
- Direction
- Overlays
- Aerial Photographs
- Navigation
- Equipment and Methods
- Elevation and Relief
- Terrain Association
- Navigation in Different Types of Terrain
- Field Sketching
- Map Folding
- Techniques
- Units of Measure and Conversion Factors

## Declination

Declination is the angular difference between any two norths. If you have a map and a compass, the one of most interest to you will be between magnetic and grid north. The declination diagram (Figure 6-8) shows the angular relationship, represented by prongs, among grid, magnetic, and true norths. While the relative positions of the prongs are correct, they are seldom plotted to scale. Do not use the diagram to measure a numerical value. This value will be written in the map margin (in both degrees and mils) beside the diagram.

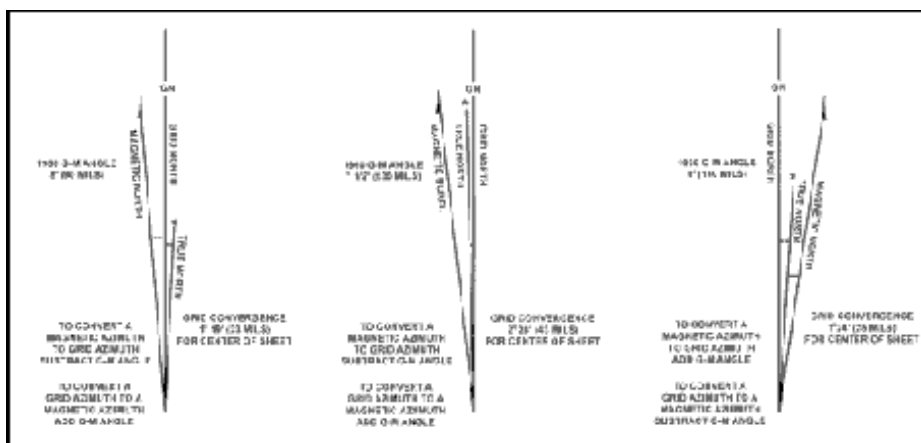


Figure 6-8. Declination diagrams.

- a. **Location.** A declination diagram is a part of the information in the lower margin on most larger maps. On medium-scale maps, the declination information is shown by a note in the map margin.
- b. **Grid-Magnetic Angle.** The G-M angle value is the angular size that exists between grid north and magnetic north. It is an arc, indicated by a dashed line, that connects the grid-north and magnetic-north prongs. This value is expressed to the nearest 1/2 degree, with mil equivalents shown to the nearest 10 mils. The G-M angle is important to the map reader/land navigator because azimuths translated between map and ground will be in error by the size of the declination angle if not adjusted for it.
- c. **Grid Convergence.** An arc indicated by a dashed line connects the prongs for true north and grid north. The value of the angle for the center of the sheet is given to the nearest full minute with its equivalent to the nearest mil. These data are shown in the form of a grid-convergence note.

d. **Conversion.** There is an angular difference between the grid north and the magnetic north. Since the location of magnetic north does not correspond exactly with the grid-north lines on the maps, a conversion from magnetic to grid or vice versa is needed.

(1) **With Notes.** Simply refer to the conversion notes that appear in conjunction with the diagram explaining the use of the G-M angle (Figure 6-8). One note provides instructions for converting magnetic azimuth to grid azimuth; the other, for converting grid azimuth to magnetic azimuth. The conversion (add or subtract) is governed by the direction of the magnetic-north prong relative to that of the north-grid prong.

(2) **Without Notes.** In some cases, there are no declination conversion notes on the margin of the map; it is necessary to convert from one type of declination to another. A magnetic compass gives a magnetic azimuth; but in order to plot this line on a gridded map, the magnetic azimuth value must be changed to grid azimuth. The declination diagram is used for these conversions. A rule to remember when solving such problems is this: **No matter where the azimuth line points, the angle to it is always measured clockwise from the reference direction (base line).** With this in mind, the problem is solved by the following steps:

(a) Draw a vertical or grid-north line (prong). Always align this line with the vertical lines on a map (Figure 6-9).

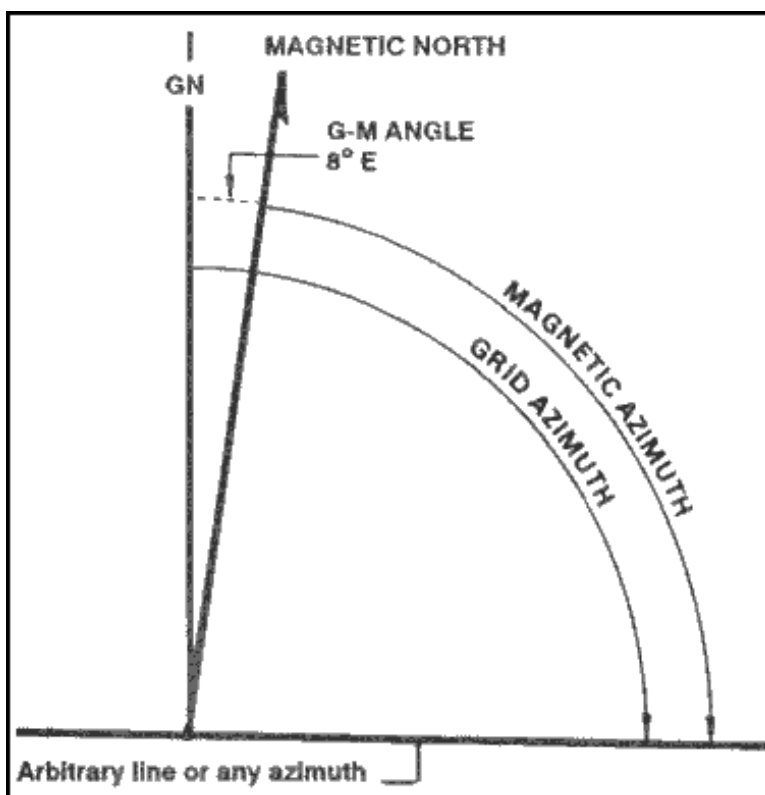


Figure 6-9. Declination diagram with arbitrary line.

(b) From the base of the grid-north line (prong), draw an arbitrary line (or any azimuth line) at a roughly right angle

to north, regardless of the actual value of the azimuth in degrees (Figure 6-9).

(c) Examine the declination diagram on the map and determine the direction of the magnetic north (right-left or east-west) relative to that of the grid-north prong. Draw a magnetic prong from the apex of the grid-north line in the desired direction (Figure 6-9).

(d) Determine the value of the G-M angle. Draw an arc from the grid prong to the magnetic prong and place the value of the G-M angle (Figure 6-9).

(e) Complete the diagram by drawing an arc from each reference line to the arbitrary line. A glance at the completed diagram shows whether the given azimuth or the desired azimuth is greater, and thus whether the known difference between the two must be added or subtracted.

(f) The inclusion of the true-north prong in relationship to the conversion is of little importance.

e. **Applications.** Remember, there are no negative azimuths on the azimuth circle. Since 0 degree is the same as 360 degrees, then 2 degrees is the same as 362 degrees. This is because 2 degrees and 362 degrees are located at the same point on the azimuth circle. The grid azimuth can now be converted into a magnetic azimuth because the grid azimuth is now larger than the G-M angle.

(1) When working with a map having an east G-M angle:

(a) To plot a magnetic azimuth on a map, first change it to a grid azimuth (Figure 6-10).



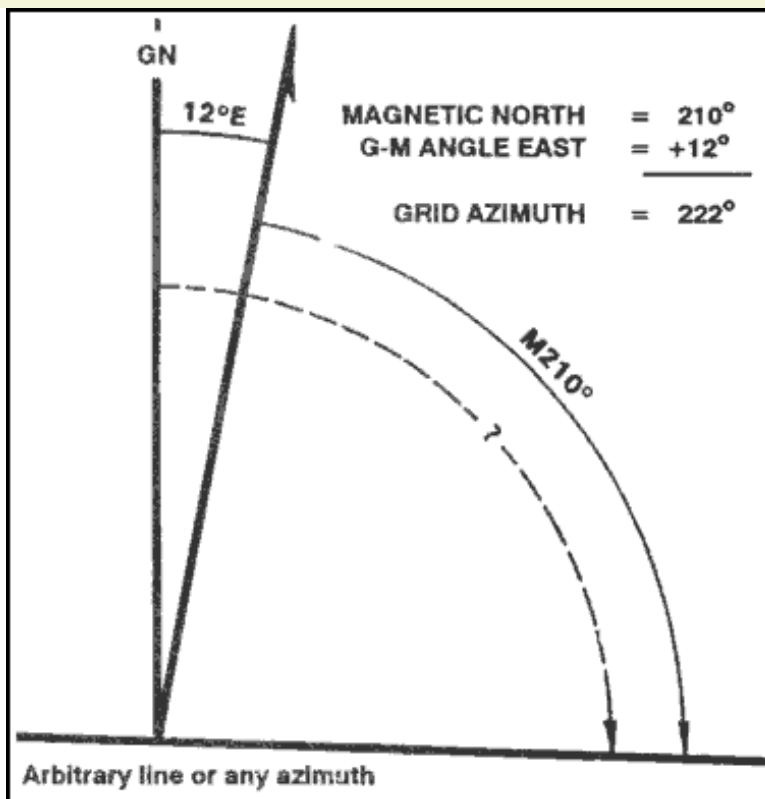
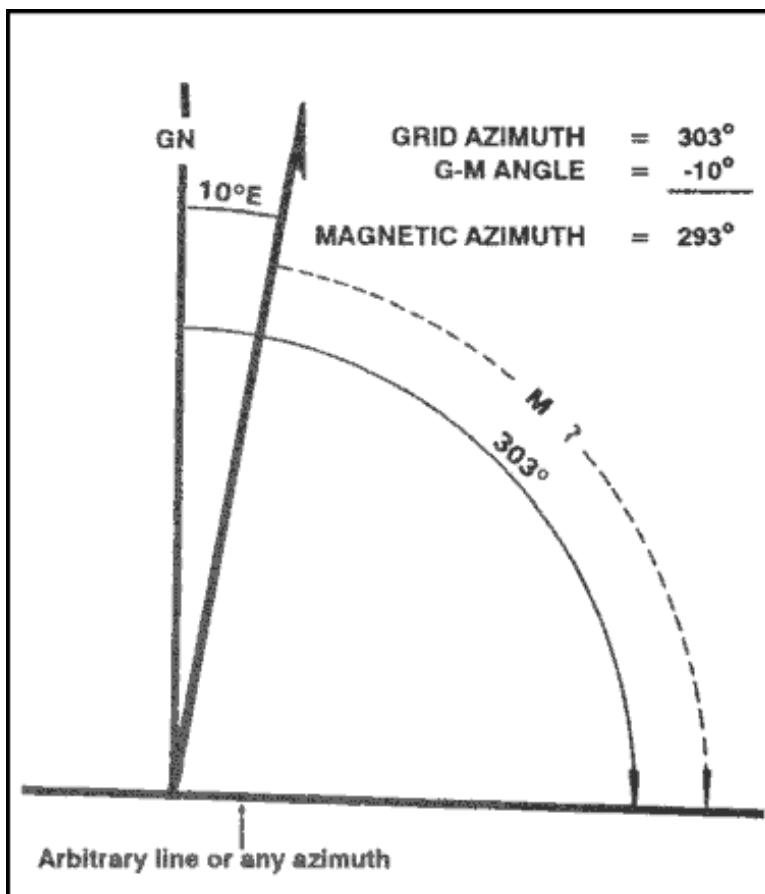


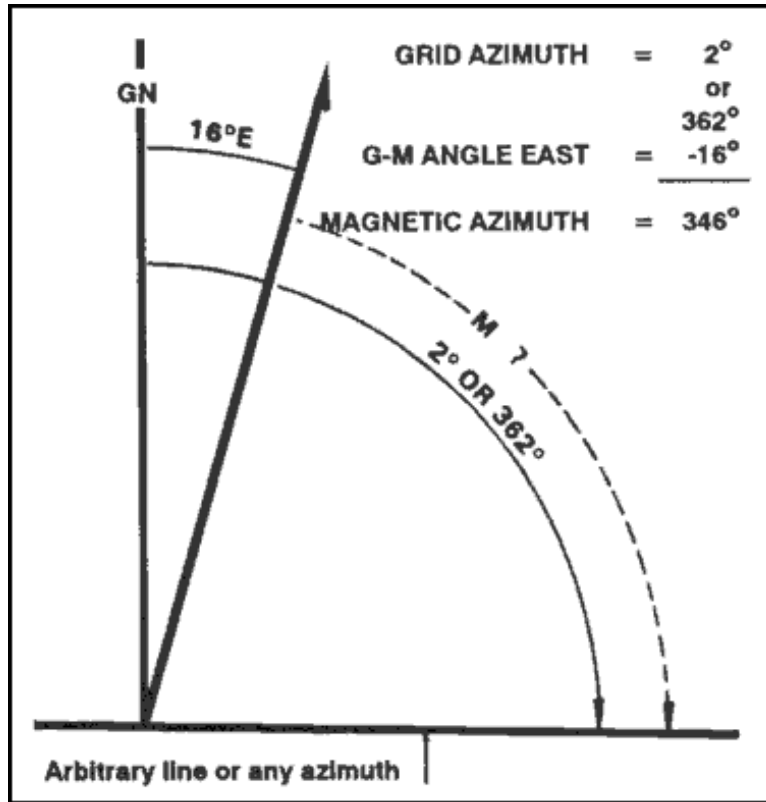
Figure 6-10. Converting to grid azimuth.

(b) To use a magnetic azimuth in the field with a compass, first change the grid azimuth plotted on a map to a magnetic azimuth (Figure 6-11).



**Figure 6-11. Converting to magnetic azimuth.**

(c) Convert a grid azimuth to a magnetic azimuth when the G-M angle is greater than a grid azimuth (Figure 6-12).



**Figure 6-12. Converting to a magnetic azimuth when the G-M angle is greater.**

(2) When working with a map having a west G-M angle:

(a) To plot a magnetic azimuth on a map, first convert it to a grid azimuth (Figure 6-13).

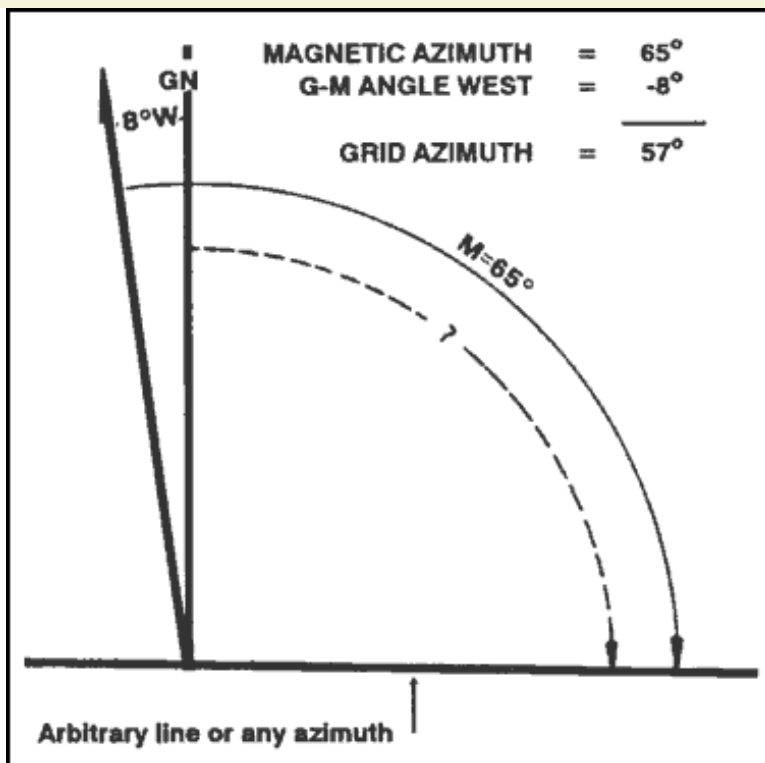


Figure 6-13. Converting to a grid azimuth on a map.

(b) To use a magnetic azimuth in the field with a compass, change the grid azimuth plotted on a map to a magnetic azimuth (Figure 6-14).

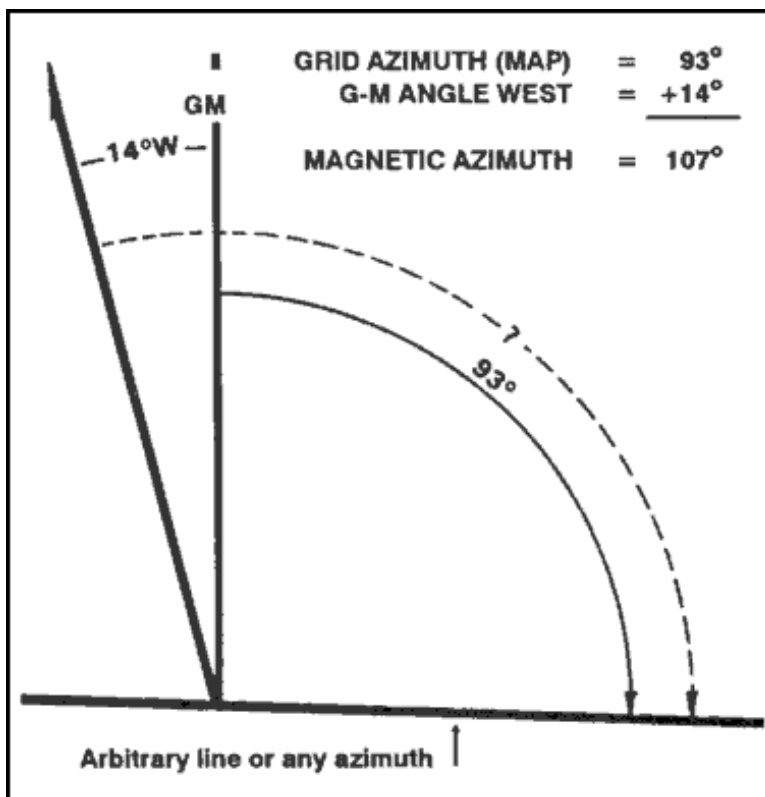
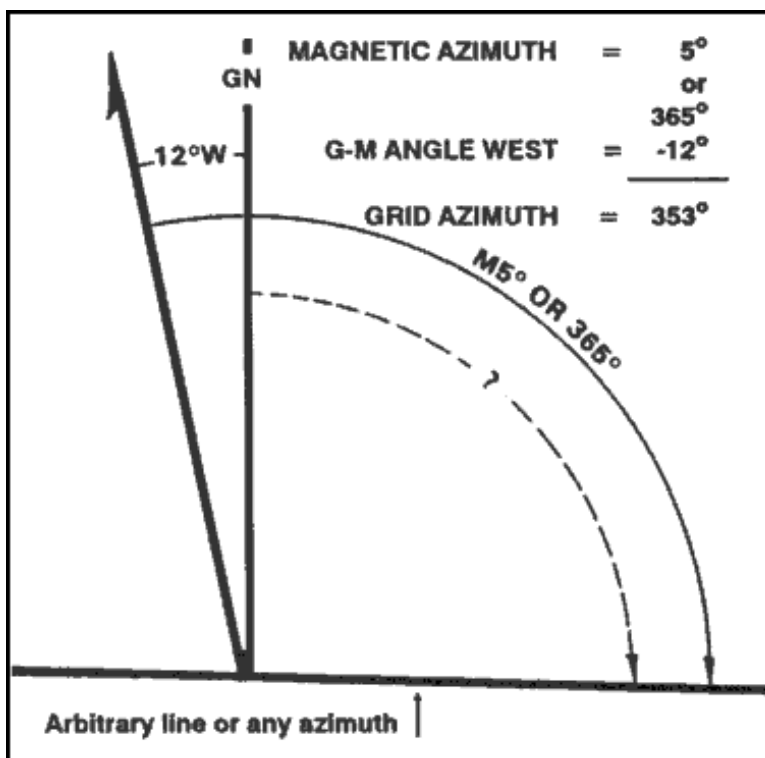


Figure 6-14. Converting to a magnetic azimuth on a map.

(c) Convert a magnetic azimuth when the G-M angle is

greater than the magnetic azimuth (Figure 6-15).



**Figure 6-15. Converting to a grid azimuth when the G-M angle is greater.**

(3) The G-M angle diagram should be constructed and used each time the conversion of azimuth is required. Such procedure is important when working with a map for the first time. It also may be convenient to construct a G-M angle conversion table on the margin of the map.

**NOTE:** When converting azimuths, exercise extreme care when adding and subtracting the G-M angle. A simple mistake of 1° could be significant in the field.

[Back to Direction](#)

Check out the **Amazon Coupons** before you buy.

Copyright © 2001-2002 Jalic LLC. All Rights Reserved.

[Disclaimer](#) | [Privacy Policy](#) | [Contact Us](#)



[Orienteering Home](#)

**The Sport:**

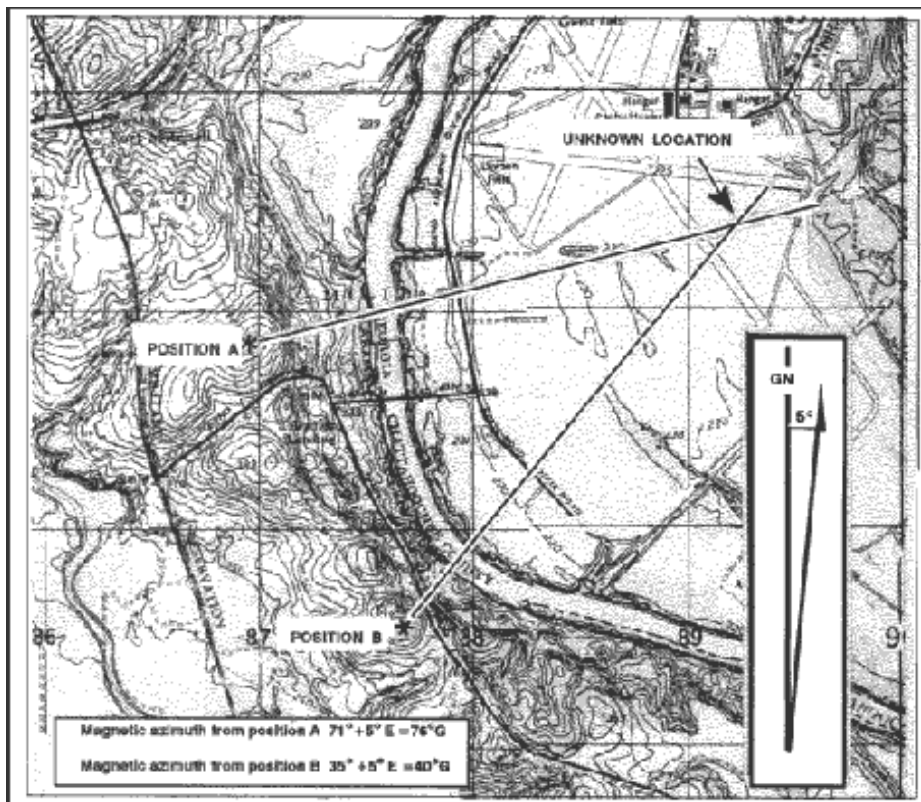
- [Orienteering History](#)
- [Orienteering Overview](#)
- [Course Setup](#)
- [Officials](#)
- [Start/Finish Areas](#)
- [Course Safety](#)
- [Control Point](#)
- [Guidelines](#)
- [Map Symbols](#)
- [Orienteering Techniques](#)
- [Civilian Orienteering](#)

**The Skills:**

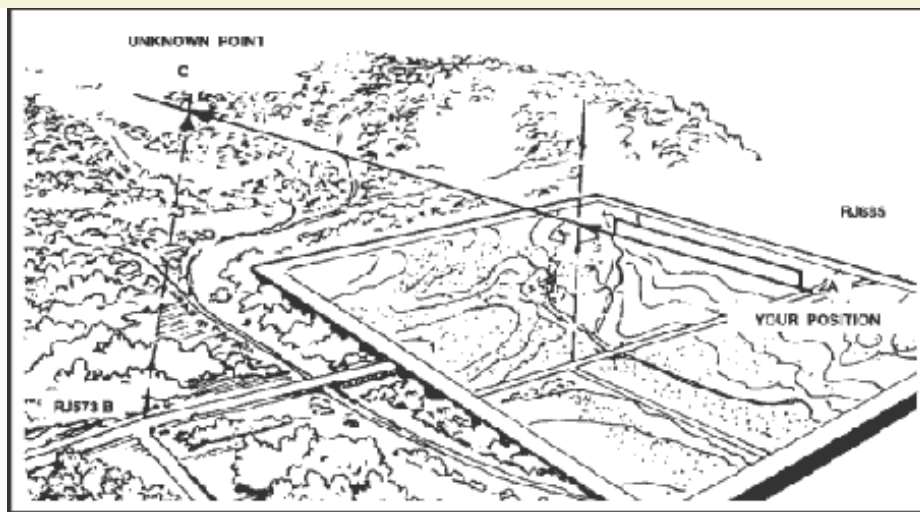
- [Maps](#)
- [Marginal Information and Symbols](#)
- [Grids](#)
- [Scale and Distance](#)
- [Direction](#)
- [Overlays](#)
- [Aerial Photographs](#)
- [Navigation](#)
- [Equipment and Methods](#)
- [Elevation and Relief](#)
- [Terrain Association](#)
- [Navigation in Different Types of Terrain](#)
- [Field Sketching](#)
- [Map Folding](#)
- [Techniques](#)
- [Units of Measure and Conversion Factors](#)

## Intersection

Intersection is the location of an unknown point by successively occupying at least two (preferably three) known positions on the ground and then map sighting on the unknown location. It is used to locate distant or inaccessible points or objects such as enemy targets and danger areas. There are two methods of intersection: the map and compass method and the straightedge method (Figures 6-16 and 6-17).



**Figure 6-16. Intersection, using map and compass.**



**Figure 6-17. Intersection, using a straightedge.**

- a. When using the map and compass method—
  - (1) Orient the map using the compass.
  - (2) Locate and mark your position on the map,
  - (3) Determine the magnetic azimuth to the unknown position using the compass.
  - (4) Convert the magnetic azimuth to grid azimuth.
  - (5) Draw a line on the map from your position on this grid azimuth.
  - (6) Move to a second known point and repeat steps 1, 2, 3, 4, and 5.
  - (7) The location of the unknown position is where the lines cross on the map. Determine the grid coordinates to the desired accuracy.
  
- b. The straight edge method is used when a compass is not available. When using it—
  - (1) Orient the map on a flat surface by the terrain association method.
  - (2) Locate and mark your position on the map.
  - (3) Lay a straight edge on the map with one end at the user's position (A) as a pivot point; then, rotate the straightedge until the unknown point is sighted along the edge.
  - (4) Draw a line along the straight edge
  - (5) Repeat the above steps at position (B) and check for accuracy.



(6) The intersection of the lines on the map is the location of the unknown point (C). Determine the grid coordinates to the desired accuracy (Figure 6-17).

[Back to Direction](#)

Check out the **Amazon Coupons** before you buy.

Copyright © 2001-2002 Jalic LLC. All Rights Reserved.

**[Disclaimer](#) | [Privacy Policy](#) | [Contact Us](#)**



# Orienteeing

## Orienteeing Home

### The Sport:

- **Orienteeing History**
- **Orienteeing**

### **Overview**

- **Course Setup**
- **Officials**
- **Start/Finish Areas**
- **Course Safety**
- **Control Point**

### **Guidelines**

- **Map Symbols**
- **Orienteeing**

### **Techniques**

- **Civilian Orienteeing**

### The Skills:

- **Maps**
- **Marginal Information and Symbols**

- **Grids**
- **Scale and Distance**
- **Direction**
- **Overlays**

- **Aerial Photographs**
- **Navigation**

### **Equipment and**

### **Methods**

- **Elevation and Relief**
- **Terrain Association**
- **Navigation in**

### **Different Types of Terrain**

- **Field Sketching**
- **Map Folding**

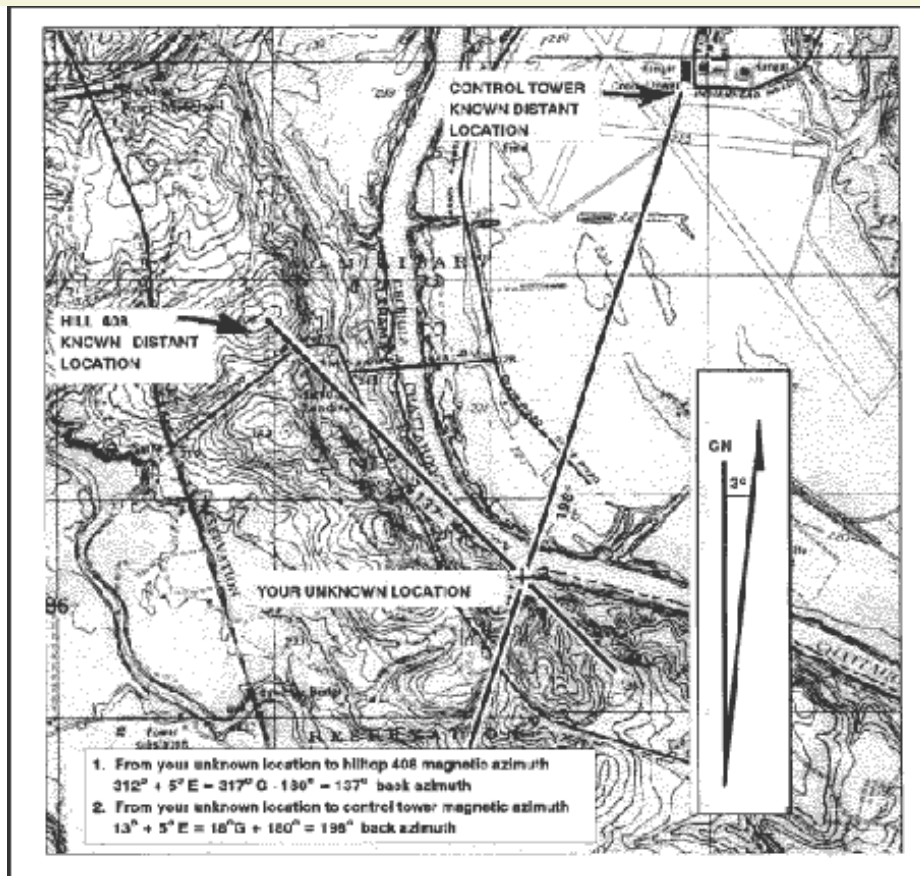
### **Techniques**

- **Units of Measure and Conversion Factors**

## Resection

Resection is the method of locating one's position on a map by determining the grid azimuth to at least two well-defined locations that can be pinpointed on the map. For greater accuracy, the desired method of resection would be to use three or more well-defined locations.

- a. When using the map and compass method (Figure 6-18)—
  - (1) Orient the map using the compass.
  - (2) Identify two or three known distant locations on the ground and mark them on the map.
  - (3) Measure the magnetic azimuth to one of the known positions from your location using a compass.
  - (4) Convert the magnetic azimuth to a grid azimuth.
  - (5) Convert the grid azimuth to a back azimuth. Using a protractor, draw a line for the back azimuth on the map from the known position back toward your unknown position.
  - (6) Repeat 3, 4, and 5 for a second position and a third position, if desired.
  - (7) The intersection of the lines is your location. Determine the grid coordinates to the desired accuracy.



**Figure 6-18. Resection with map and compass.**

- a. When using the straightedge method (Figure 6-19)—
  - (1) Orient the map on a flat surface by the terrain association method.
  - (2) Locate at least two known distant locations or prominent features on the ground and mark them on the map.
  - (3) Lay a straightedge on the map using a known position as a pivot point. Rotate the straightedge until the known position on the map is aligned with the known position on the ground.
  - (4) Draw a line along the straightedge away from the known position on the ground toward your position.
  - (5) Repeat 3 and 4 using a second known position.
  - (6) The intersection of the lines on the map is your location. Determine the grid coordinates to the desired accuracy.



**Figure 6-19. Resection with straightedge.**

### **6-9. MODIFIED RESECTION**

Modified resection is the method of locating one's position on the map when the person is located on a linear feature on the ground, such as a road, canal, or stream (Figure 6-20). Proceed as follows:

- a. Orient the map using a compass or by terrain association.
- b. Find a distant point that can be identified on the ground and on the map.
- c. Determine the magnetic azimuth from your location to the distant known point.
- d. Convert the magnetic azimuth to a grid azimuth.
- e. Convert the grid azimuth to a back azimuth. Using a protractor, draw a line for the back azimuth on the map from the known position back toward your unknown position.
- f. The location of the user is where the line crosses the linear feature. Determine the grid coordinates to the desired accuracy.

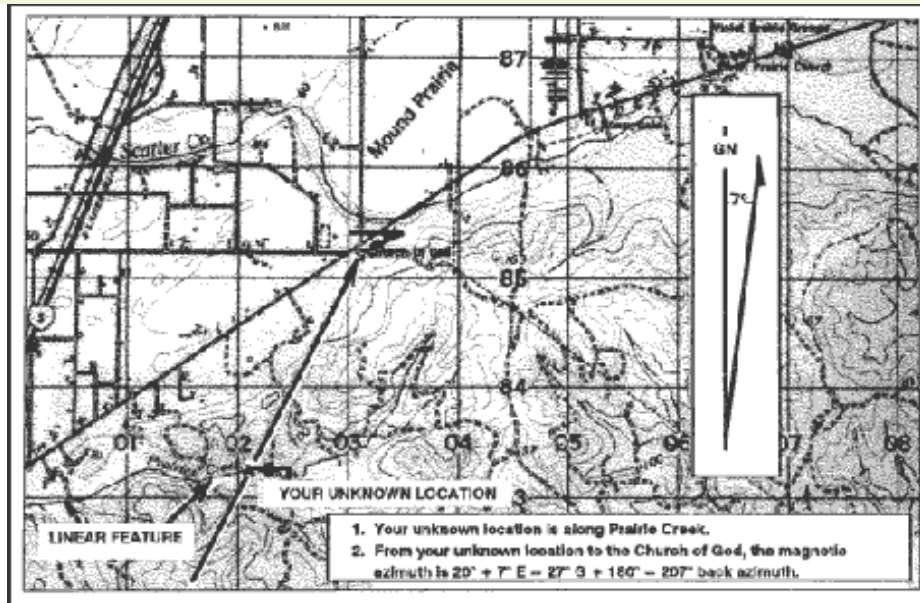


Figure 6-20. Modified resection.

[Back to Direction](#)

Check out the [Amazon Coupons](#) before you buy.

Copyright © 2001-2002 Jalic LLC. All Rights Reserved.  
[Disclaimer](#) | [Privacy Policy](#) | [Contact Us](#)





[Orienteering Home](#)

**The Sport:**

- [Orienteering History](#)
- [Orienteering](#)

**Overview**

- [Course Setup](#)
- [Officials](#)
- [Start/Finish Areas](#)
- [Course Safety](#)
- [Control Point](#)

**Guidelines**

- [Map Symbols](#)
- [Orienteering](#)

**Techniques**

- [Civilian Orienteering](#)

**The Skills:**

- [Maps](#)
- [Marginal Information and Symbols](#)
- [Grids](#)
- [Scale and Distance](#)
- [Direction](#)
- [Overlays](#)
- [Aerial Photographs](#)
- [Navigation](#)

**Equipment and Methods**

- [Elevation and Relief](#)
- [Terrain Association](#)
- [Navigation in](#)

**Different Types of Terrain**

- [Field Sketching](#)
- [Map Folding](#)

**Techniques**

- [Units of Measure and Conversion Factors](#)

## Polar Coordinates

A method of locating or plotting an unknown position from a known point by giving a direction and a distance along that direction line is called polar coordinates. The following elements must be present when using polar coordinates (Figure 6-21).

- Present known location on the map.
- Azimuth (grid or magnetic).
- Distance (in meters).

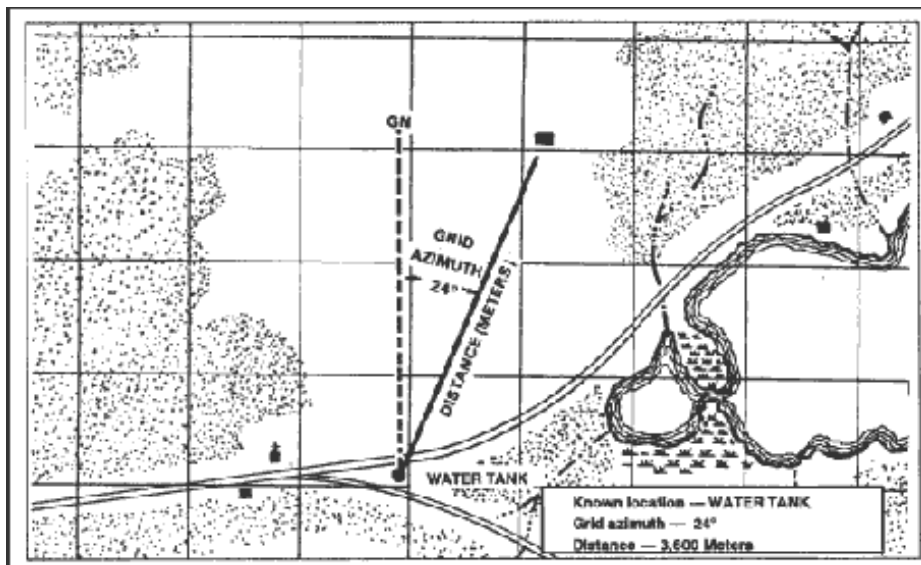


Figure 6-21. Polar plot.

Using the laser range finder to determine the range enhances your accuracy in determining the unknown position's location.

[Back to Direction](#)



Check out the **Amazon Coupons** before you buy.

Copyright © 2001-2002 Jalic LLC. All Rights Reserved.

**[Disclaimer](#) | [Privacy Policy](#) | [Contact Us](#)**



[Orienteering Home](#)

**The Sport:**

- [Orienteering History](#)
- [Orienteering](#)

**Overview**

- [Course Setup](#)
- [Officials](#)
- [Start/Finish Areas](#)
- [Course Safety](#)
- [Control Point](#)

**Guidelines**

- [Map Symbols](#)
- [Orienteering](#)

**Techniques**

- [Civilian Orienteering](#)

**The Skills:**

- [Maps](#)
- [Marginal Information and Symbols](#)
- [Grids](#)
- [Scale and Distance](#)
- [Direction](#)
- [Overlays](#)
- [Aerial Photographs](#)
- [Navigation](#)

**Equipment and Methods**

- [Elevation and Relief](#)
- [Terrain Association](#)
- [Navigation in](#)

**Different Types of Terrain**

- [Field Sketching](#)
- [Map Folding](#)

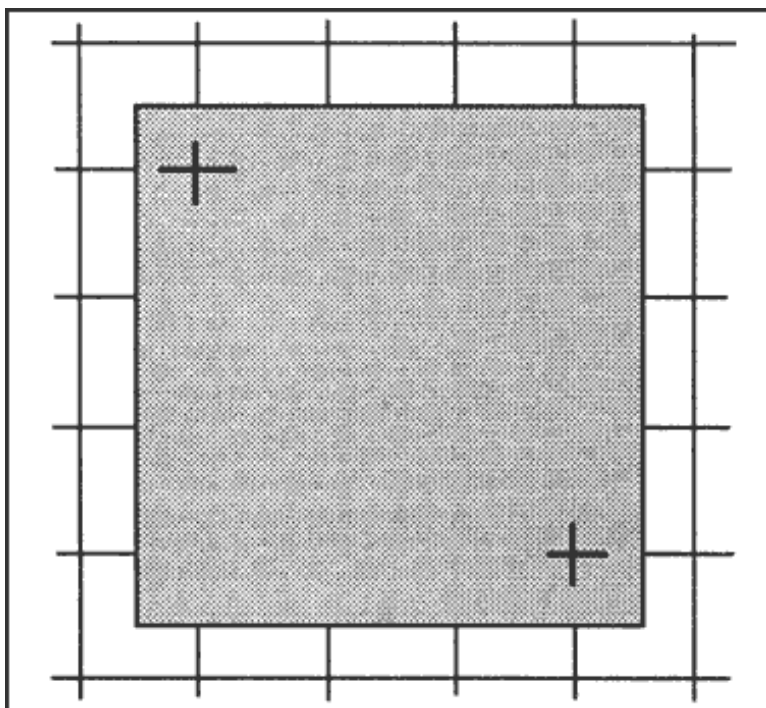
**Techniques**

- [Units of Measure and Conversion Factors](#)

## Map Overlays

Overlays are used to display military operations with enemy and friendly troop dispositions, and as supplements to orders sent to the field. They show detail that will aid in understanding the orders, displays of communication networks, and so forth. They are also used as annexes to reports made in the field because they can clarify matters that are difficult to explain clearly in writing.

There are three steps in the making of a map overlay—orienting the overlay material, plotting and symbolizing the detail, and adding the required marginal information (Figure 7-1).



**Figure 7-1. Registering the overlay.**

- a. **Orienting.** Orient the overlay over the place on the map to be annotated. Then, if possible, attach it to the edges of the map with tape. Trace the grid intersections nearest the two opposite corners of the overlay using a straightedge and label each with the proper grid coordinates. These register marks show the receiver of your overlay exactly where it fits on his map; without them, the overlay is difficult to orient. It is imperative that absolute accuracy be maintained in plotting

the register marks, as the smallest mistake will throw off the overlay.

b. **Plotting of New Detail.** Use pencils or markers in standard colors that make a lasting mark without cutting the overlay to plot any detail (FM 101-5-1).

(1) Use standard topographic or military symbols where possible. Nonstandard symbols invented by the author must be identified in a legend on the overlay. Depending on the conditions under which the overlay is made, it may be advisable to plot the positions first on the map, then trace them onto the overlay. Since the overlay is to be used as a supplement to orders or reports and the recipient will have an identical map, show only that detail with which the report is directly concerned.

(2) If you have observed any topographic or cultural features that are not shown on the map, such as a new road or a destroyed bridge, plot their positions as accurately as possible on the overlay and mark with the standard topographic symbol.

(3) If difficulty in seeing through the overlay material is encountered while plotting or tracing detail, lift the overlay from time to time to check orientation of information being added in reference to the base.

c. **Recording Marginal Information.** When all required detail has been plotted or traced on the overlay, print information as close to the lower right-hand corner as detail permits (Figure 7-2). This information includes the following data:

(1) **Title and Objective.** This tells the reader why the overlay was made and may also give the actual location. For example, "Road Reconnaissance" is not as specific as "Route 146 Road Reconnaissance."

(2) **Time and Date.** Any overlay should contain the latest possible information. An overlay received in time is very valuable to the planning staff and may affect the entire situation; an overlay that has been delayed for any reason may be of little use. Therefore, the exact time the information was obtained aids the receivers in determining its reliability and usefulness.

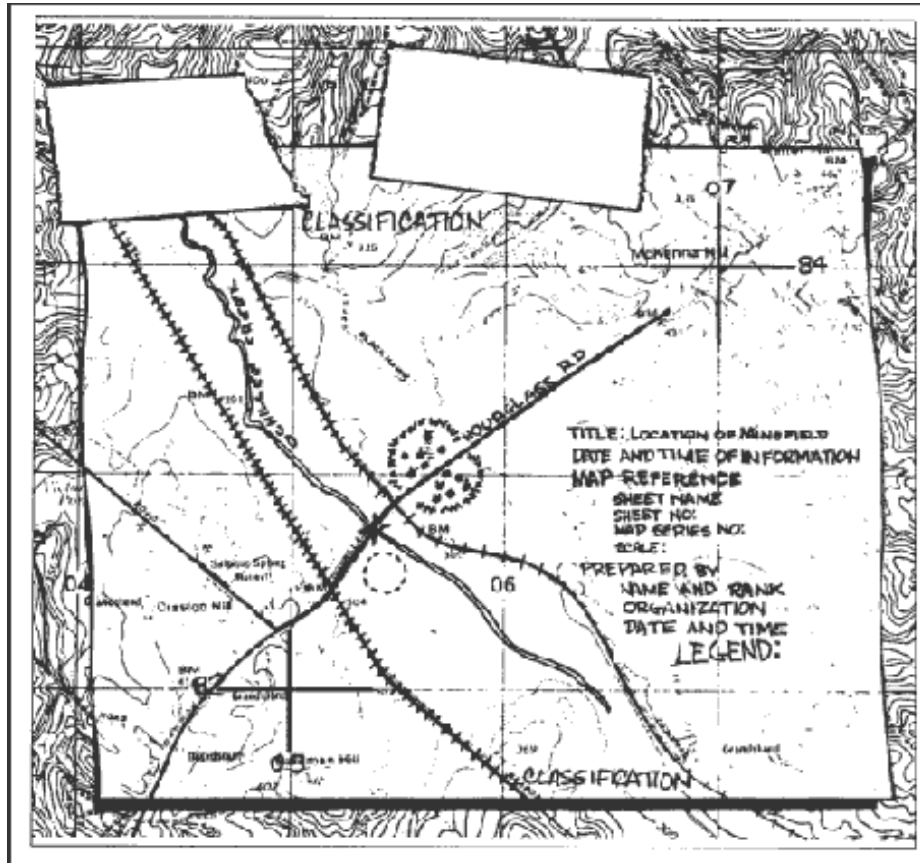
(3) **Map Reference.** The sheet name, sheet number, map series number, and scale must be included. If the reader does not have the map used for the overlay, this provides the information necessary to obtain it.

(4) **Author.** The name, rank, and organization of the author, supplemented with a date and time of preparation of the overlay, tells the reader if there was a time difference between when the information was obtained and when it was reported.

(5) **Legend.** If it is necessary to invent nonstandard symbols to show the required information, the legend must show what these symbols mean.

(6) **Security Classification.** This must correspond to the highest classification of either the map or the information placed on the overlay. If the information and map are unclassified, this will be so stated. The locations of the classification notes are shown in [Figure 7-2](#), and the notes will appear in both locations as shown.

(7) **Additional Information.** Any other information that amplifies the overlay will also be included. Make it as brief as possible.



**Figure 7-2. Map overlay with marginal information.**

[Back to Overlays](#)

Check out the [Amazon Coupons](#) before you buy.

Copyright © 2001-2002 Jalic LLC. All Rights Reserved.

[Disclaimer](#) | [Privacy Policy](#) | [Contact Us](#)



[Orienteering Home](#)

## Aerial Photograph Overlays

### The Sport:

- [Orienteering History](#)
- [Orienteering](#)

### Overview

- [Course Setup](#)
- [Officials](#)
- [Start/Finish Areas](#)
- [Course Safety](#)
- [Control Point](#)

### Guidelines

- [Map Symbols](#)
- [Orienteering](#)

### Techniques

- [Civilian Orienteering](#)

### The Skills:

- [Maps](#)
- [Marginal Information and Symbols](#)

### Grids

- [Scale and Distance](#)

### Direction

- [Overlays](#)

### Aerial Photographs

- [Navigation](#)

### Equipment and

### Methods

- [Elevation and Relief](#)
- [Terrain Association](#)
- [Navigation in](#)

### Different Types of

### Terrain

- [Field Sketching](#)

- [Map Folding](#)

### Techniques

- [Units of Measure and Conversion Factors](#)

Overlays of single aerial photographs are constructed and used in the same way as map overlays. The steps followed are essentially the same, with the following exceptions:

a. **Orienting of Overlay.** The photograph normally does not have grid lines to be used as register marks. The borders of the photograph limit the area of the overlay, so the reference marks or linear features are traced in place of grid register marks. Finally, to ensure proper location of the overlay with respect to the photograph, indicate on the overlay the position of the marginal data on the photograph as seen through the overlay.

b. **Marginal Information.** The marginal information shown on photographs varies somewhat from that shown on maps. Overlays of photographs (Figure 7-3) should show the following information:

(1) **North Arrow.** This may be obtained in two ways—by comparing with a map of the area or by orienting the photograph by inspection. In the latter case, a compass or expedient direction finder must be used to place the direction arrow on the overlay. Use the standard symbol to represent the actual north arrow used—grid, magnetic, or true north.

(2) **Title and Objective.** This tells the reader why the photo overlay was made and may also give the actual location.

(3) **Time and Date.** The exact time the information was obtained is shown on a photo overlay just as on a map overlay

(4) **Photo Reference.** The photo number, mission number, date of flight, and scale appear here, or the information is traced in its actual location on the photograph.

(5) **Scale.** The scale must be computed since it is not part of the marginal data.

(6) **Map Reference.** Reference is made to the sheet name, sheet number, series number, and scale of a map of the area, if one is available.



(7) **Author.** The name, rank, and organization of the author are shown, supplemented with a date and time of preparation of the overlay.

(8) **Legend.** As with map overlays, this is only necessary when nonstandard symbols are used.

(9) **Security Classification.** This must correspond to the highest classification of either the photograph or the information placed on the overlay. If the information and photograph are unclassified, this will be so stated. The locations of the classification notes are shown in Figure 7-3, and the notes will appear in both locations.

(10) **Additional Information.** Any other information that amplifies the overlay will also be included. Make it as brief as possible.

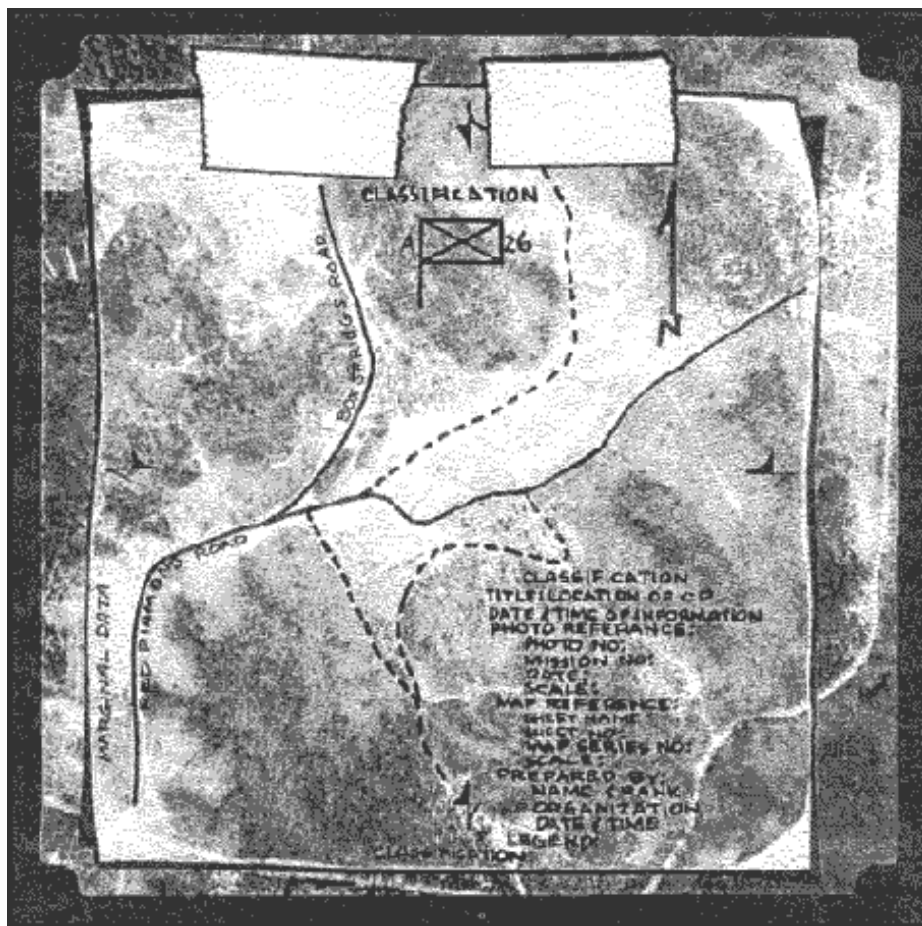


Figure 7-3. Photographic overlay with marginal information.

[Back to Overlays](#)

Check out the **Amazon Coupons** before you buy.



Copyright © 2001-2002 Jalic LLC. All Rights Reserved.

**[Disclaimer](#) | [Privacy Policy](#) | [Contact Us](#)**



[Orienteering Home](#)

The Sport:

- [Orienteering History](#)
- [Orienteering](#)

Overview

- [Course Setup](#)
- [Officials](#)
- [Start/Finish Areas](#)
- [Course Safety](#)
- [Control Point](#)

Guidelines

- [Map Symbols](#)
- [Orienteering](#)

Techniques

- [Civilian Orienteering](#)

The Skills:

- [Maps](#)
- [Marginal Information and Symbols](#)
- [Grids](#)
- [Scale and Distance](#)
- [Direction](#)
- [Overlays](#)
- [Aerial Photographs](#)
- [Navigation](#)

Equipment and

Methods

- [Elevation and Relief](#)
- [Terrain Association](#)
- [Navigation in](#)

Different Types of Terrain

- [Field Sketching](#)
- [Map Folding](#)

Techniques

- [Units of Measure and Conversion Factors](#)

## Comparison with Maps

A topographic map may be obsolete because it was compiled many years ago. A recent aerial photograph shows any changes that have taken place since the map was made. For this reason, maps and aerial photographs complement each other. More information can be gained by using the two together than by using either alone.

a. **Advantages.** An aerial photograph has the following advantages over a map:

- (1) It provides a current pictorial view of the ground that no map can equal.
- (2) It is more readily obtained. The photograph may be in the hands of the user within a few hours after it is taken; a map may take months to prepare.
- (3) It may be made for places that are inaccessible to ground soldiers.
- (4) It shows military features that do not appear on maps.
- (5) It can provide a day-to-day comparison of selected areas, permitting evaluations to be made of enemy activity.
- (6) It provides a permanent and objective record of the day-to-day changes with the area.

b. **Disadvantages.** The aerial photograph has the following disadvantages as compared to a map:

- (1) Ground features are difficult to identify or interpret without symbols and are often obscured by other ground detail as, for example, buildings in wooded areas.
- (2) Position location and scale are only approximate.
- (3) Detailed variations in the terrain features are not readily apparent without overlapping photography and a stereoscopic viewing instrument.

(4) Because of a lack of contrasting colors and tone, a photograph is difficult to use in poor light.

(5) It lacks marginal data.

(6) It requires more training to interpret than a map.

- Aerial Photography Types
- Numbering, Scale, & Indexing
- Orienting & Point Designation Grid
- Identification of Features & Stereo Vision

[Back to Aerial Photographs](#)

Check out the [Amazon Coupons](#) before you buy.

Copyright © 2001-2002 Jalic LLC. All Rights Reserved.

[Disclaimer](#) | [Privacy Policy](#) | [Contact Us](#)



[Orienteering Home](#)

The Sport:

- [Orienteering History](#)
- [Orienteering](#)

Overview

- [Course Setup](#)
- [Officials](#)
- [Start/Finish Areas](#)
- [Course Safety](#)
- [Control Point](#)

Guidelines

- [Map Symbols](#)
- [Orienteering](#)

Techniques

- [Civilian Orienteering](#)

The Skills:

- [Maps](#)
- [Marginal Information and Symbols](#)

- [Grids](#)
- [Scale and Distance](#)
- [Direction](#)
- [Overlays](#)

- [Aerial Photographs](#)
- [Navigation](#)

Equipment and

Methods

- [Elevation and Relief](#)
- [Terrain Association](#)
- [Navigation in](#)

Different Types of Terrain

- [Field Sketching](#)
- [Map Folding](#)

Techniques

- [Units of Measure and Conversion Factors](#)

## Types of Aerial Photographs

Aerial photography most commonly used by military personnel may be divided into two major types, the vertical and the oblique. Each type depends upon the attitude of the camera with respect to the earth's surface when the photograph is taken.

a. **Vertical.** A vertical photograph is taken with the camera pointed as straight down as possible (Figures 8-1 and 8-2). Allowable tolerance is usually + 3° from the perpendicular (plumb) line to the camera axis. The result is coincident with the camera axis. A vertical photograph has the following characteristics:

- (1) The lens axis is perpendicular to the surface of the earth.
- (2) It covers a relatively small area.
- (3) The shape of the ground area covered on a single vertical photo closely approximates a square or rectangle.
- (4) Being a view from above, it gives an unfamiliar view of the ground.
- (5) Distance and directions may approach the accuracy of maps if taken over flat terrain.
- (6) Relief is not readily apparent.

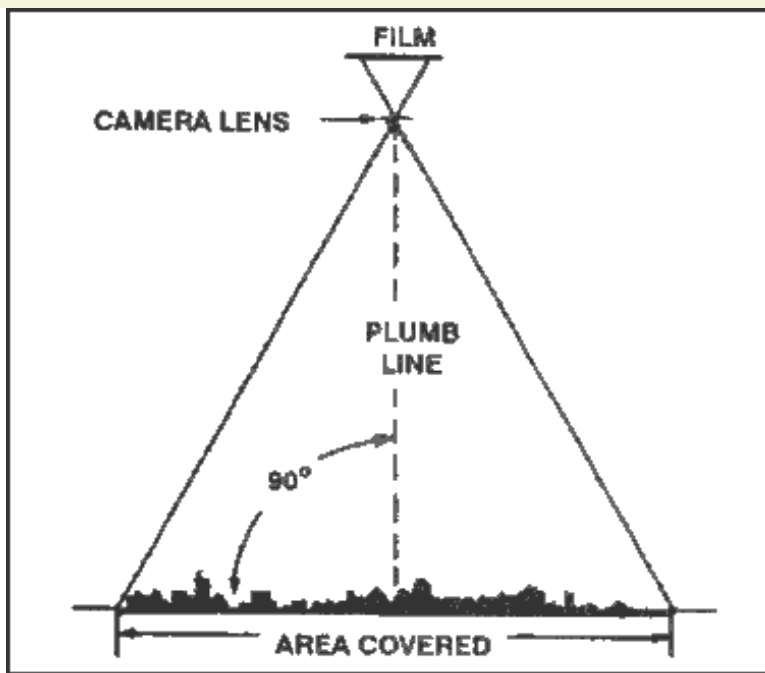


Figure 8-1. Relationship of the vertical aerial photograph with the ground.

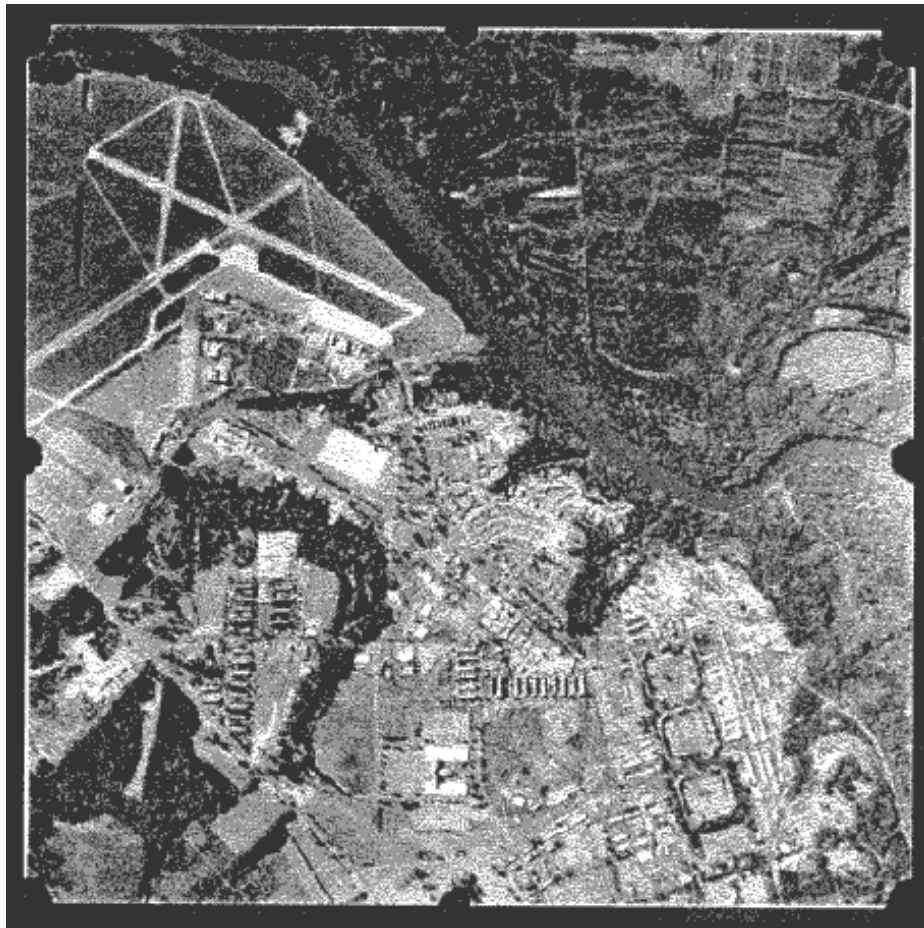


Figure 8-2. Vertical photograph.

a. **Low Oblique.** This is a photograph taken with the camera inclined about  $30^\circ$  from the vertical (Figure 8-3, and Figure 8-4). It is used to study

an area before an attack, to substitute for a reconnaissance, to substitute for a map, or to supplement a map. A low oblique has the following characteristics:

- (1) It covers a relatively small area.
- (2) The ground area covered is a trapezoid, although the photo is square or rectangular.
- (3) The objects have a more familiar view, comparable to viewing from the top of a high hill or tall building.
- (4) No scale is applicable to the entire photograph, and distance cannot be measured. Parallel lines on the ground are not parallel on this photograph; therefore, direction (azimuth) cannot be measured.
- (5) Relief is discernible but distorted.
- (6) It does not show the horizon.

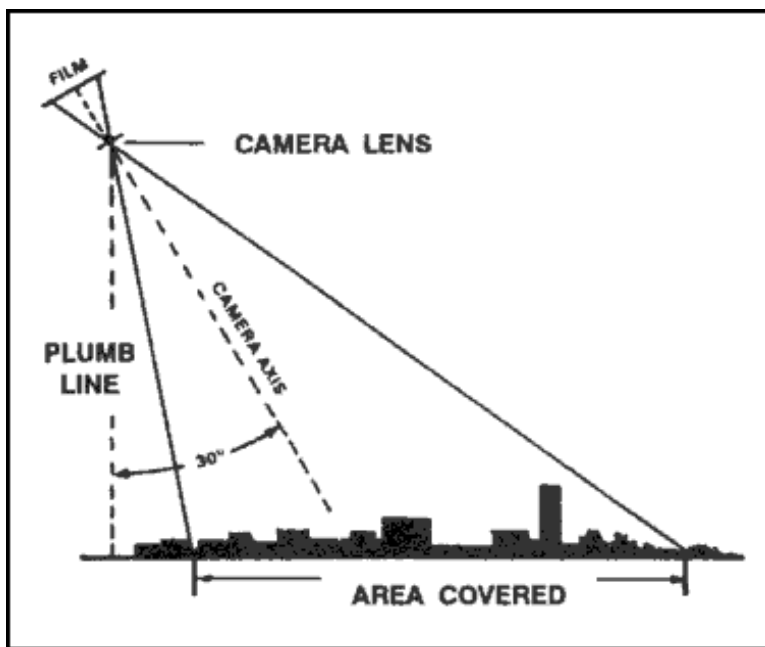
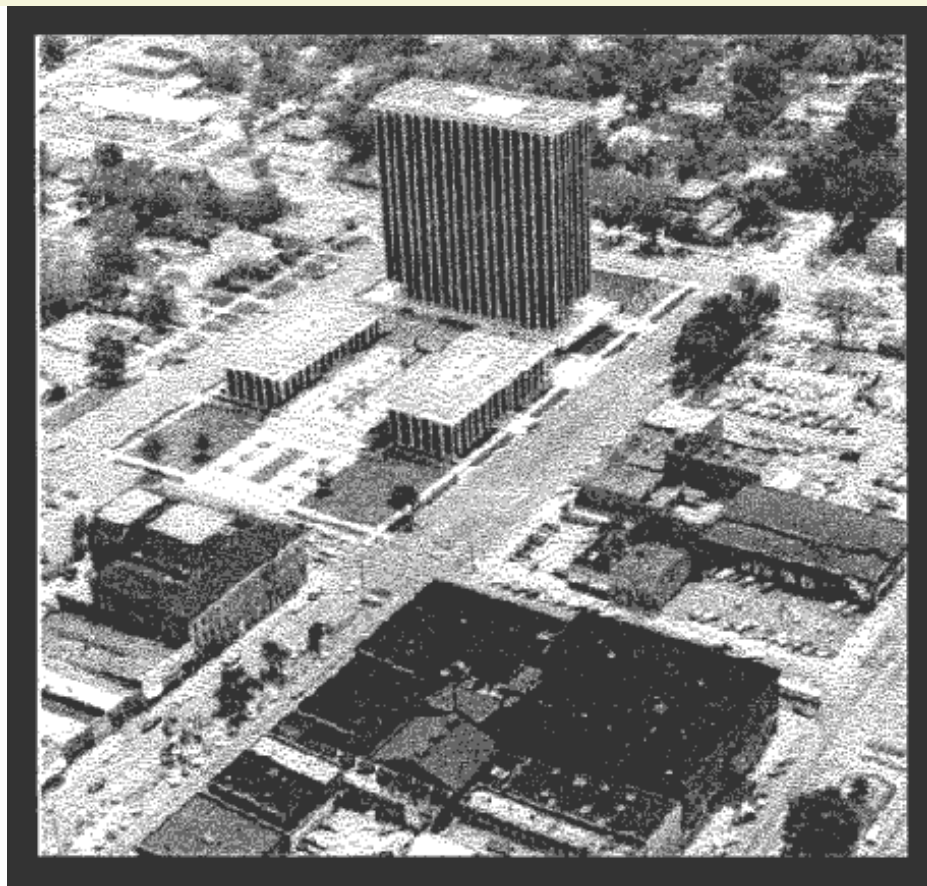


Figure 8-3. Relationship of low oblique photograph to the ground.





**Figure 8-4. Low oblique photograph.**

c. **High Oblique.** The high oblique is a photograph taken with the camera inclined about  $60^\circ$  from the vertical (Figures 8-5 and 8-6). It has a limited military application; it is used primarily in the making of aeronautical charts. However, it may be the only photography available. A high oblique has the following characteristics:

- (1) It covers a very large area (not all usable).
- (2) The ground area covered is a trapezoid, but the photograph is square or rectangular.
- (3) The view varies from the very familiar to unfamiliar, depending on the height at which the photograph is taken.
- (4) Distances and directions are not measured on this photograph for the same reasons that they are not measured on the low oblique.
- (5) Relief may be quite discernible but distorted as in any oblique view. The relief is not apparent in a high altitude, high oblique.
- (6) The horizon is always visible.

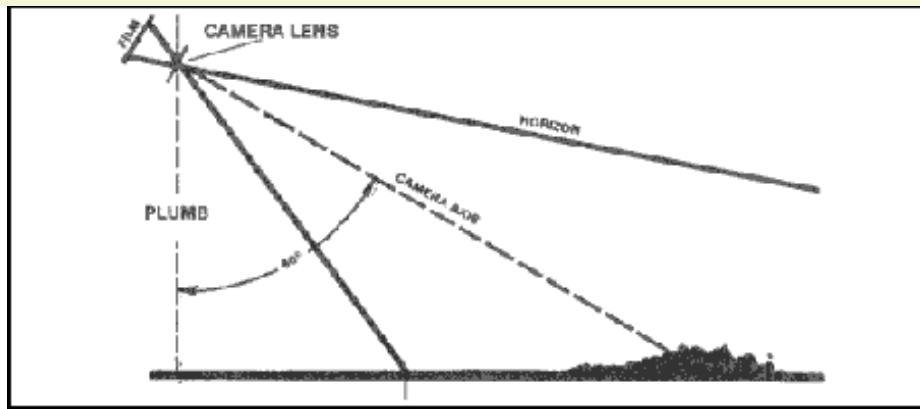
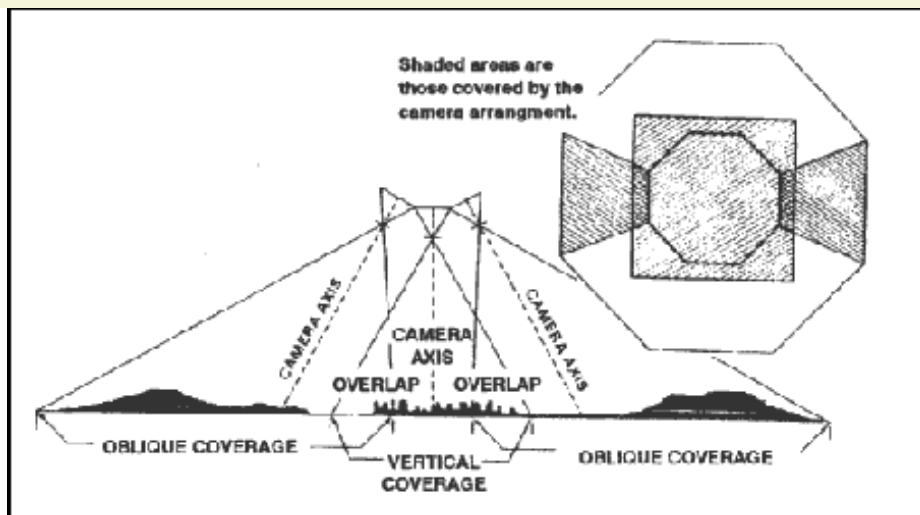


Figure 8-5. Relationship of high oblique photograph to the ground.



Figure 8-6. High oblique photograph.

d. **Trimetrogon.** This is an assemblage of three photographs taken at the same time, one vertical and two high obliques, in a direction at right angle to the line of flight. The obliques, taken at an angle of  $60^\circ$  from the vertical, sidelap the vertical photography, producing composites from horizon to horizon (Figure 8-7).



**Figure 8-7. Relationship of cameras to ground for trimetrogon photography (three cameras).**

e. **Multiple Lens Photography.** These are composite photographs taken with one camera having two or more lenses, or by two or more cameras. The photographs are combinations of two, four, or eight obliques around a vertical. The obliques are rectified to permit assembly as verticals on a common plane.

f. **Convergent Photography.** These are done with a single twin-lens, wide-angle camera, or with two single-lens, wide-angle cameras coupled rigidly in the same mount so that each camera axis converges when intentionally tilted a prescribed amount (usually 15 or 20°) from the vertical. Again, the cameras are exposed at the same time. For precision mapping, the optical axes of the cameras are parallel to the line of flight, and for reconnaissance photography, the camera axes are at high angles to the line of flight.

g. **Panoramic.** The development and increasing use of panoramic photography in aerial reconnaissance has resulted from the need to cover in greater detail more and more areas of the world.

(1) To cover the large areas involved, and to resolve the desired ground detail, present-day reconnaissance systems must operate at extremely high-resolution levels. Unfortunately, high-resolution levels and wide-angular coverage are basically contradicting requirements.

(2) A panoramic camera is a scanning type of camera that sweeps the terrain of interest from side to side across the direction of flight. This permits the panoramic camera to record a much wider area of ground than either frame or strip cameras. As in the case of the frame cameras, continuous cover is obtained by properly spaced exposures timed to give sufficient overlap between frames. Panoramic cameras are most advantageous for applications requiring the resolution of small ground detail from high altitudes.

[Back to Aerial Photographs](#)

Check out the **Amazon Coupons** before you buy.

Copyright © 2001-2002 Jalic LLC. All Rights Reserved.

**[Disclaimer](#) | [Privacy Policy](#) | [Contact Us](#)**



[Orienteering Home](#)

## Types of Film

### The Sport:

- [Orienteering History](#)

- [Orienteering](#)

### Overview

- [Course Setup](#)

- [Officials](#)

- [Start/Finish Areas](#)

- [Course Safety](#)

- [Control Point](#)

### Guidelines

- [Map Symbols](#)

- [Orienteering](#)

### Techniques

- [Civilian Orienteering](#)

### The Skills:

- [Maps](#)

- [Marginal Information](#)

- [and Symbols](#)

- [Grids](#)

- [Scale and Distance](#)

- [Direction](#)

- [Overlays](#)

- [Aerial Photographs](#)

- [Navigation](#)

### Equipment and

### Methods

- [Elevation and Relief](#)

- [Terrain Association](#)

- [Navigation in](#)

### Different Types of

### Terrain

- [Field Sketching](#)

- [Map Folding](#)

### Techniques

- [Units of Measure and](#)

- [Conversion Factors](#)

Types of film generally used in aerial photography include panchromatic, infrared, and color. Camouflage detection film is also available.

a. **Panchromatic.** This is the same type of film that is used in the average hand-held small camera. It records the amount of light reflected from objects in tones of gray running from white to black. Most aerial photography is taken with panchromatic film.

b. **Infrared.** This is a black-and-white film that is sensitive to infrared waves. It can be used to detect artificial camouflage materials and to take photographs at night if there is a source of infrared radiation.

c. **Color.** This film is the same as that used in the average hand-held camera. It is limited in its use because of the time required to process it and its need for clear, sunny weather.

d. **Camouflage Detection.** This film is a special type that records natural vegetation in a reddish color. When artificial camouflage materials are photographed, they appear bluish or purplish. The name of this film indicates its primary use.

[Back to Aerial Photographs](#)

Check out the [Amazon Coupons](#) before you buy.

Copyright © 2001-2002 Jalic LLC. All Rights Reserved.

[Disclaimer](#) | [Privacy Policy](#) | [Contact Us](#)







[Orienteering Home](#)

The Sport:

- [Orienteering History](#)
- [Orienteering](#)

Overview

- [Course Setup](#)
- [Officials](#)
- [Start/Finish Areas](#)
- [Course Safety](#)
- [Control Point](#)

Guidelines

- [Map Symbols](#)
- [Orienteering](#)

Techniques

- [Civilian Orienteering](#)

The Skills:

- [Maps](#)
- [Marginal Information and Symbols](#)

- [Grids](#)
- [Scale and Distance](#)
- [Direction](#)
- [Overlays](#)

- [Aerial Photographs](#)
- [Navigation](#)

Equipment and

Methods

- [Elevation and Relief](#)
- [Terrain Association](#)
- [Navigation in](#)

Different Types of Terrain

- [Field Sketching](#)
- [Map Folding](#)

Techniques

- [Units of Measure and Conversion Factors](#)

## Scale Determination

Before a photograph can be used as a map supplement or substitute, it is necessary to know its scale. On a map, the scale is printed as a representative fraction that expresses the ratio of map distance to ground distance, For example:

$$RF = \frac{MD}{GD}$$

On a photograph, the scale is also expressed as a ratio, but is the ratio of the photo distance (*PD*) to ground distance. For example:

$$RF = \frac{PD}{GD}$$

The approximate scale or average scale (*RF*) of a vertical aerial photograph is determined by either of two methods; the comparison method or the focal length-flight altitude method.

- a. **Comparison Method.** The scale of a vertical aerial photograph is determined by comparing the measured distance between two points on the photograph with the measured ground distance between the same two points.

$$SCALE (RF) = \frac{Photo Distance}{Ground Distance}$$

The ground distance is determined by actual measurement on the ground or by the use of the scale on a map of the same area. The points selected on the photograph must be identifiable on the ground or map of the same area and should be spaced in such a manner that a line connecting them will pass through or nearly through the center of the photograph (Figure 8-8).

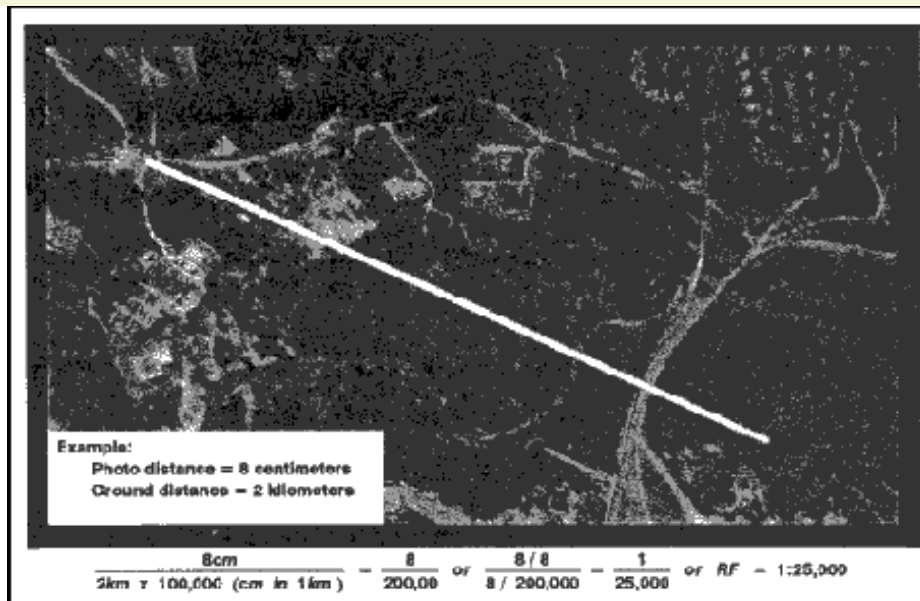


Figure 8-8. Selection of points for scale determination.

b. **Focal Length-Flight Altitude Method.** When the marginal information of a photograph includes the focal length and the flight altitude, the scale of the photo is determined using the following formula (Figure 8-9).

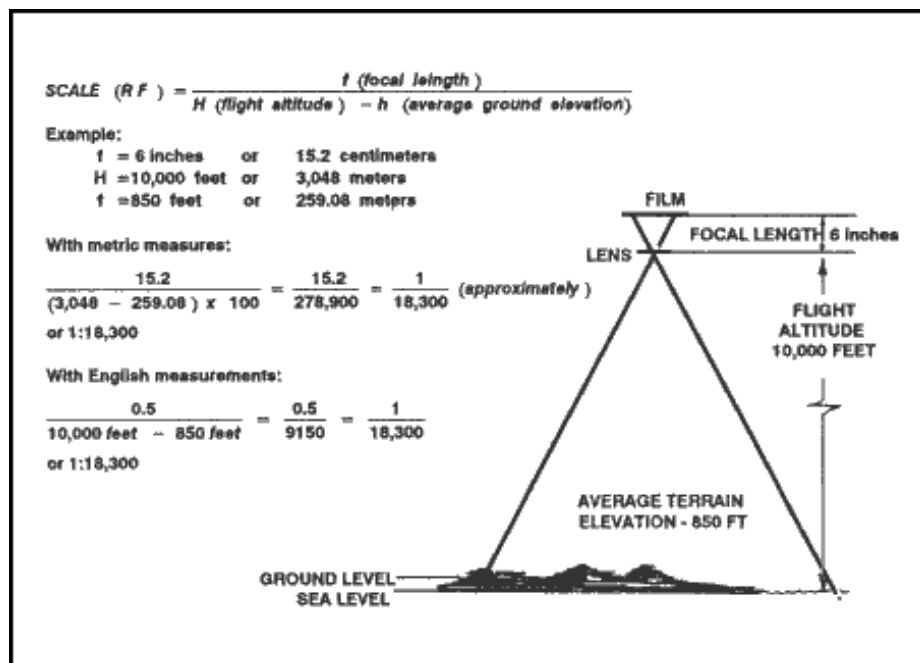


Figure 8-9. Computation of scale from terrain level.

When the ground elevation is at sea level, H becomes zero, and the formula is as shown in Figure 8-10.

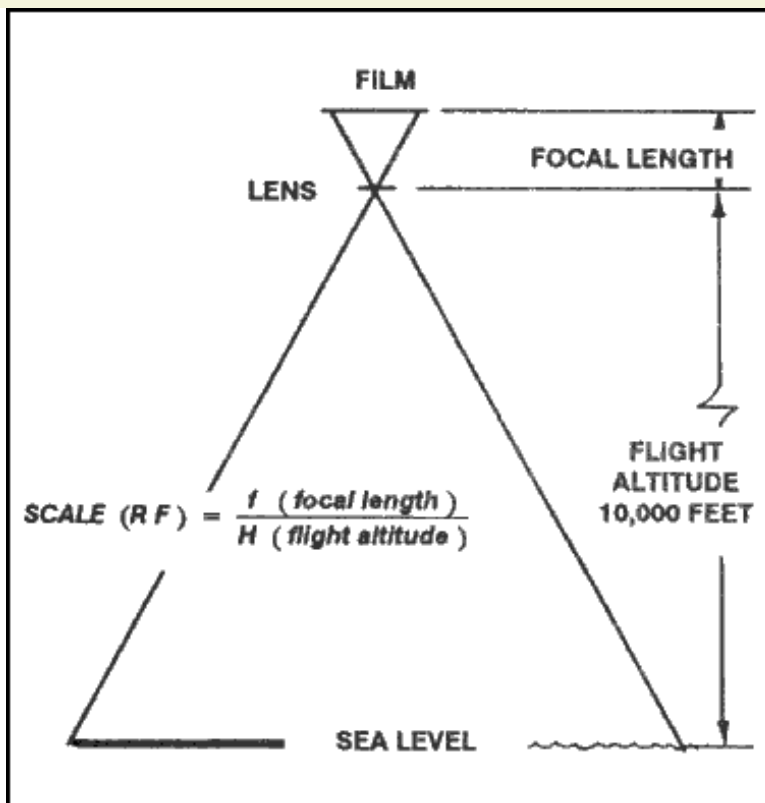


Figure 8-10. Basic computation of scale from sea level.

[Back to Aerial Photographs](#)

Check out the [Amazon Coupons](#) before you buy.

Copyright © 2001-2002 Jalic LLC. All Rights Reserved.

[Disclaimer](#) | [Privacy Policy](#) | [Contact Us](#)



[Orienteering Home](#)

**The Sport:**

- [Orienteering History](#)
- [Orienteering Overview](#)

**Overview**

- [Course Setup](#)
- [Officials](#)
- [Start/Finish Areas](#)
- [Course Safety](#)
- [Control Point](#)

**Guidelines**

- [Map Symbols](#)
- [Orienteering Techniques](#)

**Techniques**

- [Civilian Orienteering](#)

**The Skills:**

- [Maps](#)
- [Marginal Information and Symbols](#)
- [Grids](#)
- [Scale and Distance](#)
- [Direction](#)
- [Overlays](#)
- [Aerial Photographs](#)
- [Navigation](#)
- [Equipment and Methods](#)
- [Elevation and Relief](#)
- [Terrain Association](#)
- [Navigation in Different Types of Terrain](#)

- [Field Sketching](#)
- [Map Folding](#)

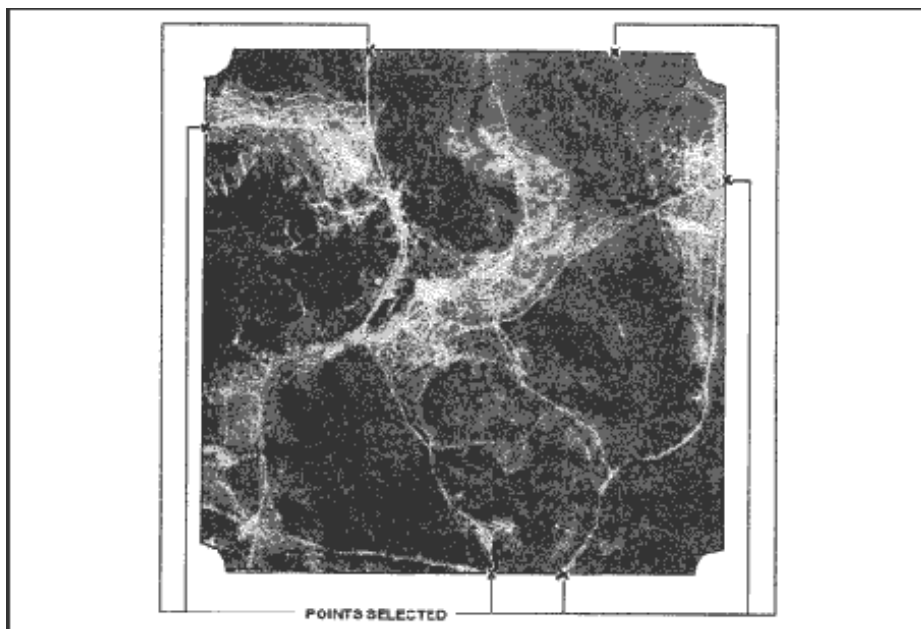
**Techniques**

- [Units of Measure and Conversion Factors](#)

## Indexing

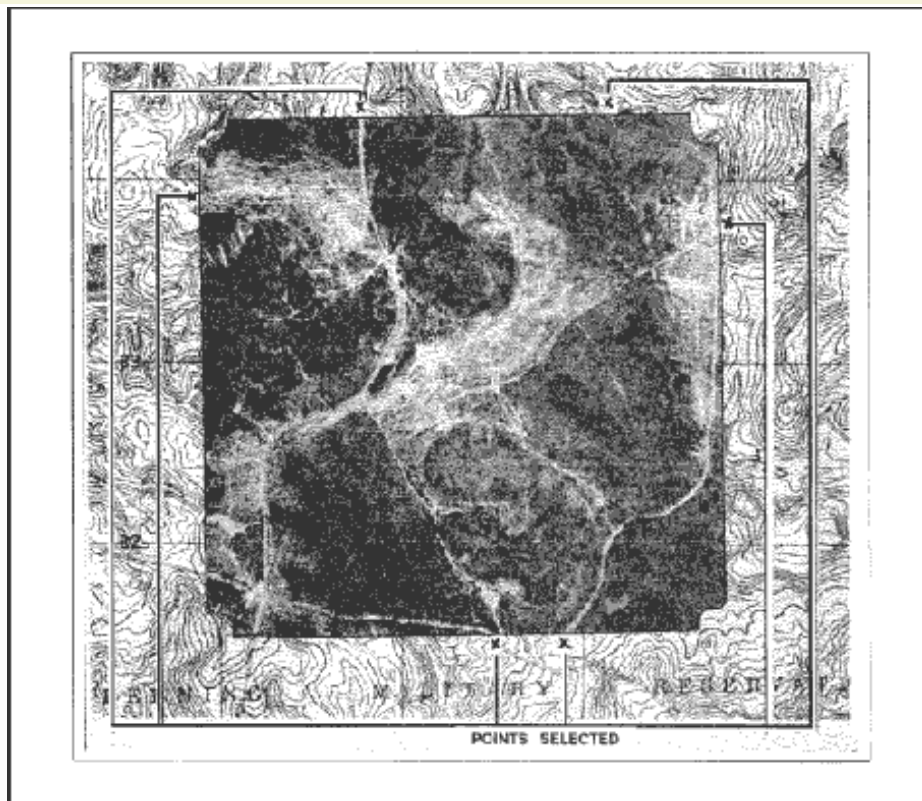
When aerial photos are taken of an area, it is convenient to have a record of the extent of coverage of each photo. A map on which the area covered by each photo is outlined and numbered or indexed to correspond to the photo is called an index map. There are two methods of preparing index maps.

- a. The four-corner method (Figures 8-11 and 8-12) requires location on the map of the exact point corresponding to each corner of the photo. If a recognizable object such as a house or road junction can be found exactly at one of the corners, this point may be used on the map as the corner of the photo. If recognizable objects cannot be found at the corners, then the edges of the photo should be outlined on the map by lining up two or more identifiable objects along each edge; the points where the edges intersect should be the exact corners of the photo. If the photo is not a perfect vertical, the area outlined on the map will not be a perfect square or rectangle. After the four sides are drawn on the map, the number of the photograph is written in the enclosed area for identification. This number should be placed in the same corner as it is on the photo.



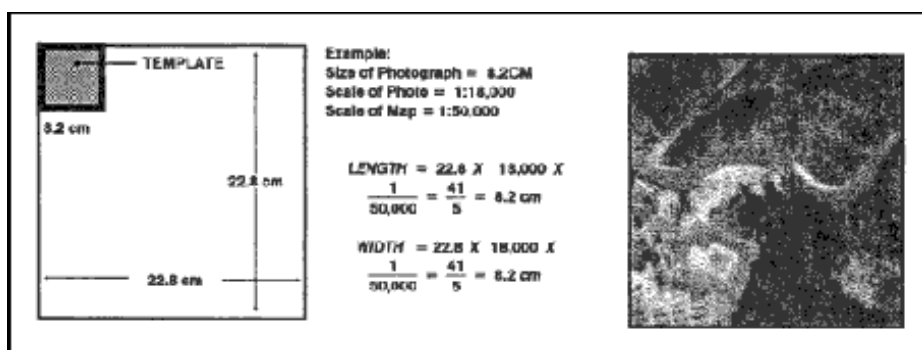
**Figure 8-11. Four-corner method (selection of points).**





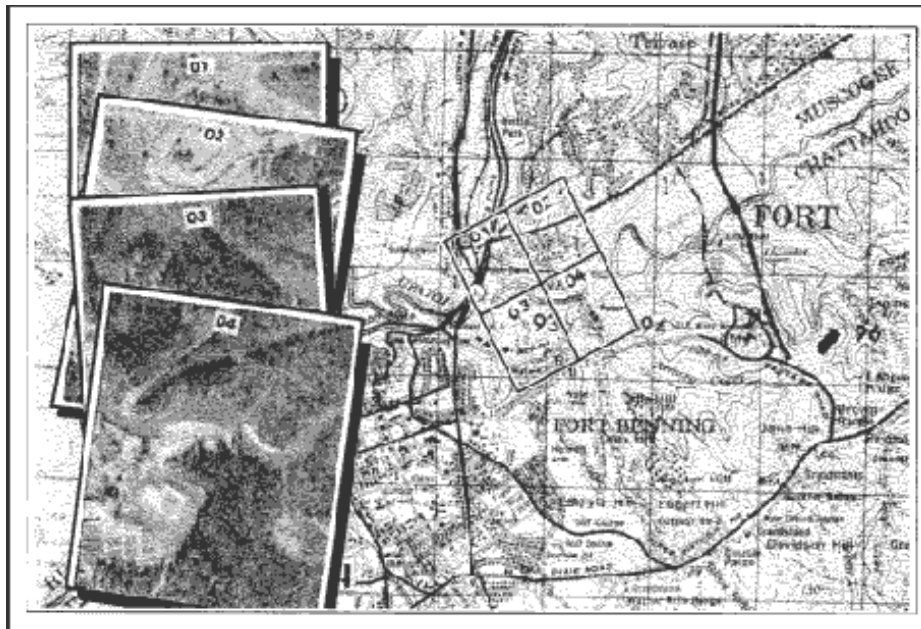
**Figure 8-12. Plotting, using the four-corner method.**

b. The template method is used when a large number of photos are to be indexed, and the exact area covered by each is not as important as approximate area and location. In this case, a template (cardboard pattern or guide) is cut to fit the average area the photos cover on the index map. It is used to outline the individual area covered by each photo. To construct a template, find the average map dimensions covered by the photos to be indexed as follows. Multiply the average length of the photos by the denominator of the average scale of the photos; multiply this by the scale of the map. Do the same for the width of the photos. This gives the average length and width of the area each photo covers on the map--or the size to which the template should be cut (Figure 8-13).



**Figure 8-13. Constructing a template.**

c. To index the map, select the general area covered by the first photo and orient the photo to the map. Place the template over the area on the map and adjust it until it covers the area as completely and accurately as possible. Draw lines around the edges of the template. Remove the rectangle and proceed to the next photo (Figure 8-14).



**Figure 8-14. Indexing with a template.**

- d. After all photos have been plotted, write on the map sufficient information to identify the mission or sortie. If more than one sortie is plotted on one map or overlay, use a different color for each sortie.
  
- e. In most cases, when a unit orders aerial photography, an index is included to give the basic information. Instead of being annotated on a map of the area, it appears on an overlay and is keyed to a map.

[Back to Aerial Photographs](#)

Check out the **Amazon Coupons** before you buy.

Copyright © 2001-2002 Jalic LLC. All Rights Reserved.

**Disclaimer | Privacy Policy | Contact Us**





[Orienteering Home](#)

## Orienteering of Photographs

### The Sport:

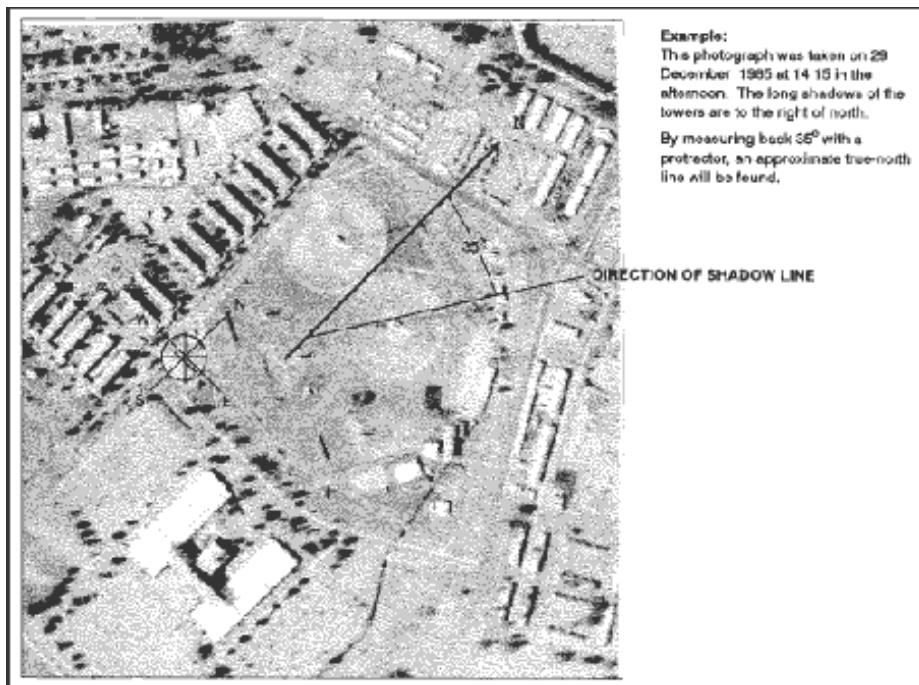
- [Orienteering History](#)
- [Orienteering Overview](#)
- [Course Setup](#)
- [Officials](#)
- [Start/Finish Areas](#)
- [Course Safety](#)
- [Control Point](#)
- [Guidelines](#)
- [Map Symbols](#)
- [Orienteering Techniques](#)
- [Civilian Orienteering](#)

### The Skills:

- [Maps](#)
- [Marginal Information and Symbols](#)
- [Grids](#)
- [Scale and Distance](#)
- [Direction](#)
- [Overlays](#)
- [Aerial Photographs](#)
- [Navigation](#)
- [Equipment and Methods](#)
- [Elevation and Relief](#)
- [Terrain Association](#)
- [Navigation in Different Types of Terrain](#)
- [Field Sketching](#)
- [Map Folding](#)
- [Techniques](#)
- [Units of Measure and Conversion Factors](#)

Orienteering the photograph is important because it is of very little value as a map supplement or substitute if its location and direction are not known by the user.

- a. If a map of the same area as the photograph is available, the photograph is oriented to the map by comparing features common to both and then transferring a direction line from the map to the photograph.
- b. If no map is available, the shadows on a photograph may be used to get an approximate true-north line. This method is not recommended in the torrid zone (Figure 8-15).



**Figure 8-15. Using shadows on a photograph to find north.**

(1) **North Temperate Zone.** The sun moves from the east in the morning through south at noon to west in the afternoon. Conversely, shadow fall varies from west through north to east. Before noon, therefore, north is to the right of the direction of shadow fall; at noon, north is the direction of shadow fall; and after noon, north is to the left of shadow fall. On an average, the amount of variation in shadow fall per hour is 15 degrees. From

marginal information, determine the number of hours from noon that the photo was taken and multiply that number by  $15^\circ$ . With a protractor, measure an angle of that amount in the proper direction (right to left) from a clear, distinct shadow, and north is obtained. For photographs taken within three hours of noon, a reasonable accurate north direction can be obtained. Beyond these limits, the  $15^\circ$  must be corrected, depending on time of year and latitude.

(2) **South Temperate Zone.** The sun moves from east through north at noon to west. Shadows then vary from west through south to east. Before noon, south is to the left of shadow fall; at noon, south is shadow fall; and after noon, south is to the right of shadow fall. Proceed as in (1) above to determine the direction of south.

c. On a photograph that can be oriented to the surrounding ground features by inspection, a magnetic-north line can be established using a compass.

- (1) Orient the photograph by inspection.
- (2) Open the compass and place it on the photograph.
- (3) Without moving the photograph, rotate the compass until the north arrow is under the stationary black line.
- (4) Draw a line along the straight edge of the compass. This is a magnetic-north line.

[Back to Aerial Photographs](#)

Check out the **Amazon Coupons** before you buy.

Copyright © 2001-2002 Jalic LLC. All Rights Reserved.

**[Disclaimer](#) | [Privacy Policy](#) | [Contact Us](#)**



[Orienteering Home](#)

**The Sport:**

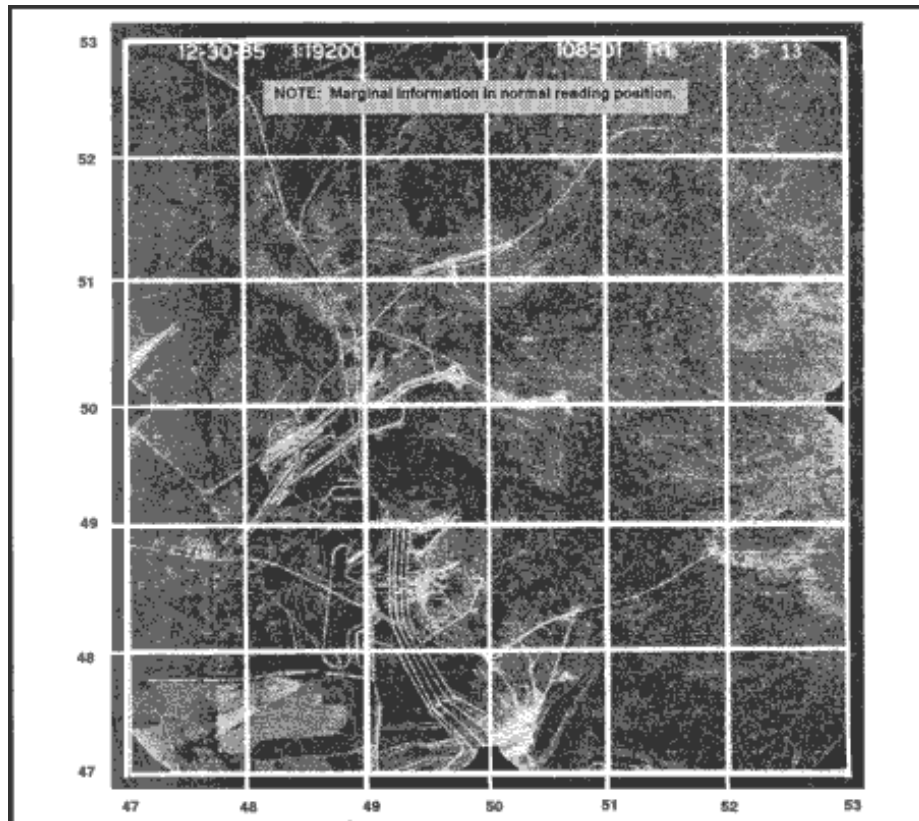
- [Orienteering History](#)
- [Orienteering Overview](#)
- [Course Setup](#)
- [Officials](#)
- [Start/Finish Areas](#)
- [Course Safety](#)
- [Control Point Guidelines](#)
- [Map Symbols](#)
- [Orienteering Techniques](#)
- [Civilian Orienteering](#)

**The Skills:**

- [Maps](#)
- [Marginal Information and Symbols](#)
- [Grids](#)
- [Scale and Distance](#)
- [Direction](#)
- [Overlays](#)
- [Aerial Photographs](#)
- [Navigation](#)
- [Equipment and Methods](#)
- [Elevation and Relief](#)
- [Terrain Association](#)
- [Navigation in Different Types of Terrain](#)
- [Field Sketching](#)
- [Map Folding](#)
- [Techniques](#)
- [Units of Measure and Conversion Factors](#)

## Point Designation Grid

Since aerial photographs are seldom exactly the same scale as a map of the same area, it is not feasible to print military grids on them. A special grid is used for the designation of points on photographs (Figure 8-16). This grid, known as the point designation grid, has no relation to the scale of the photo, to any direction, or to the grid used on any other photograph or map. It has only one purpose, to designate points on photographs.

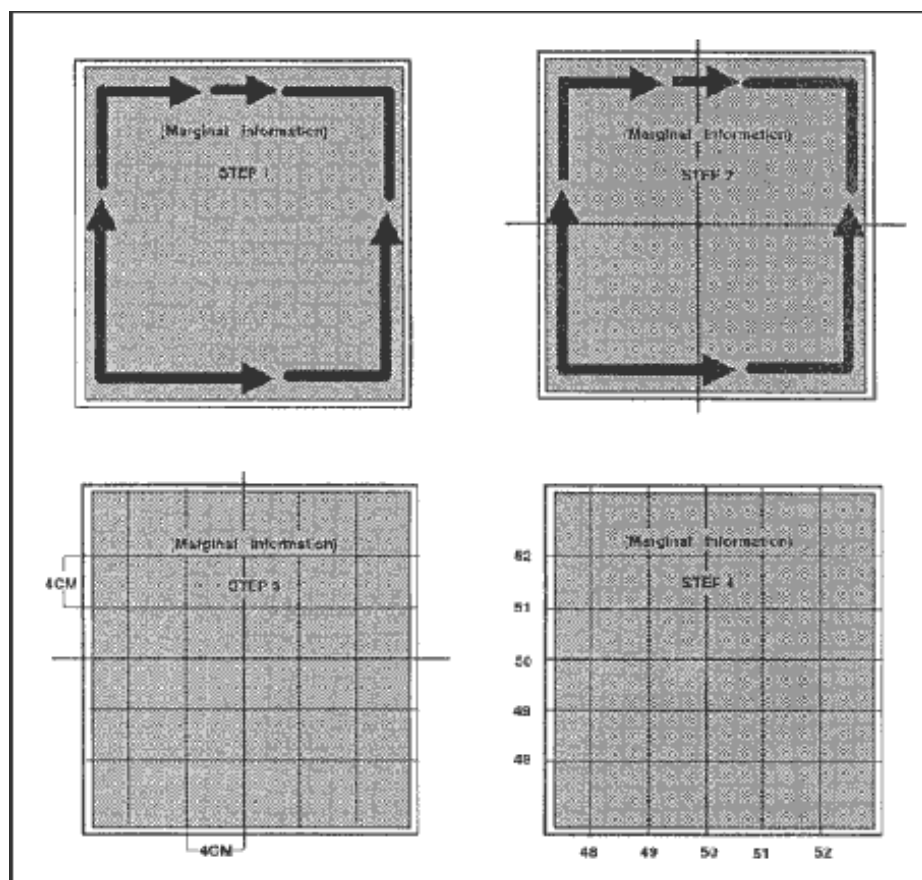


**Figure 8-16. Point designation grid.**

a. The point designation grid is rarely printed on photographs; therefore, it becomes the responsibility of each user to construct the grid on the photograph. All users must construct the grid in exactly the same way. Before the grid can be constructed or used, the photograph must be held so that the marginal information, regardless of where it is located, is in the normal reading position (Figure 8-17, step 1).

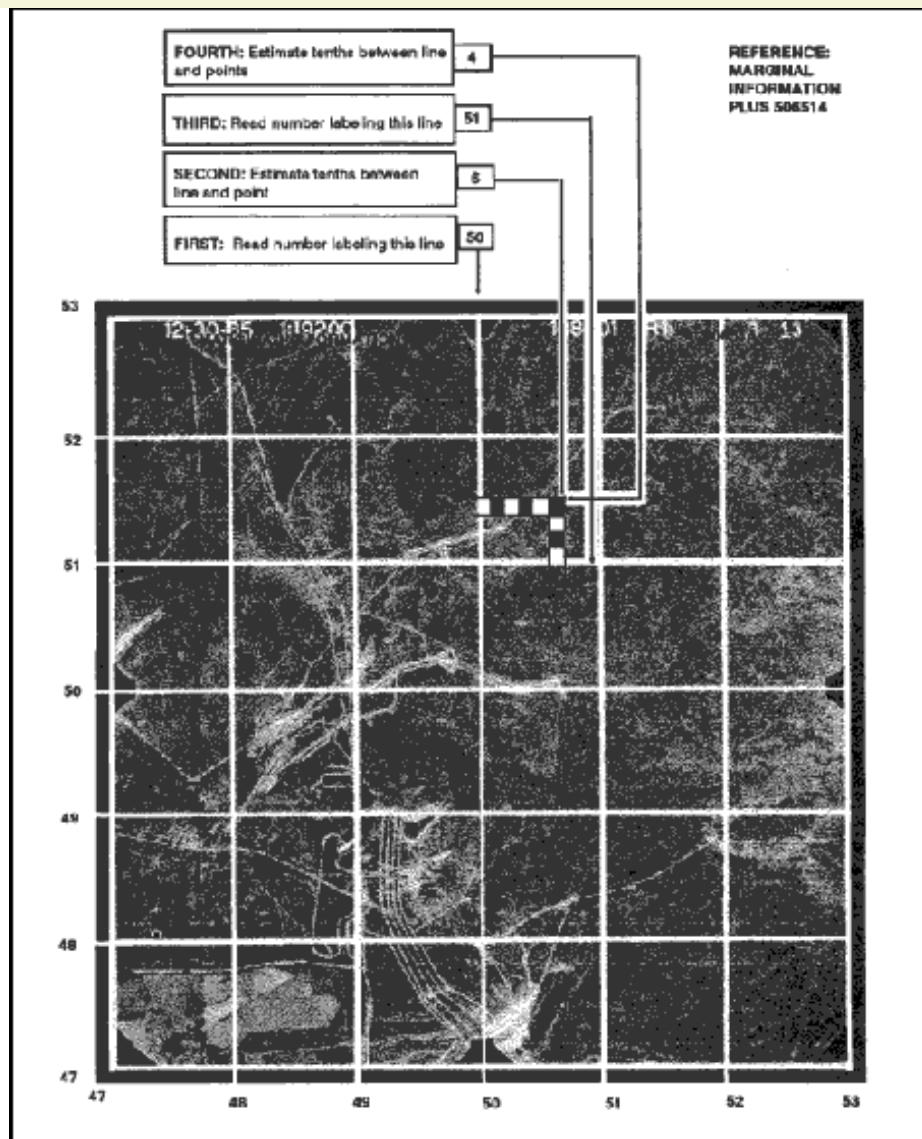


- (1) Draw lines across the photograph joining opposite reference marks at the center of each photograph (fiducial marks). If there are no fiducial marks, the center of each side of the photograph is assumed to be the location of the marks (Figure 8-17, step 2).
- (2) Space grid lines, starting with the center line, 4 centimeters (1.575 inches) apart (a distance equal to 1,000 meters at a scale of 1:25,000). The 1:25,000 map coordinate scale can be used for this dimension and to accurately designate points on the photograph, but this does not mean that distance can be scaled from the photograph. Extend the grid past the margins of the photograph so that a horizontal and vertical grid line fall outside the picture area (Figure 8-17, step 3).
- (3) Number each center line "50" and give numerical values to the remaining horizontal and vertical lines so that they increase to the right and up (Figure 8-17, step 4).



**Figure 8-17. Constructing a point designation grid.**

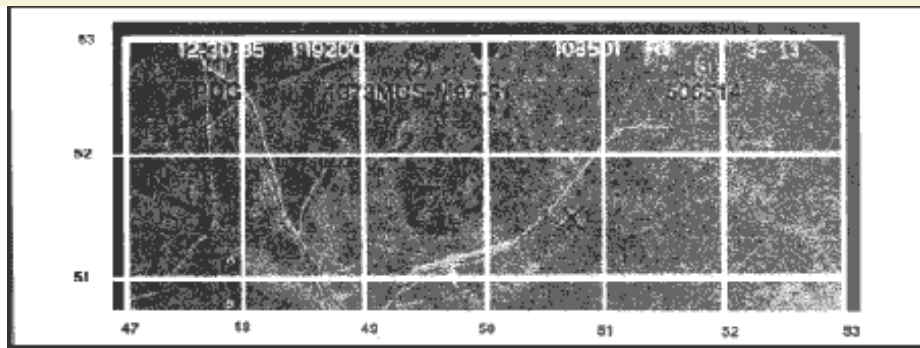
b. The point designation grid is used, once the photograph is oriented, in the same manner as the grid on a map (Figure 8-18), **read right and up**. The coordinate scale used with the UTM grid on maps at the scale of 1:25,000 may be used to subdivide the grid square in the same manner as on a map. However, because the same point designation grid is used on all photographs, the coordinates of a point on the photograph must be prefixed by the identifying marginal information of the photograph.



**Figure 8-18. Reading point designation grid coordinates.**

c. A grid coordinate using the point designation grid (Figure 8-19) consists of three parts:

- (1) The letters "PDG" to indicate an aerial photograph rather than a map grid coordinate.
- (2) The mission and photo negative number to identify which photograph is being used.
- (3) The six numerical digits to locate the actual point on the photograph.



**Figure 8-19. Locating the grid coordinate on a point designation grid.**

[Back to Aerial Photographs](#)

Check out the **Amazon Coupons** before you buy.

Copyright © 2001-2002 Jalic LLC. All Rights Reserved.

[Disclaimer](#) | [Privacy Policy](#) | [Contact Us](#)





[Orienteering Home](#)

## Identification of Photograph Features

### The Sport:

- [Orienteering History](#)
- [Orienteering](#)

### Overview

- [Course Setup](#)
- [Officials](#)
- [Start/Finish Areas](#)
- [Course Safety](#)
- [Control Point](#)

### Guidelines

- [Map Symbols](#)
- [Orienteering](#)

### Techniques

- [Civilian Orienteering](#)

### The Skills:

- [Maps](#)
- [Marginal Information and Symbols](#)
- [Grids](#)
- [Scale and Distance](#)
- [Direction](#)
- [Overlays](#)
- [Aerial Photographs](#)
- [Navigation](#)

### Equipment and

### Methods

- [Elevation and Relief](#)
- [Terrain Association](#)
- [Navigation in](#)

### Different Types of Terrain

- [Field Sketching](#)
- [Map Folding](#)

### Techniques

- [Units of Measure and Conversion Factors](#)

The identification of features on a photograph is not difficult if the following facts are remembered. The view that is presented by the aerial photograph is from above and, as a result, objects do not look familiar. Objects that are greatly reduced in size appear distorted. Most aerial photography is black and white, and all colors appear on the photograph in shades of gray. Generally speaking, the darker the natural color, the darker it will appear on the photograph.

a. The identification of features on aerial photographs depends upon a careful application of five factors of recognition. No one factor will give a positive identification; it requires the use of all five.

(1) **Size**. The size of unknown objects on a photograph, as determined from the scale of the photograph or a comparison with known objects of known size, gives a clue to their identity. For example, in a built-up area the smaller buildings are usually dwellings, and the larger buildings are commercial or community buildings.

(2) **Shape (Pattern)**. Many features possess characteristic shapes that readily identify the features. Man-made features appear as straight or smooth curved lines, while natural features usually appear to be irregular. Some of the most prominent man-made features are highways, railroads, bridges, canals, and buildings. Compare the regular shapes of these to the irregular shapes of such natural features as streams and timber lines.

(3) **Shadows**. Shadows are very helpful in identifying features since they show the familiar side view of the object. Some excellent examples are the shadows of water towers or smoke stacks. As viewed directly from above, only a round circle or dot is seen, whereas the shadow shows the profile and helps to identify the object. Relative lengths of shadows also usually give a good indication of relative heights of objects.

(4) **Shade (Tone or Texture)**. Of the many different types of photographic film in use today, the film used for most aerial photography, except for special purposes, is panchromatic film. Panchromatic film is sensitive to all the colors of the spectrum; it registers them as shades of gray, ranging from white to black. This lighter or darker shade of features on aerial photographs is

known as the tone. The tone is also dependent on the texture of the features; a paved highway has a smooth texture and produces an even tone on the photograph, while a recently plowed field or a marsh has a rough, choppy texture and results in a rough or grainy tone. It is also important to remember that similar features may have different tones on different photographs, depending on the reflection of sunlight. For example, a river or body of water appears light if it is reflecting sunlight directly toward the camera, but appears dark otherwise. Its texture may be smooth or rough, depending on the surface of the water itself. As long as the variables are kept in mind, tone and texture may be used to great advantage.

(5) *Surrounding Objects*. Quite often an object not easily recognized by itself may be identified by its relative position to surrounding objects. Large buildings located beside railroads or railroad sidings are usually factories or warehouses. Identify schools by the baseball or football fields. It would be hard to tell the difference between a water tower next to a railroad station and a silo next to a barn, unless the surrounding objects such as the railroad tracks or cultivated fields were considered.

b. Before a vertical photograph can be studied or used for identification of features, it must be oriented. This orienting is different from the orienting required for the construction or use of the point designation grid. Orienting for study consists of rotating the photograph so that the shadows on the photograph point toward yourself. You then face a source of light. This places the source of light, an object, and its shadow in a natural relationship. Failure to orient a photograph properly may cause the height or depth of an object to appear reversed. For example, a mine or quarry may appear to be a hill instead of a depression.

## Back to Aerial Photographs

Check out the **Amazon Coupons** before you buy.

Copyright © 2001-2002 Jalic LLC. All Rights Reserved.

**Disclaimer | Privacy Policy | Contact Us**



[Orienteering Home](#)

**The Sport:**

- [Orienteering History](#)
- [Orienteering](#)

**Overview**

- [Course Setup](#)
- [Officials](#)
- [Start/Finish Areas](#)
- [Course Safety](#)
- [Control Point](#)

**Guidelines**

- [Map Symbols](#)
- [Orienteering](#)

**Techniques**

- [Civilian Orienteering](#)

**The Skills:**

- [Maps](#)
- [Marginal Information and Symbols](#)

**Grids**

- [Scale and Distance](#)
- [Direction](#)
- [Overlays](#)

**Aerial Photographs**

- [Navigation](#)

**Equipment and**

**Methods**

- [Elevation and Relief](#)
- [Terrain Association](#)
- [Navigation in](#)

**Different Types of Terrain**

- [Field Sketching](#)

- [Map Folding](#)

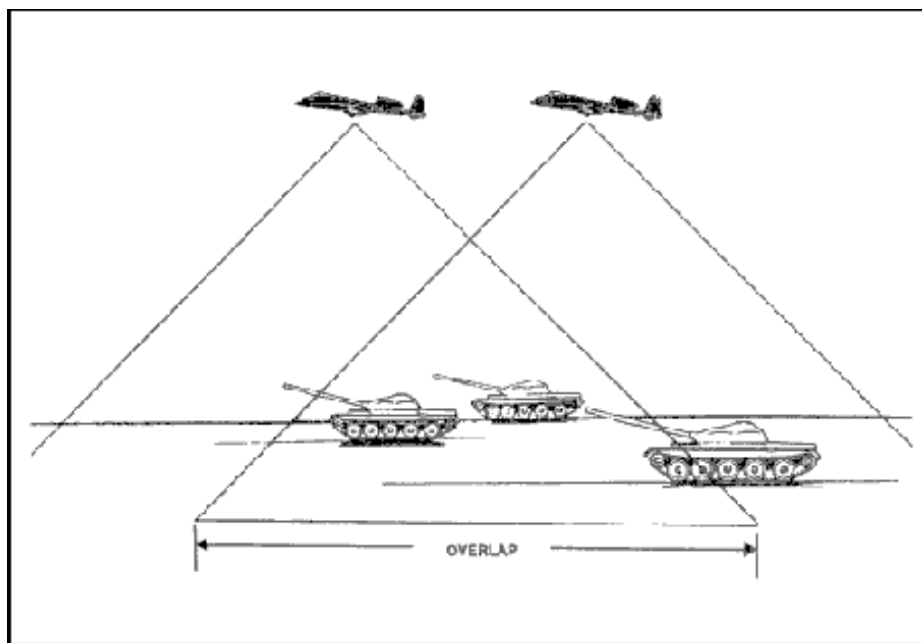
**Techniques**

- [Units of Measure and Conversion Factors](#)

## Stereovision

One of the limitations of the vertical aerial photograph is the lack of apparent relief. Stereoscopic vision (or as it is more commonly known, stereovision or depth perception) is the ability to see three-dimensionally or to see length, width, and depth (distance) at the same time. This requires two views of a single object from two slightly different positions. Most people have the ability to see three-dimensionally. Whenever an object is viewed, it is seen twice--once with the left eye and once with the right eye. The fusion or blending together of these two images in the brain permits the judgment of depth or distance.

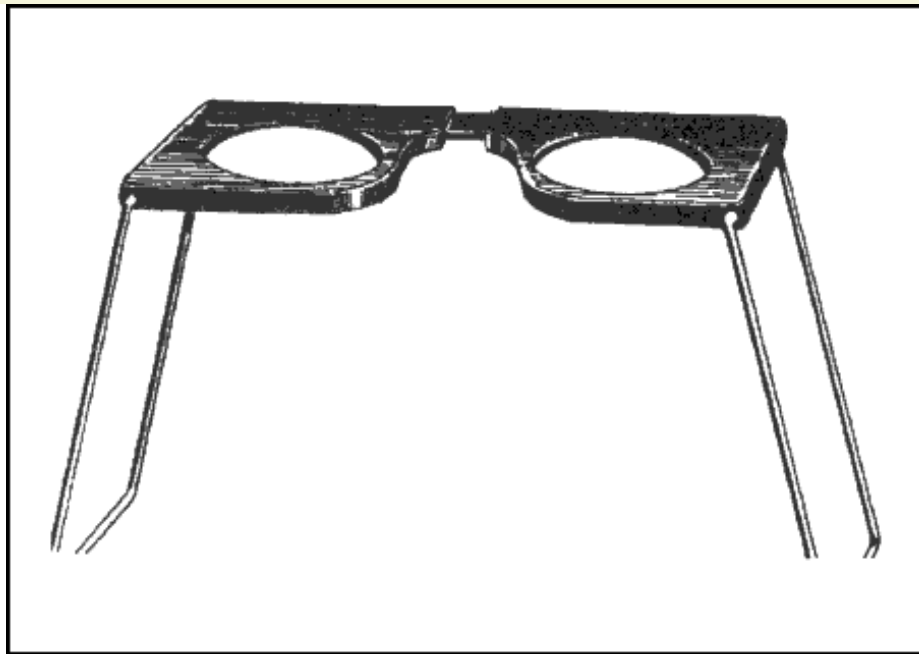
- a. In taking aerial photographs, it is rare for only a single picture to be taken. Generally, the aircraft flies over the area to be photographed taking a series of pictures, each of which overlaps the photograph preceding it and the photograph following it so that an unbroken coverage of the area is obtained (Figure 8-20). The amount of overlap is usually 56 percent, which means that 56 percent of the ground detail appearing on one photo also appears on the next photograph. When a single flight does not give the necessary coverage of an area, additional flights must be made. These additional flights are parallel to the first and must have an overlap between them. This overlap between flights is known as side lap and usually is between 15 and 20 percent (Figure 8-21).



**Figure 8-20. Photographic overlap.****Figure 8-21. Side lap.**

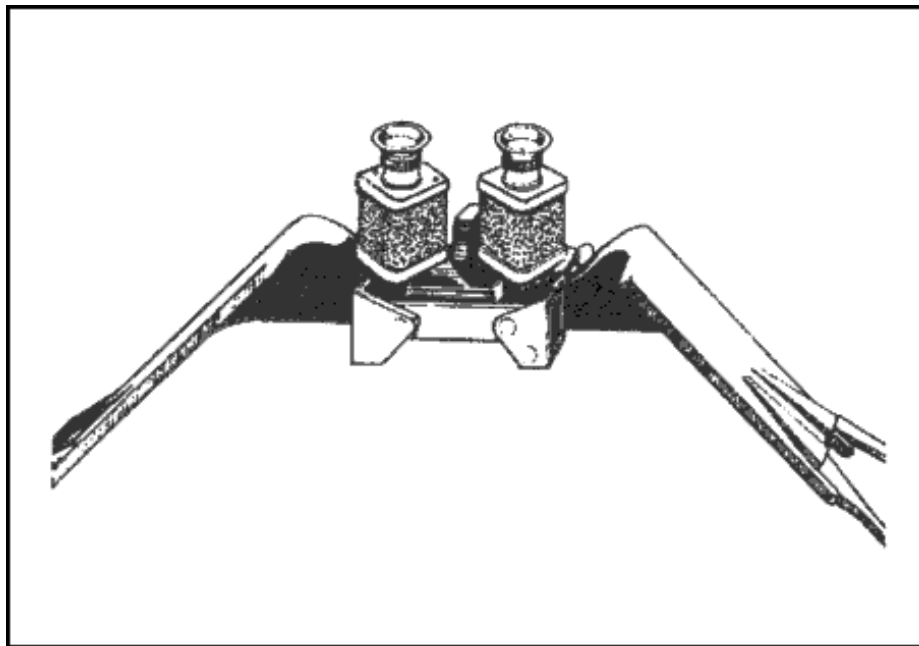
b. The requirement for stereovision can be satisfied by overlapping photographs if one eye sees the object on one photograph and the other eye sees the same object on another photograph. While this can be done after practice with the eyes alone, it is much easier if an optical aid is used. These optical aids are known as stereoscopes. There are many types of stereoscopes, but only the two most commonly used are discussed in this manual.

(1) **Pocket Stereoscope.** The pocket stereoscope (Figure 8-22), sometimes known as a lens stereoscope, consists of two magnifying lenses mounted in a metal frame. Because of its simplicity and ease of carrying, it is the type used most frequently by military personnel.



**Figure 8-22. Pocket stereoscope.**

(2) *Mirror Stereoscope*. The mirror stereoscope (Figure 8-23) is larger, heavier, and more subject to damage than the pocket stereoscope. It consists of four mirrors mounted in a metal frame.

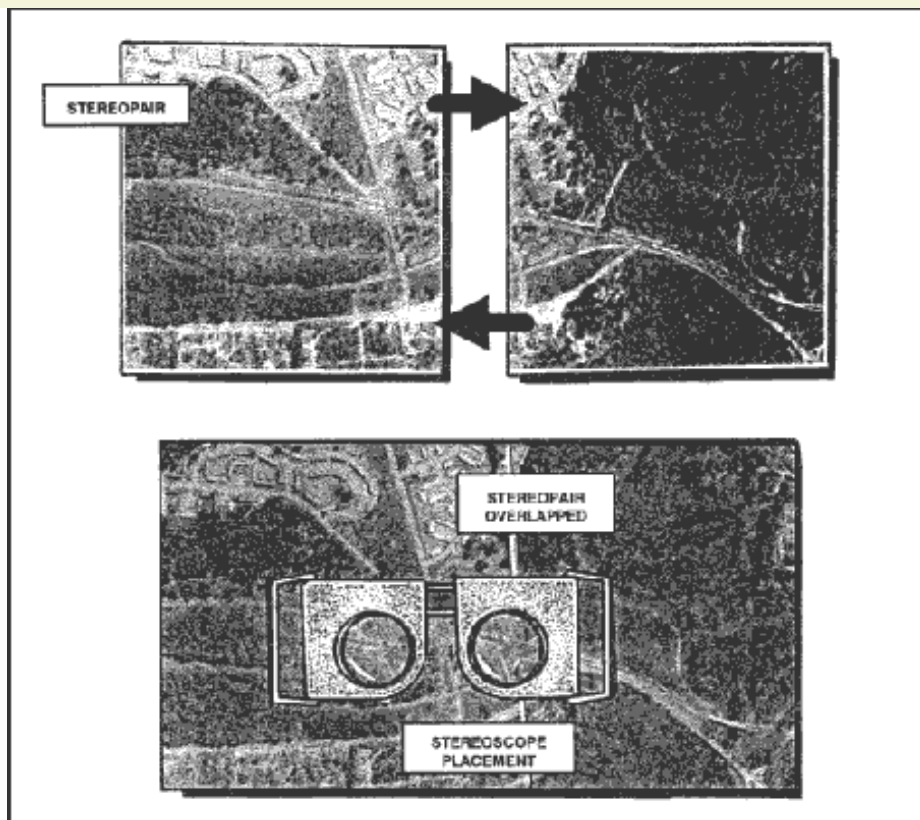


**Figure 8-23. Mirror stereoscope.**

c. A method to orient a pair of aerial photographs for best three-dimensional viewing is outlined below:

(1) Arrange the selected pair of photos in such a way that the shadows on them generally appear to fall toward the viewer. It is also desirable that the light source enters the side away from the observer during the study of the photographs (Figure 8-24).





**Figure 8-24. Placement of stereoscope over stereopair.**

- (2) Place the pair of photographs on a flat surface so that the detail on one photograph is directly over the same detail on the other photograph (Figure 8-24).
- (3) Place the stereoscope over the photographs so that the left lens is over the left photograph and the right lens is over the right photograph (Figure 8-24).
- (4) Separate the photographs along the line of flight until a piece of detail appearing in the overlap area of the left photograph is directly under the left lens and the same piece of detail on the right photo is directly under the right lens.
- (5) With the photograph and stereoscope in this position, a three-dimensional image should be seen. A few minor adjustments may be necessary, such as adjusting the aerial photographs of the stereoscope to obtain the correct position for your eyes. The hills appear to rise and the valleys sink so that there is the impression of being in an aircraft looking down at the ground.
- (6) The identification of features on photographs is much easier and more accurate with this three-dimensional view. The same five factors of recognition (size, shape, shadow, tone, and surrounding objects) must still be applied; but now, with the addition of relief, a more natural view is seen.

[Back to Aerial Photographs](#)



Check out the **Amazon Coupons** before you buy.

Copyright © 2001-2002 Jalic LLC. All Rights Reserved.

**[Disclaimer](#) | [Privacy Policy](#) | [Contact Us](#)**



Orienteering Home

The Sport:

- Orienteering History
- Orienteering Overview
- Course Setup
- Officials
- Start/Finish Areas
- Course Safety
- Control Point Guidelines
- Map Symbols
- Orienteering Techniques
- Civilian Orienteering

The Skills:

- Maps
- Marginal Information and Symbols
- Grids
- Scale and Distance
- Direction
- Overlays
- Aerial Photographs
- Navigation Equipment and Methods
- Elevation and Relief
- Terrain Association
- Navigation in Different Types of Terrain
- Field Sketching
- Map Folding Techniques
- Units of Measure and Conversion Factors

## Types of Compasses

The **lensatic compass** is the most common and simplest instrument for measuring direction. It is discussed in detail below. The **wrist/pocket compass** is a small magnetic compass that can be attached to a wristwatch band. It contains a north-seeking arrow and a dial in degrees. A **protractor** can be used to determine azimuths when a compass is not available. However, it should be noted that when using the protractor on a map, only grid azimuths are obtained.

### 9-2. LENSATIC COMPASS

The lensatic compass (Figure 9-1) consists of three major parts: the cover, the base, and the lens.

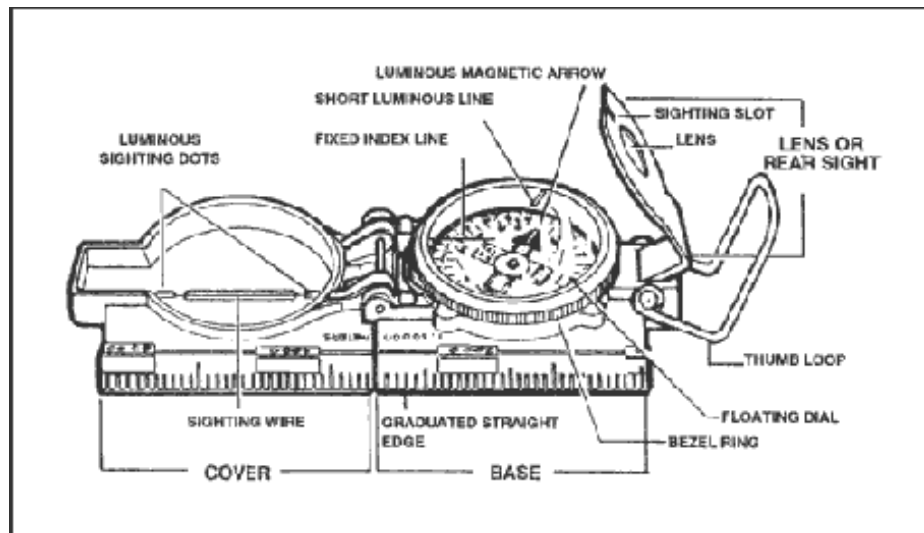


Figure 9-1. Lensatic compass.

- a. **Cover.** The compass cover protects the floating dial. It contains the sighting wire (front sight) and two luminous sighting slots or dots used for night navigation.
- b. **Base.** The body of the compass contains the following movable parts:
  - (1) The floating dial is mounted on a pivot so it can rotate freely when the compass is held level. Printed on the dial in luminous figures are an arrow and the letters E and W. The arrow always points to magnetic north and the letters fall at east (E) 90° and

west (W) 270° on the dial. There are two scales; the outer scale denotes mils and the inner scale (normally in red) denotes degrees.

(2) Encasing the floating dial is a glass containing a fixed black index line.

(3) The bezel ring is a ratchet device that clicks when turned. It contains 120 clicks when rotated fully; each click is equal to 3°. A short luminous line that is used in conjunction with the north-seeking arrow during navigation is contained in the glass face of the bezel ring.

(4) The thumb loop is attached to the base of the compass.

c. **Lens.** The lens is used to read the dial, and it contains the rear-sight slot used in conjunction with the front for sighting on objects. The rear sight also serves as a lock and clamps the dial when closed for its protection. The rear sight must be opened more than 45° to allow the dial to float freely.

**NOTE:** When opened, the straightedge on the left side of the compass has a coordinate scale; the scale is 1:50,000 in newer compasses.

#### WARNING

**Some older compasses will have a 1:25,000 scale. This scale can be used with a 1:50,000-scale map, but the values read must be halved. Check the scale.**

[Back to Navigation Equipment and Methods](#)

Check out the **Amazon Coupons** before you buy.

Copyright © 2001-2002 Jalic LLC. All Rights Reserved.

[Disclaimer](#) | [Privacy Policy](#) | [Contact Us](#)



[Orienteering Home](#)

**The Sport:**

- [Orienteering History](#)
- [Orienteering](#)

**Overview**

- [Course Setup](#)
- [Officials](#)
- [Start/Finish Areas](#)
- [Course Safety](#)
- [Control Point](#)

**Guidelines**

- [Map Symbols](#)
- [Orienteering](#)

**Techniques**

- [Civilian Orienteering](#)

**The Skills:**

- [Maps](#)
- [Marginal Information and Symbols](#)
- [Grids](#)
- [Scale and Distance](#)
- [Direction](#)
- [Overlays](#)
- [Aerial Photographs](#)
- [Navigation](#)

**Equipment and**

**Methods**

- [Elevation and Relief](#)
- [Terrain Association](#)
- [Navigation in](#)

**Different Types of Terrain**

- [Field Sketching](#)
- [Map Folding](#)

**Techniques**

- [Units of Measure and](#)

**Conversion Factors**

## Compass Handling

Compasses are delicate instruments and should be cared for accordingly.

a. **Inspection.** A detailed inspection is required when first obtaining and using a compass. One of the most important parts to check is the floating dial, which contains the magnetic needle. The user must also make sure the sighting wire is straight, the glass and crystal parts are not broken, the numbers on the dial are readable, and most important, that the dial does not stick.

b. **Effects of Metal and Electricity.** Metal objects and electrical sources can affect the performance of a compass. However, nonmagnetic metals and alloys do not affect compass readings. The following separation distances are suggested to ensure proper functioning of a compass:

High-tension power lines .....	55 meters.
Field gun, truck, or tank .....	18 meters.
Telegraph or telephone wires and barbed wire .....	10 meters.
Machine gun .....	2 meters.
Steel helmet or rifle .....	1/2 meter.

c. **Accuracy.** A compass in good working condition is very accurate. However, a compass has to be checked periodically on a known line of direction, such as a surveyed azimuth using a declination station. Compasses with more than 3° + variation should not be used.

d. **Protection.** If traveling with the compass unfolded, make sure the rear sight is fully folded down onto the bezel ring. This will lock the floating dial and prevent vibration, as well as protect the crystal and rear sight from damage.

[Back to Navigation Equipment and Methods](#)

Check out the **Amazon Coupons** before you buy.

Copyright © 2001-2002 Jalic LLC. All Rights Reserved.  
**[Disclaimer](#) | [Privacy Policy](#) | [Contact Us](#)**



# Orienteeing

## Orienteeing Home

### The Sport:

- Orienteeing History
- Orienteeing

### Overview

- Course Setup
- Officials
- Start/Finish Areas
- Course Safety
- Control Point

### Guidelines

- Map Symbols
- Orienteeing

### Techniques

- Civilian Orienteeing

### The Skills:

- Maps
- Marginal Information and Symbols

- Grids
- Scale and Distance
- Direction
- Overlays
- Aerial Photographs

### Navigation

### Equipment and

### Methods

- Elevation and Relief
- Terrain Association
- Navigation in

### Different Types of Terrain

- Field Sketching
- Map Folding

### Techniques

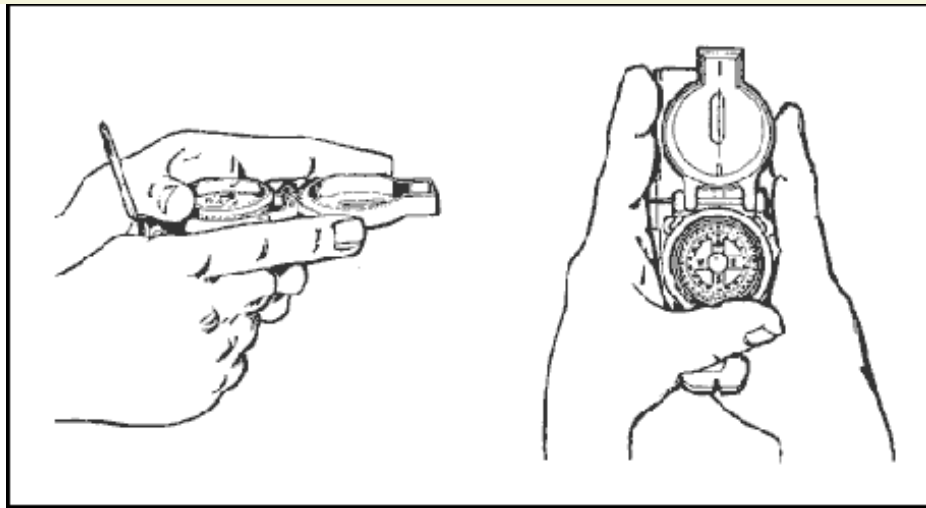
- Units of Measure and Conversion Factors

## Using a Compass

Magnetic azimuths are determined with the use of magnetic instruments, such as lensatic and M2 compasses. The techniques employed when using the lensatic compass are as follows:

- a. **Using the Centerhold Technique.** First, open the compass to its fullest so that the cover forms a straightedge with the base. Move the lens (rear sight) to the rearmost position, allowing the dial to float freely. Next, place your thumb through the thumb loop, form a steady base with your third and fourth fingers, and extend your index finger along the side of the compass. Place the thumb of the other hand between the lens (rear sight) and the bezel ring; extend the index finger along the remaining side of the compass, and the remaining fingers around the fingers of the other hand. Pull your elbows firmly into your sides; this will place the compass between your chin and your belt. To measure an azimuth, simply turn your entire body toward the object, pointing the compass cover directly at the object. Once you are pointing at the object, look down and read the azimuth from beneath the fixed black index line (Figure 9-2). This preferred method offers the following advantages over the sighting technique:
  - (1) It is faster and easier to use.
  - (2) It can be used under all conditions of visibility.
  - (3) It can be used when navigating over any type of terrain.
  - (4) It can be used without putting down the rifle; however, the rifle must be slung well back over either shoulder.
  - (5) It can be used without removing eyeglasses.

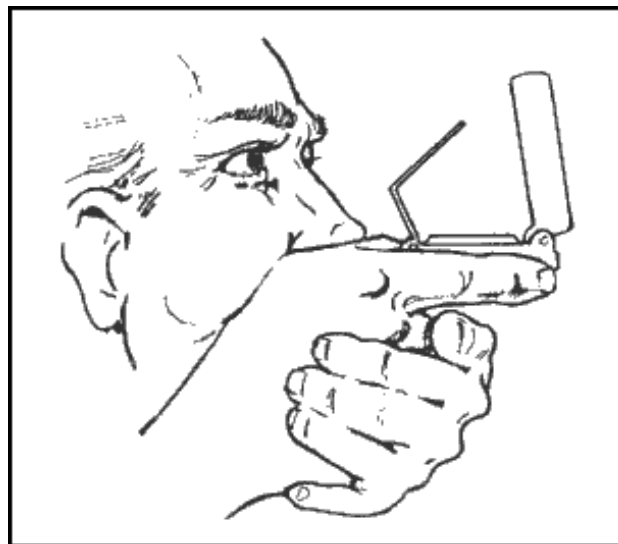




**Figure 9-2. Centerhold technique.**

b. **Using the Compass-to-Cheek Technique.** Fold the cover of the compass containing the sighting wire to a vertical position; then fold the rear sight slightly forward. Look through the rear-sight slot and align the front-sight hairline with the desired object in the distance. Then glance down at the dial through the eye lens to read the azimuth (Figure 9-3).

**NOTE:** The compass-to-cheek technique is used almost exclusively for sighting, and it is the best technique for this purpose.

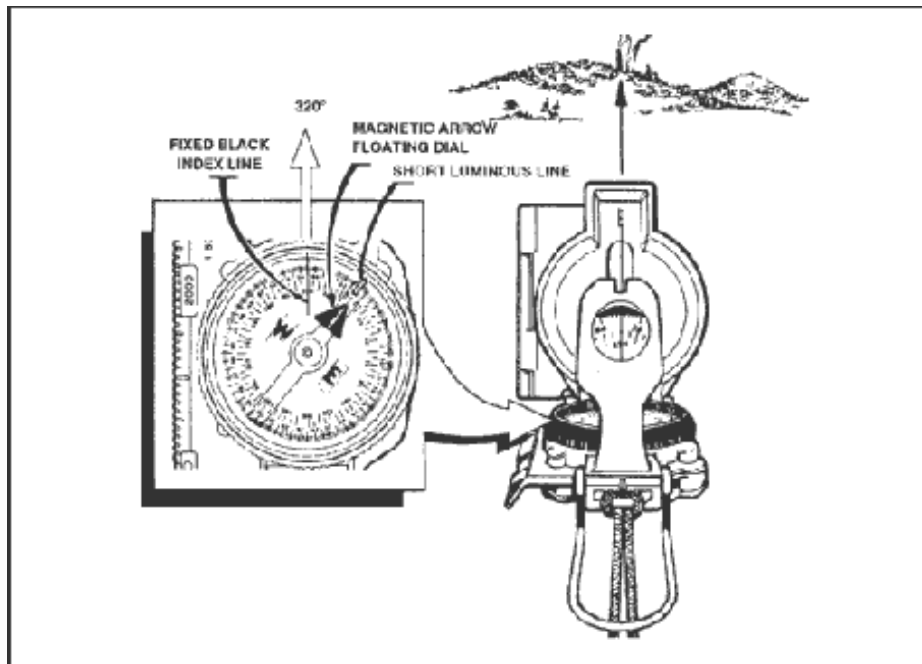


**Figure 9-3. Compass-to-cheek technique.**

c. **Presetting a Compass and Following an Azimuth.** Although different models of the lensatic compass vary somewhat in the details of their use, the principles are the same.

- (1) During daylight hours or with a light source:
  - (a) Hold the compass level in the palm of the hand.
  - (b) Rotate it until the desired azimuth falls under the fixed

black index line (for example, 320°), maintaining the azimuth as prescribed (Figure 9-4).



**Figure 9-4. Compass preset at 320 degrees.**

(c) Turn the bezel ring until the luminous line is aligned with the north-seeking arrow. Once the alignment is obtained, the compass is preset.

(d) To follow an azimuth, assume the centerhold technique and turn your body until the north-seeking arrow is aligned with the luminous line. Then proceed forward in the direction of the front cover's sighting wire, which is aligned with the fixed black index line that contains the desired azimuth.

(2) During limited visibility, an azimuth may be set on the compass by the click method. Remember that the bezel ring contains 3° intervals (clicks).

(a) Rotate the bezel ring until the luminous line is over the fixed black index line.

(b) Find the desired azimuth and divide it by three. The result is the number of clicks that you have to rotate the bezel ring.

(c) Count the desired number of clicks. If the desired azimuth is smaller than 180°, the number of clicks on the bezel ring should be counted in a counterclockwise direction. For example, the desired azimuth is 51°. Desired azimuth is 51°,  $3 = 17$  clicks counterclockwise. If the desired azimuth is larger than 180°, subtract the number of degrees from 360° and divide by 3 to obtain the number of clicks. Count them in a clockwise direction. For example, the desired azimuth is 330°;  $360^\circ - 330^\circ = 30$ ,  $3 = 10$  clicks

clockwise.

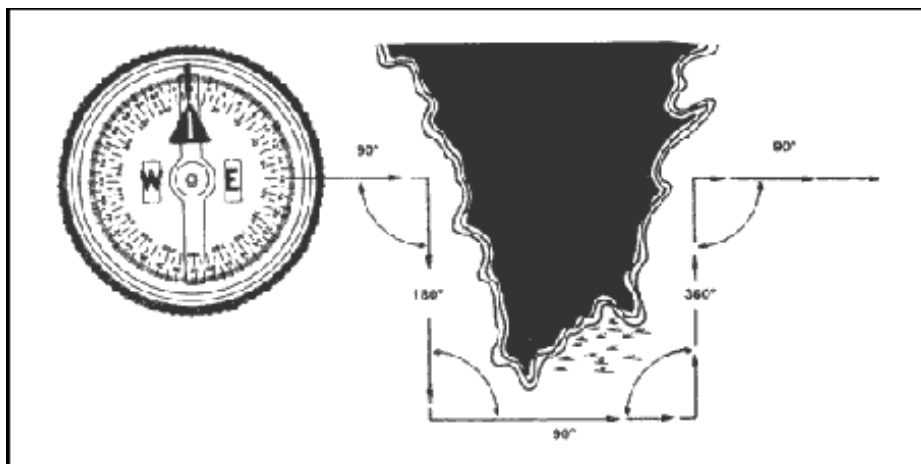
(d) With the compass preset as described above, assume a centerhold technique and rotate your body until the north-seeking arrow is aligned with the luminous line on the bezel. Then proceed forward in the direction of the front cover's luminous dots, which are aligned with the fixed black index line containing the azimuth.

(e) When the compass is to be used in darkness, an initial azimuth should be set while light is still available, if possible. With the initial azimuth as a base, any other azimuth that is a multiple of three can be established through the use of the clicking feature of the bezel ring.

**NOTE:** Sometimes the desired azimuth is not exactly divisible by three, causing an option of rounding up or rounding down. If the azimuth is rounded up, this causes an increase in the value of the azimuth, and the object is to be found on the left. If the azimuth is rounded down, this causes a decrease in the value of the azimuth, and the object is to be found on the right.

d. **Bypassing an Obstacle.** To bypass enemy positions or obstacles and still stay oriented, detour around the obstacle by moving at right angles for specified distances.

(1) For example, while moving on an azimuth of  $90^\circ$  change your azimuth to  $180^\circ$  and travel for 100 meters. Change your azimuth to  $90^\circ$  and travel for 150 meters. Change your azimuth to  $360^\circ$  and travel for 100 meters. Then, change your azimuth to  $90^\circ$  and you are back on your original azimuth line (Figure 9-5).

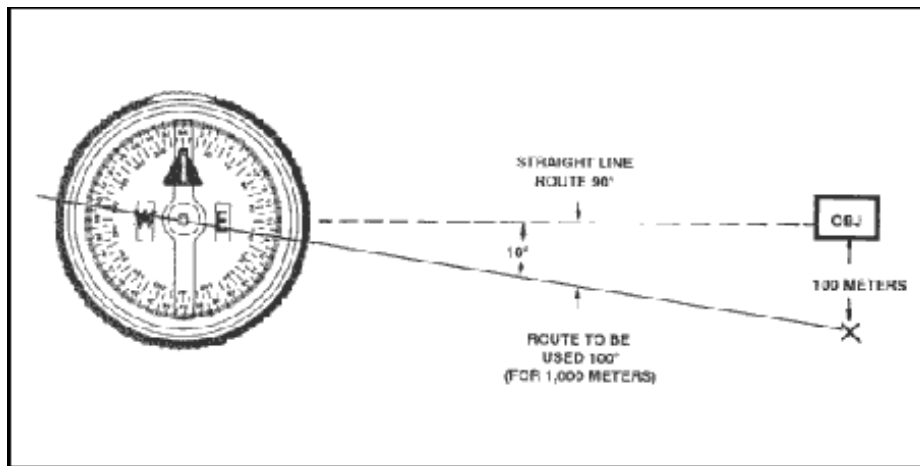


**Figure 9-5. Bypassing an obstacle.**

(2) Bypassing an unexpected obstacle at night is a fairly simple matter. To make a  $90^\circ$  turn to the right, hold the compass in the centerhold technique; turn until the center of the luminous letter E is under the luminous line (*do not* move the bezel ring). To make a  $90^\circ$  turn to the left, turn until the center of the luminous letter W is under the luminous line. This does not require changing the

compass setting (bezel ring), and it ensures accurate 90° turns.

e. **Offset.** A deliberate offset is a planned magnetic deviation to the right or left of an azimuth to an objective. Use it when the objective is located along or in the vicinity of a linear feature such as a road or stream. Because of errors in the compass or in map reading, the linear feature may be reached without knowing whether the objective lies to the right or left. A deliberate offset by a known number of degrees in a known direction compensates for possible errors and ensures that upon reaching the linear feature, the user knows whether to go right or left to reach the objective. Ten degrees is an adequate offset for most tactical uses. Each degree offset moves the course about 18 meters to the right or left for each 1,000 meters traveled. For example, in Figure 9-6, the number of degrees offset is 10. If the distance traveled to "x" in 1,000 meters, then "x" is located about 180 meters to the right of the objective.



**Figure 9-6. Deliberate offset to the objective.**

[Back to Navigation Equipment and Methods](#)

Check out the **Amazon Coupons** before you buy.

Copyright © 2001-2002 Jalic LLC. All Rights Reserved.

**Disclaimer | Privacy Policy | Contact Us**



[Orienteering Home](#)

**The Sport:**

- [Orienteering History](#)
- [Orienteering](#)

**Overview**

- [Course Setup](#)
- [Officials](#)
- [Start/Finish Areas](#)
- [Course Safety](#)
- [Control Point](#)

**Guidelines**

- [Map Symbols](#)
- [Orienteering](#)

**Techniques**

- [Civilian Orienteering](#)

**The Skills:**

- [Maps](#)
- [Marginal Information and Symbols](#)

- [Grids](#)
- [Scale and Distance](#)
- [Direction](#)
- [Overlays](#)

- [Aerial Photographs](#)
- [Navigation](#)

**Equipment and Methods**

- [Elevation and Relief](#)
- [Terrain Association](#)
- [Navigation in](#)

**Different Types of Terrain**

- [Field Sketching](#)
- [Map Folding](#)

**Techniques**

- [Units of Measure and Conversion Factors](#)

## Global Positioning System

The GPS is a space-based, global, all-weather, continuously available, radio positioning navigation system. It is highly accurate in determining position location derived from signal triangulation from a satellite constellation system. It is capable of determining latitude, longitude, and altitude of the individual user. It is being fielded in hand-held, manpack, vehicular, aircraft, and watercraft configurations. The GPS receives and processes data from satellites on either a simultaneous or sequential basis. It measures the velocity and range with respect to each satellite, processes the data in terms of an earth-centered, earth-fixed coordinate system, and displays the information to the user in geographic or military grid coordinates.

a. The GPS can provide precise steering information, as well as position location. The receiver can accept many checkpoints entered in any coordinate system by the user and convert them to the desired coordinate system. The user then calls up the desired checkpoint and the receiver will display direction and distance to the checkpoint. The GPS does not have inherent drift, an improvement over the Inertial Navigation System, and the receiver will automatically update its position. The receiver can also compute time to the next checkpoint.

b. Specific uses for the GPS are position location; navigation; weapon location; target and sensor location; coordination of firepower; scout and screening operations; combat resupply; location of obstacles, barriers, and gaps; and communication support. The GPS also has the potential to allow units to train their soldiers and provide the following:

- Performance feedback.
- Knowledge of routes taken by the soldier.
- Knowledge of errors committed by the soldier.
- Comparison of planned versus executed routes.
- Safety and control of lost and injured soldiers.

[Back to Navigation Equipment and Methods](#)

Check out the **Amazon Coupons** before you buy.

Copyright © 2001-2002 Jalic LLC. All Rights Reserved.

**[Disclaimer](#) | [Privacy Policy](#) | [Contact Us](#)**





[Orienteering Home](#)

## Definitions

The Sport:

- [Orienteering History](#)
- [Orienteering](#)

**Overview**

- [Course Setup](#)
- [Officials](#)
- [Start/Finish Areas](#)
- [Course Safety](#)
- [Control Point](#)

**Guidelines**

- [Map Symbols](#)
- [Orienteering](#)

**Techniques**

- [Civilian Orienteering](#)

The reference or start point for vertical measurement of elevation on a standard military map are the datum plane or mean sea level, the point halfway between high tide and low tide. Elevation of a point on the earth's surface is the vertical distance it is above or below mean sea level. Relief is the representation (as depicted by the mapmaker) of the shapes of hills, valleys, streams, or terrain features on the earth's surface.

[Back to Elevation and Relief](#)

The Skills:

- [Maps](#)
- [Marginal Information and Symbols](#)

- [Grids](#)
- [Scale and Distance](#)
- [Direction](#)

- [Overlays](#)
- [Aerial Photographs](#)
- [Navigation](#)

**Equipment and**

- [Methods](#)
- [Elevation and Relief](#)
- [Terrain Association](#)
- [Navigation in](#)

**Different Types of Terrain**

- [Field Sketching](#)
- [Map Folding](#)

**Techniques**

- [Units of Measure and Conversion Factors](#)

Check out the [Amazon Coupons](#) before you buy.

Copyright © 2001-2002 Jalic LLC. All Rights Reserved.

[Disclaimer](#) | [Privacy Policy](#) | [Contact Us](#)





## Methods of Depicting Relief

Mapmakers use several methods to depict relief of the terrain.

- a. **Layer Tinting.** Layer tinting is a method of showing relief by color. A different color is used for each band of elevation. Each shade of color, or band, represents a definite elevation range. A legend is printed on the map margin to indicate the elevation range represented by each color. However, this method does not allow the map user to determine the exact elevation of a specific point—only the range.
- b. **Form Lines.** Form lines are not measured from any datum plane. Form lines have no standard elevation and give only a general idea of relief. Form lines are represented on a map as dashed lines and are never labeled with representative elevations.
- c. **Shaded Relief.** Relief shading indicates relief by a shadow effect achieved by tone and color that results in the darkening of one side of terrain features, such as hills and ridges. The darker the shading, the steeper the slope. Shaded relief is sometimes used in conjunction with contour lines to emphasize these features.
- d. **Hachures.** Hachures are short, broken lines used to show relief. Hachures are sometimes used with contour lines. They do not represent exact elevations, but are mainly used to show large, rocky outcrop areas. Hachures are used extensively on small-scale maps to show mountain ranges, plateaus, and mountain peaks.
- e. **Contour Lines.** Contour lines are the most common method of showing relief and elevation on a standard topographic map. A contour line represents an imaginary line on the ground, above or below sea level. All points on the contour line are at the same elevation. The elevation represented by contour lines is the vertical distance above or below sea level. The three types of contour lines (Figure 10-1) used on a standard topographic map are as follows:

[Orienteering Home](#)

The Sport:

- [Orienteering History](#)
- [Orienteering Overview](#)
- [Course Setup](#)
- [Officials](#)
- [Start/Finish Areas](#)
- [Course Safety](#)
- [Control Point](#)

Guidelines

- [Map Symbols](#)
- [Orienteering](#)

Techniques

- [Civilian Orienteering](#)

The Skills:

- [Maps](#)
- [Marginal Information and Symbols](#)
- [Grids](#)
- [Scale and Distance](#)
- [Direction](#)
- [Overlays](#)
- [Aerial Photographs](#)
- [Navigation](#)

Equipment and Methods

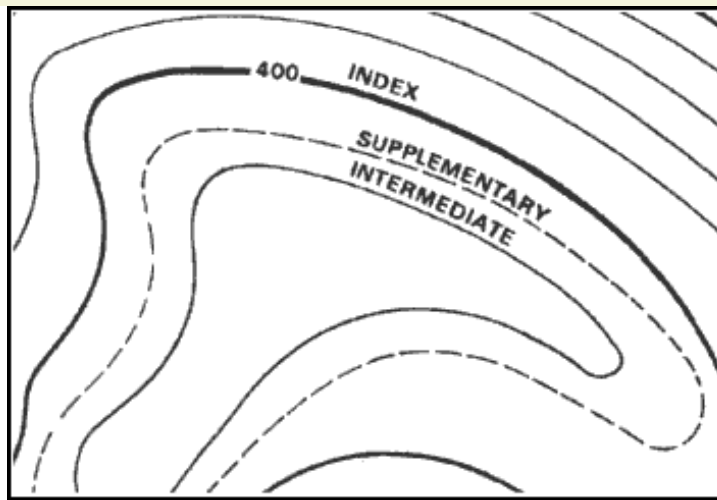
- [Elevation and Relief](#)
- [Terrain Association](#)
- [Navigation in](#)

Different Types of Terrain

- [Field Sketching](#)
- [Map Folding](#)

Techniques

- [Units of Measure and Conversion Factors](#)



**Figure 10-1. Contour lines.**

- (1) ***Index.*** Starting at zero elevation or mean sea level, every fifth contour line is a heavier line. These are known as index contour lines. Normally, each index contour line is numbered at some point. This number is the elevation of that line.
- (2) ***Intermediate.*** The contour lines falling between the index contour lines are called intermediate contour lines. These lines are finer and do not have their elevations given. There are normally four intermediate contour lines between index contour lines.
- (3) ***Supplementary.*** These contour lines resemble dashes. They show changes in elevation of at least one-half the contour interval. These lines are normally found where there is very little change in elevation, such as on fairly level terrain.

## Back to Elevation and Relief

Check out the **Amazon Coupons** before you buy.

Copyright © 2001-2002 Jalic LLC. All Rights Reserved.

**Disclaimer | Privacy Policy | Contact Us**



[Orienteering Home](#)

**The Sport:**

- [Orienteering History](#)

- [Orienteering](#)

**Overview**

- [Course Setup](#)

- [Officials](#)

- [Start/Finish Areas](#)

- [Course Safety](#)

- [Control Point](#)

**Guidelines**

- [Map Symbols](#)

- [Orienteering](#)

**Techniques**

- [Civilian Orienteering](#)

**The Skills:**

- [Maps](#)

- [Marginal Information and Symbols](#)

- [Grids](#)

- [Scale and Distance](#)

- [Direction](#)

- [Overlays](#)

- [Aerial Photographs](#)

- [Navigation](#)

**Equipment and Methods**

- [Elevation and Relief](#)

- [Terrain Association](#)

- [Navigation in](#)

**Different Types of Terrain**

- [Field Sketching](#)

- [Map Folding](#)

**Techniques**

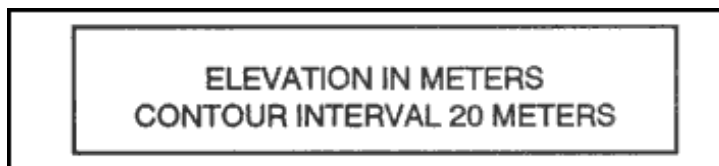
- [Units of Measure and](#)

- [Conversion Factors](#)

## Contour Intervals

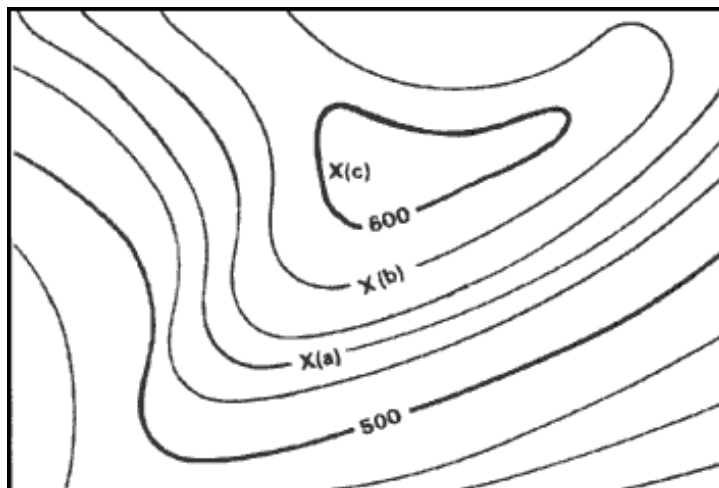
Before the elevation of any point on the map can be determined, the user must know the contour interval for the map he is using. The contour interval measurement given in the marginal information is the vertical distance between adjacent contour lines. To determine the elevation of a point on the map—

- Determine the contour interval and the unit of measure used, for example, feet, meters, or yards (Figure 10-2).



**Figure 10-2. Contour interval note.**

- Find the numbered index contour line nearest the point of which you are trying to determine the elevation (Figure 10-3).



**Figure 10-3. Points on contour lines.**

- Determine if you are going from lower elevation to higher, or vice versa. In Figure 10-3, point (a) is between the index contour lines. The lower index contour line is numbered 500, which means any point on that line is at an elevation of 500 meters above mean sea level. The

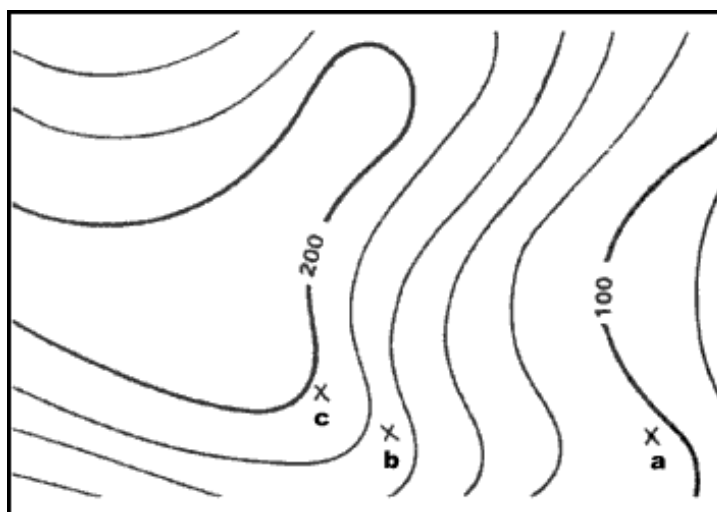
upper index contour line is numbered 600, or 600 meters. Going from the lower to the upper index contour line shows an increase in elevation.

d. Determine the exact elevation of point (a), start at the index contour line numbered 500 and count the number of intermediate contour lines to point (a). Locate point (a) on the second intermediate contour line above the 500-meter index contour line. The contour interval is 20 meters (Figure 10-2), thus each one of the intermediate contour lines crossed to get to point (a) adds 20 meters to the 500-meter index contour line. The elevation of point (a) is 540 meters; the elevation has increased.

e. Determine the elevation of point (b). Go to the nearest index contour line. In this case, it is the upper index contour line numbered 600. Locate point (b) on the intermediate contour line immediately below the 600-meter index contour line. Below means downhill or a lower elevation. Therefore, point (b) is located at an elevation of 580 meters. Remember, if you are increasing elevation, add the contour interval to the nearest index contour line. If you are decreasing elevation, subtract the contour interval from the nearest index contour line.

f. Determine the elevation to a hilltop point (c). Add one-half the contour interval to the elevation of the last contour line. In this example, the last contour line before the hilltop is an index contour line numbered 600. Add one-half the contour interval, 10 meters, to the index contour line. The elevation of the hilltop would be 610 meters.

g. There may be times when you need to determine the elevation of points to a greater accuracy. To do this, you must determine how far between the two contour lines the point lies. However, most military needs are satisfied by estimating the elevation of points between contour lines (Figure 10-4).



**Figure 10-4. Points between contour lines.**

(1) If the point is less than one-fourth the distance between contour lines, the elevation will be the same as the last contour line. In Figure 10-4, the elevation of *point a* will be 100 meters. To estimate the elevation of a point between one-fourth and three-fourths of the distance between contour lines, add one-half the

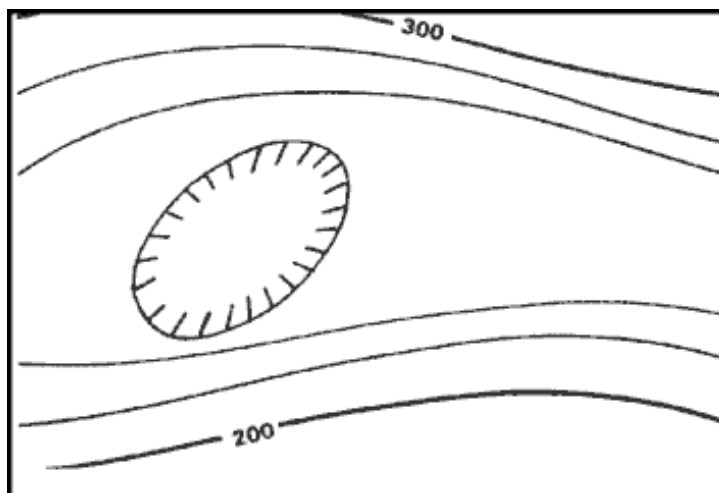


contour interval to the last contour line.

(2) *Point b* is one-half the distance between contour lines. The contour line immediately below *point b* is at an elevation of 160 meters. The contour interval is 20 meters; thus one-half the contour interval is 10 meters. In this case, add 10 meters to the last contour line of 160 meters. The elevation of *point b* would be about 170 meters.

(3) A point located more than three-fourths of the distance between contour lines is considered to be at the same elevation as the next contour line. *Point c* is located three-fourths of the distance between contour lines. In *Figure 10-4*, *point c* would be considered to be at an elevation of 180 meters.

h. To estimate the elevation to the bottom of a depression, subtract one-half the contour interval from the value of the lowest contour line before the depression. In *Figure 10-5*, the lowest contour line before the depression is 240 meters in elevation. Thus, the elevation at the edge of the depression is 240 meters. To determine the elevation at the bottom of the depression, subtract one-half the contour interval. The contour interval for this example is 20 meters. Subtract 10 meters from the lowest contour line immediately before the depression. The result is that the elevation at the bottom of the depression is 230 meters. The tick marks on the contour line forming a depression always point to lower elevations.



**Figure 10-5. Depression.**

i. In addition to the contour lines, bench marks and spot elevations are used to indicate points of known elevations on the map.

(1) Bench marks, the more accurate of the two, are symbolized by a black X, such as X BM 214. The 214 indicates that the center of the X is at an elevation of 214 units of measure (feet, meters, or yards) above mean sea level. To determine the units of measure, refer to the contour interval in the marginal information.

(2) Spot elevations are shown by a brown X and are usually located at road junctions and on hilltops and other prominent

terrain features. If the elevation is shown in black numerals, it has been checked for accuracy; if it is in brown, it has not been checked.

**NOTE:** New maps are being printed using a dot instead of brown Xs.

[Back to Elevation and Relief](#)

Check out the **Amazon Coupons** before you buy.

Copyright © 2001-2002 Jalic LLC. All Rights Reserved.

[Disclaimer](#) | [Privacy Policy](#) | [Contact Us](#)



[Orienteering Home](#)

**The Sport:**

- [Orienteering History](#)
- [Orienteering Overview](#)
- [Course Setup](#)
- [Officials](#)
- [Start/Finish Areas](#)
- [Course Safety](#)
- [Control Point](#)
- [Guidelines](#)
- [Map Symbols](#)
- [Orienteering Techniques](#)
- [Civilian Orienteering](#)

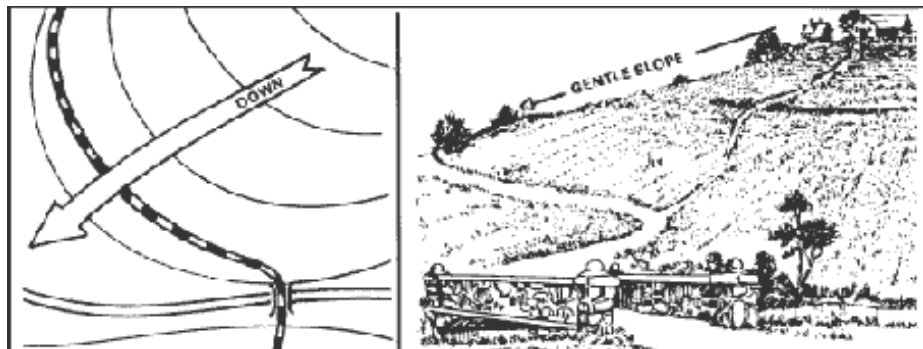
**The Skills:**

- [Maps](#)
- [Marginal Information and Symbols](#)
- [Grids](#)
- [Scale and Distance](#)
- [Direction](#)
- [Overlays](#)
- [Aerial Photographs](#)
- [Navigation](#)
- [Equipment and Methods](#)
- [Elevation and Relief](#)
- [Terrain Association](#)
- [Navigation in Different Types of Terrain](#)
- [Field Sketching](#)
- [Map Folding](#)
- [Techniques](#)
- [Units of Measure and Conversion Factors](#)

## Types of Slopes

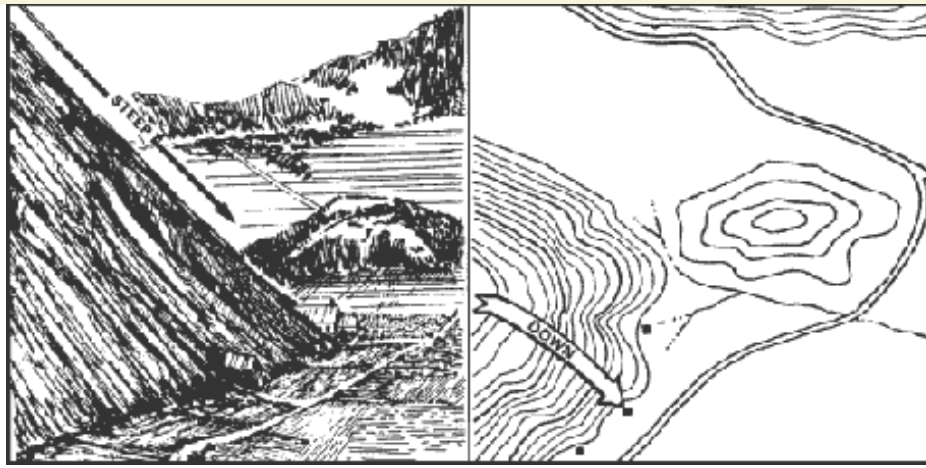
Depending on the military mission, soldiers may need to determine not only the height of a hill, but the degree of the hill's slope as well. The rate of rise or fall of a terrain feature is known as its slope. The speed at which equipment or personnel can move is affected by the slope of the ground or terrain feature. This slope can be determined from the map by studying the contour lines—the closer the contour lines, the steeper the slope; the farther apart the contour lines, the gentler the slope. Four types of slopes that concern the military are as follows:

- a. **Gentle.** Contour lines showing a uniform, gentle slope will be evenly spaced and wide apart (Figure 10-6). Considering relief only, a uniform, gentle slope allows the defender to use grazing fire. The attacking force has to climb a slight incline.



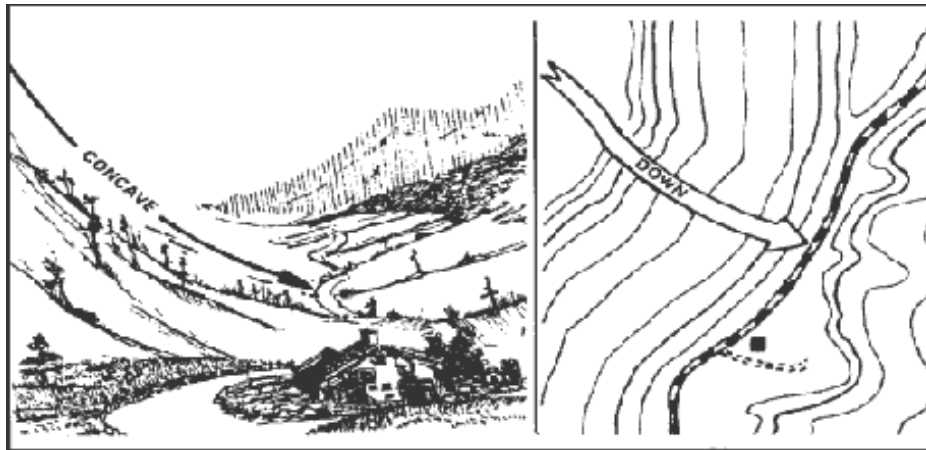
**Figure 10-6. Uniform, gentle slope.**

- b. **Steep.** Contour lines showing a uniform, steep slope on a map will be evenly spaced, but close together. Remember, the closer the contour lines, the steeper the slope (Figure 10-7). Considering relief only, a uniform, steep slope allows the defender to use grazing fire, and the attacking force has to negotiate a steep incline.



**Figure 10-7. Uniform, steep slope.**

c. **Concave.** Contour lines showing a concave slope on a map will be closely spaced at the top of the terrain feature and widely spaced at the bottom (Figure 10-8). Considering relief only, the defender at the top of the slope can observe the entire slope and the terrain at the bottom, but he cannot use grazing fire. The attacker would have no cover from the defender's observation of fire, and his climb would become more difficult as he got farther up the slope.



**Figure 10-8. Concave slope.**

d. **Convex.** Contour lines showing a convex slope on a map will be widely spaced at the top and closely spaced at the bottom (Figure 10-9). Considering relief only, the defender at the top of the convex slope can obtain a small distance of grazing fire, but he cannot observe most of the slope or the terrain at the bottom. The attacker will have concealment on most of the slope and an easier climb as he nears the top.



**Figure 10-9. Convex slope.**

[Back to Elevation and Relief](#)

Check out the [Amazon Coupons](#) before you buy.

Copyright © 2001-2002 Jalic LLC. All Rights Reserved.

[Disclaimer](#) | [Privacy Policy](#) | [Contact Us](#)



**Orienteering Home**

**The Sport:**

- **Orienteering History**
- **Orienteering**

**Overview**

- **Course Setup**
- **Officials**
- **Start/Finish Areas**
- **Course Safety**
- **Control Point**

**Guidelines**

- **Map Symbols**
- **Orienteering**

**Techniques**

- **Civilian Orienteering**

**The Skills:**

- **Maps**
- **Marginal Information and Symbols**
- **Grids**
- **Scale and Distance**
- **Direction**
- **Overlays**
- **Aerial Photographs**
- **Navigation**

**Equipment and**

**Methods**

- **Elevation and Relief**
- **Terrain Association**
- **Navigation in**

**Different Types of Terrain**

- **Field Sketching**
- **Map Folding**

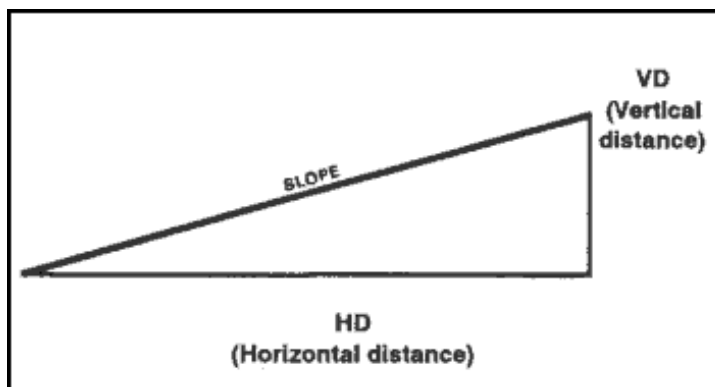
**Techniques**

- **Units of Measure and Conversion Factors**

## Percentage of Slope

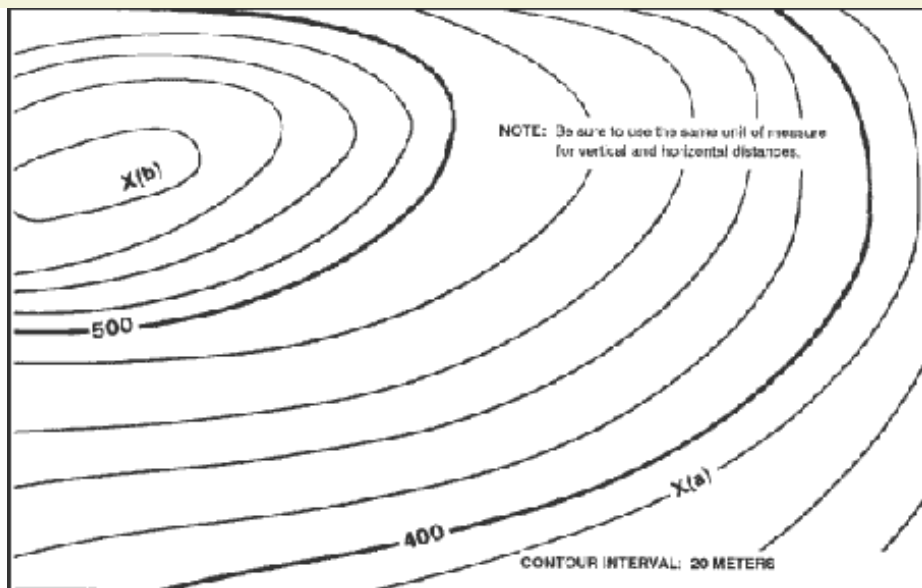
The speed at which personnel and equipment can move up or down a hill is affected by the slope of the ground and the limitations of the equipment. Because of this, a more exact way of describing a slope is necessary.

- a. Slope may be expressed in several ways, but all depend upon the comparison of vertical distance (VD) to horizontal distance (HD) (Figure 10-10). Before we can determine the percentage of a slope, we must know the VD of the slope. The VD is determined by subtracting the lowest point of the slope from the highest point. Use the contour lines to determine the highest and lowest point of the slope (Figure 10-11).



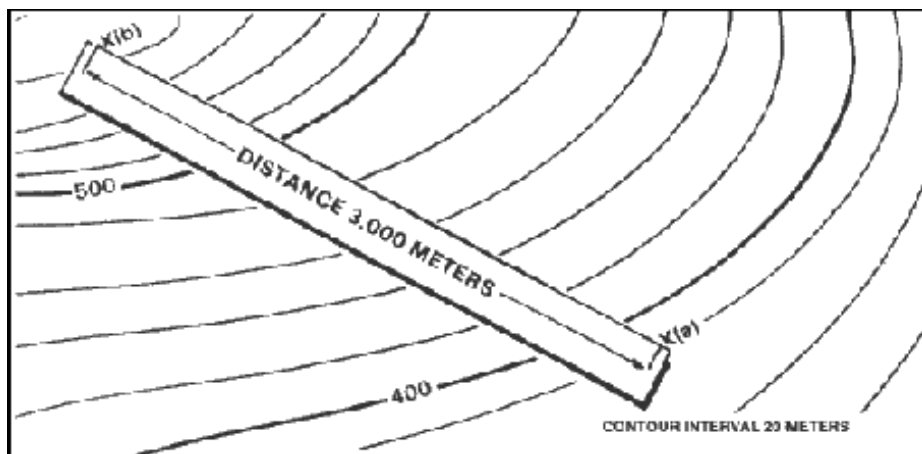
**Figure 10-10. Slope diagram.**





**Figure 10-11. Contour line around a slope.**

b. To determine the percentage of the slope between points (a) and (b) in Figure 10-11, determine the elevation of point (b) (590 meters). Then determine the elevation of point (a) (380 meters). Determine the vertical distance between the two points by subtracting the elevation of point (a) from the elevation of point .The difference (210 meters) is the VD between points (a) and (b). Then measure the HD between the two points on the map in Figure 10-12. After the horizontal distance has been determined, compute the percentage of the slope by using the formula shown in Figure 10-13.



**Figure 10-12. Measuring horizontal distance.**

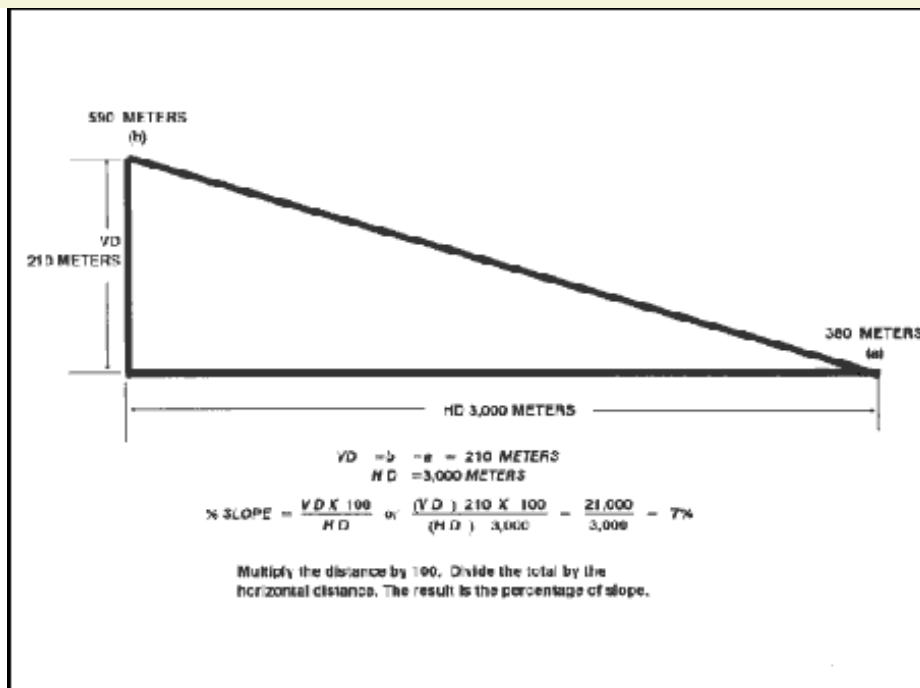


Figure 10-13. Percentage of slope in meters.

c. The slope angle can also be expressed in degrees. To do this, determine the VD and HD of the slope. Multiply the VD by 57.3 and then divide the total by the HD (Figure 10-14). This method determines the approximate degree of slope and is reasonably accurate for slope angles less than 20°.

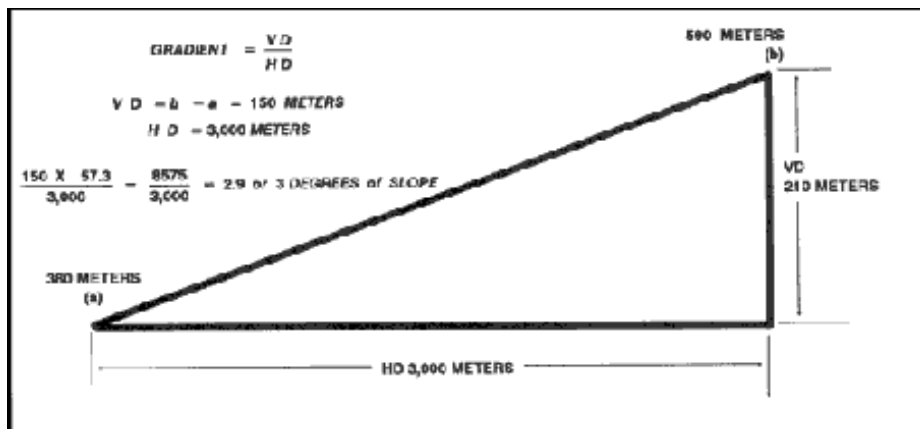


Figure 10-14. Degree of slope.

d. The slope angle can also be expressed as a gradient. The relationship of horizontal and vertical distance is expressed as a fraction with a numerator of one (Figure 10-15).

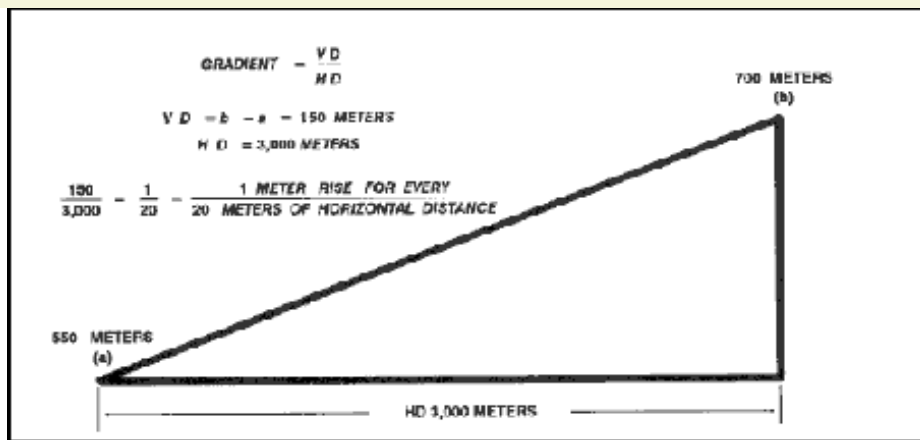


Figure 10-15. Gradient.

Back to Elevation and Relief

Check out the **Amazon Coupons** before you buy.

Copyright © 2001-2002 Jalic LLC. All Rights Reserved.

**Disclaimer | Privacy Policy | Contact Us**



[Orienteering Home](#)

The Sport:

- [Orienteering History](#)
- [Orienteering Overview](#)
- [Course Setup](#)
- [Officials](#)
- [Start/Finish Areas](#)
- [Course Safety](#)
- [Control Point](#)
- [Guidelines](#)
- [Map Symbols](#)
- [Orienteering Techniques](#)
- [Civilian Orienteering](#)

The Skills:

- [Maps](#)
- [Marginal Information and Symbols](#)
- [Grids](#)
- [Scale and Distance](#)
- [Direction](#)
- [Overlays](#)
- [Aerial Photographs](#)
- [Navigation](#)
- [Equipment and Methods](#)
- [Elevation and Relief](#)
- [Terrain Association](#)
- [Navigation in Different Types of Terrain](#)
- [Field Sketching](#)
- [Map Folding](#)
- [Techniques](#)
- [Units of Measure and Conversion Factors](#)

## Terrain Features

All terrain features are derived from a complex landmass known as a mountain or ridgeline (Figure 10-16). The term ridgeline is not interchangeable with the term ridge. A ridgeline is a line of high ground, usually with changes in elevation along its top and low ground on all sides from which a total of 10 natural or man-made terrain features are classified.

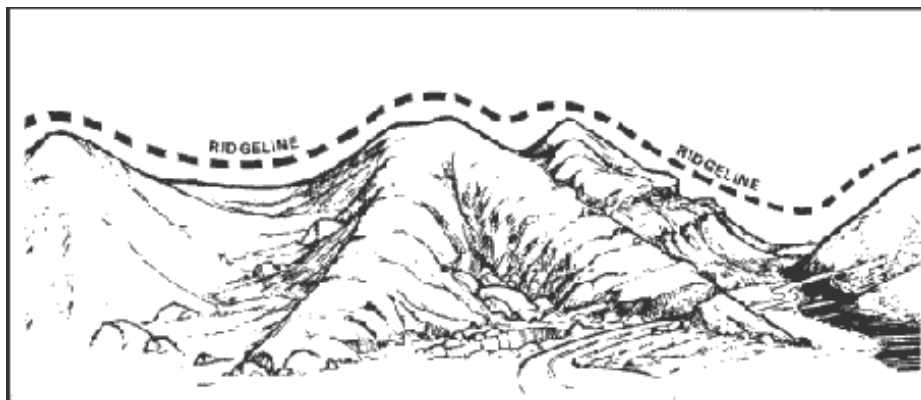
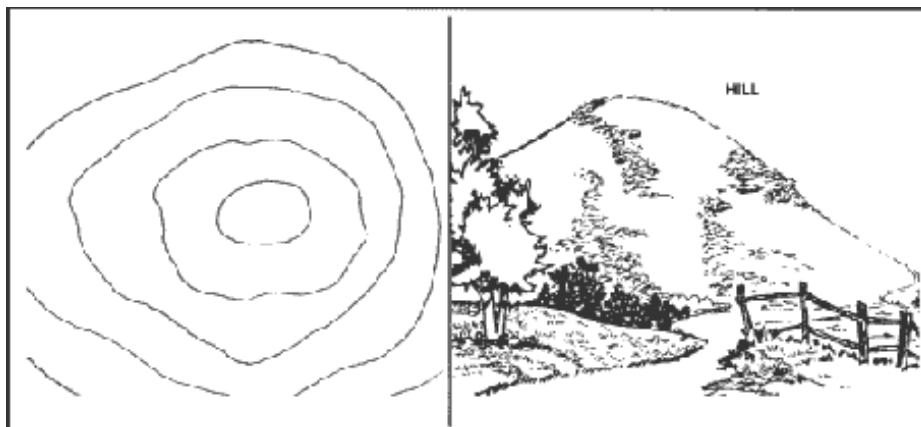


Figure 10-16. Ridgeline.

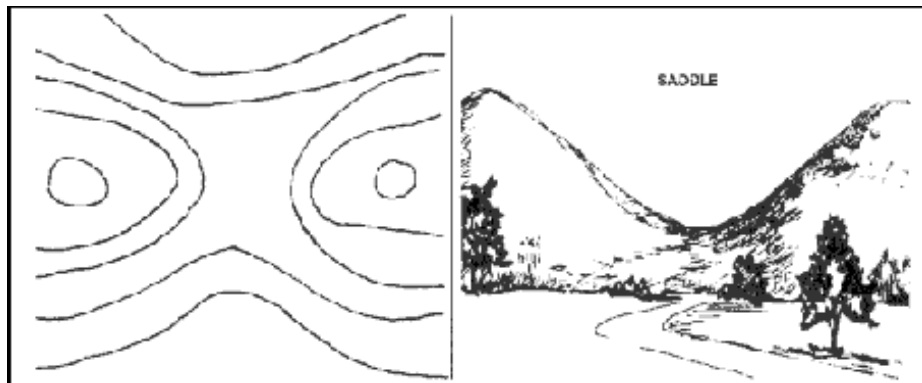
a. Major Terrain Features.

(1) **Hill.** A hill is an area of high ground. From a hilltop, the ground slopes down in all directions. A hill is shown on a map by contour lines forming concentric circles. The inside of the smallest closed circle is the hilltop (Figure 10-17).



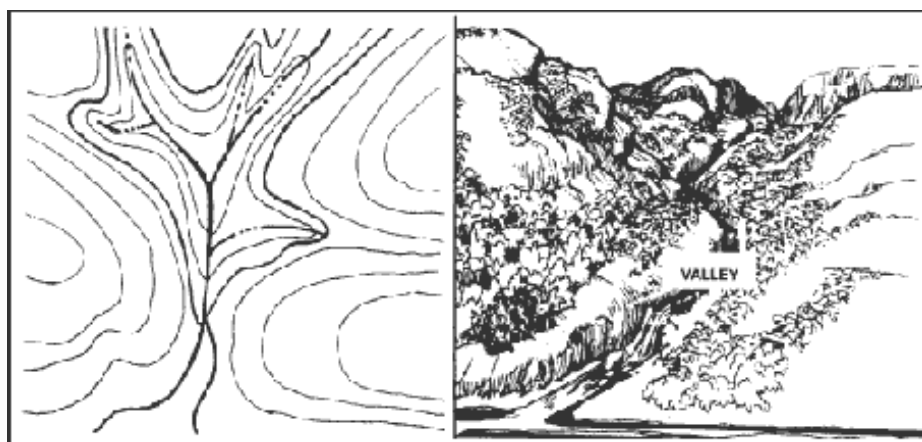
**Figure 10-17. Hill.**

(2) **Saddle.** A saddle is a dip or low point between two areas of higher ground. A saddle is not necessarily the lower ground between two hilltops; it may be simply a dip or break along a level ridge crest. If you are in a saddle, there is high ground in two opposite directions and lower ground in the other two directions. A saddle is normally represented as an hourglass (Figure 10-18).



**Figure 10-18. Saddle.**

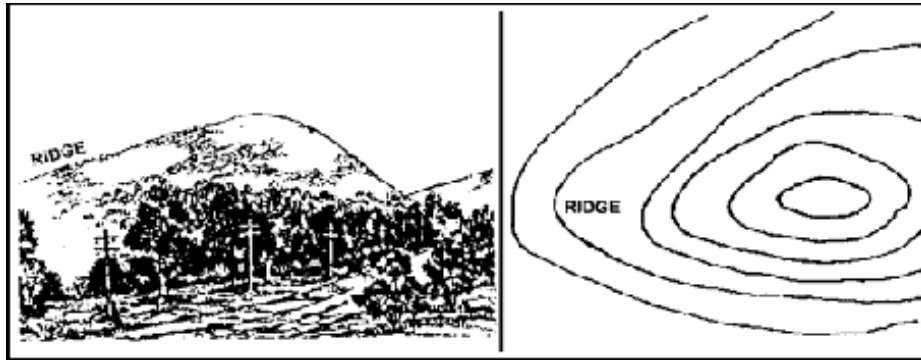
(3) **Valley.** A valley is a stretched-out groove in the land, usually formed by streams or rivers. A valley begins with high ground on three sides, and usually has a course of running water through it. If standing in a valley, three directions offer high ground, while the fourth direction offers low ground. Depending on its size and where a person is standing, it may not be obvious that there is high ground in the third direction, but water flows from higher to lower ground. Contour lines forming a valley are either U-shaped or V-shaped. To determine the direction water is flowing, look at the contour lines. The closed end of the contour line (U or V) always points upstream or toward high ground (Figure 10-19).



**Figure 10-19. Valley.**

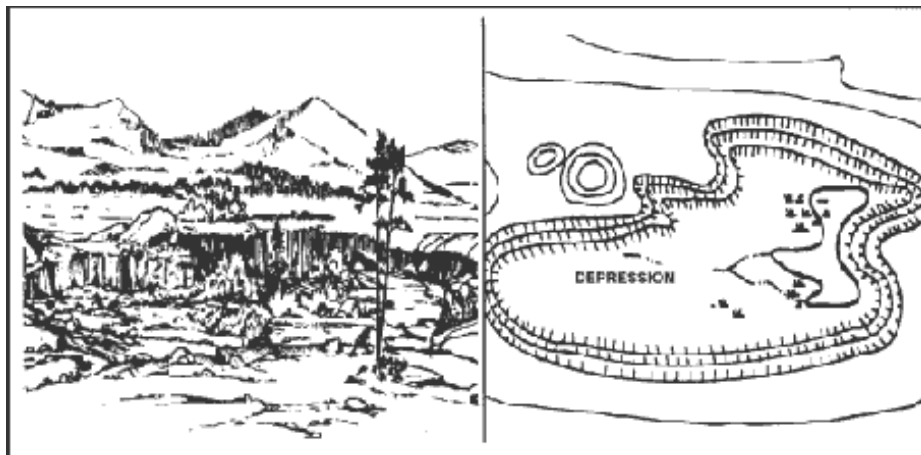
(4) **Ridge.** A ridge is a sloping line of high ground. If you are standing on the centerline of a ridge, you will normally have low ground in three directions and high ground in one direction with varying degrees of slope. If you cross a ridge at right angles, you will climb steeply to the crest and then descend steeply to the base.

When you move along the path of the ridge, depending on the geographic location, there may be either an almost unnoticeable slope or a very obvious incline. Contour lines forming a ridge tend to be U-shaped or V-shaped. The closed end of the contour line points away from high ground (Figure 10-20).



**Figure 10-20. Ridge.**

(5) **Depression.** A depression is a low point in the ground or a sinkhole. It could be described as an area of low ground surrounded by higher ground in all directions, or simply a hole in the ground. Usually only depressions that are equal to or greater than the contour interval will be shown. On maps, depressions are represented by closed contour lines that have tick marks pointing toward low ground (Figure 10-21).

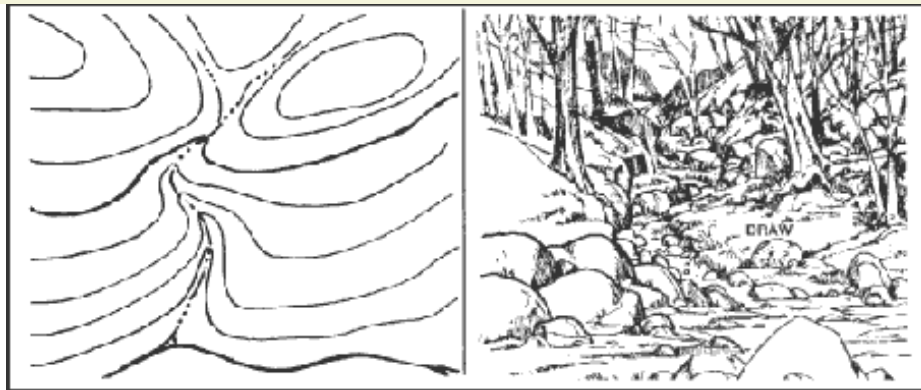


**Figure 10-21. Depression.**

**b. Minor Terrain Features.**

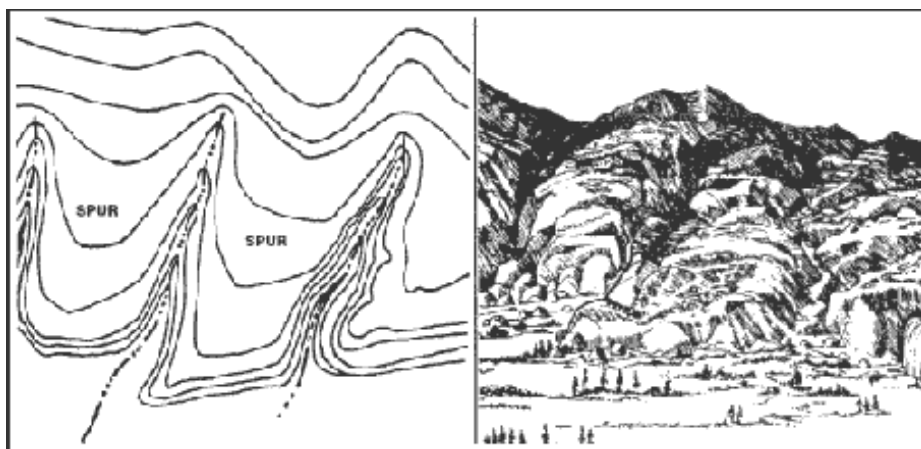
(1) **Draw.** A draw is a less developed stream course than a valley. In a draw, there is essentially no level ground and, therefore, little or no maneuver room within its confines. If you are standing in a draw, the ground slopes upward in three directions and downward in the other direction. A draw could be considered as the initial formation of a valley. The contour lines depicting a draw are U-shaped or V-shaped, pointing toward high ground (Figure 10-22).





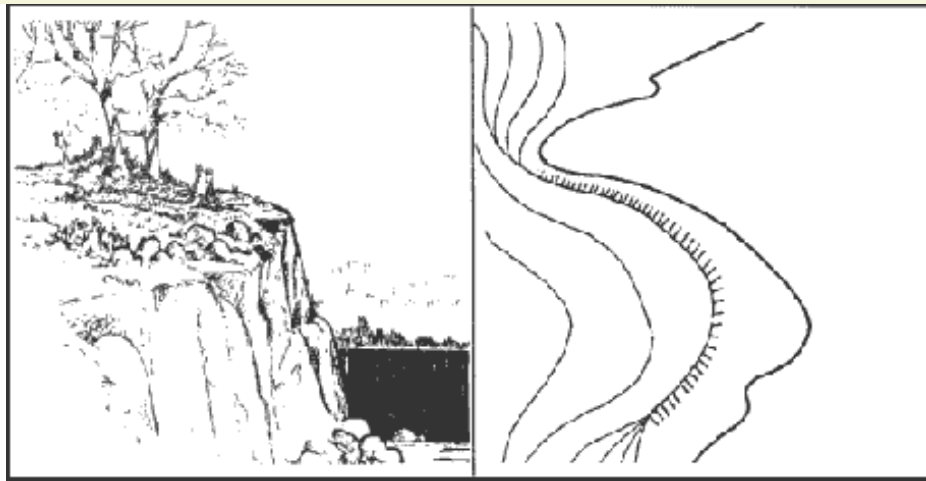
**Figure 10-22. Draw.**

(2) *Spur*. A spur is a short, continuous sloping line of higher ground, normally jutting out from the side of a ridge. A spur is often formed by two rough parallel streams, which cut draws down the side of a ridge. The ground sloped down in three directions and up in one direction. Contour lines on a map depict a spur with the U or V pointing away from high ground (Figure 10-23).

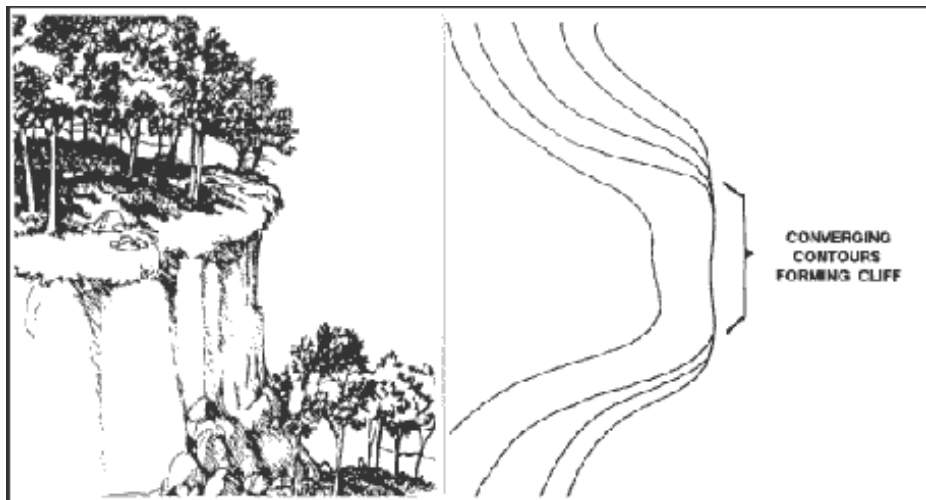


**Figure 10-23. Spur.**

(3) *Cliff*. A cliff is a vertical or near vertical feature; it is an abrupt change of the land. When a slope is so steep that the contour lines converge into one "carrying" contour of contours, this last contour line has tick marks pointing toward low ground (Figure 10-24A). Cliffs are also shown by contour lines very close together and, in some instances, touching each other (Figure 10-24B).



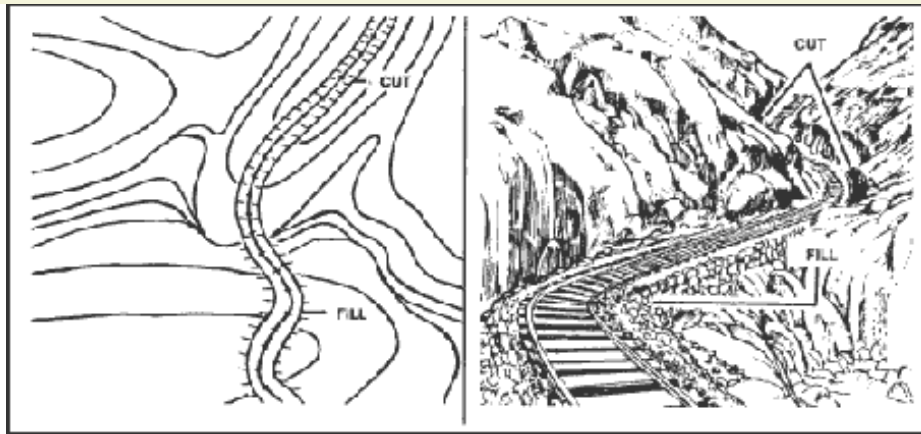
**Figure 10-24A. Cliff.**



**Figure 10-24B. Cliff.**

**c. Supplementary Terrain Features.**

(1) *Cut*. A cut is a man-made feature resulting from cutting through raised ground, usually to form a level bed for a road or railroad track. Cuts are shown on a map when they are at least 10 feet high, and they are drawn with a contour line along the cut line. This contour line extends the length of the cut and has tick marks that extend from the cut line to the roadbed, if the map scale permits this level of detail (Figure 10-25).



**Figure 10-25. Cut and fill.**

(2) **Fill.** A fill is a man-made feature resulting from filling a low area, usually to form a level bed for a road or railroad track. Fills are shown on a map when they are at least 10 feet high, and they are drawn with a contour line along the fill line. This contour line extends the length of the filled area and has tick marks that point toward lower ground. If the map scale permits, the length of the fill tick marks are drawn to scale and extend from the base line of the fill symbol (Figure 10-25).

## Back to Elevation and Relief

Check out the **Amazon Coupons** before you buy.

Copyright © 2001-2002 Jalic LLC. All Rights Reserved.

**Disclaimer | Privacy Policy | Contact Us**



# Orienteering



[Orienteering Home](#)

## Interpretation of Terrain Features

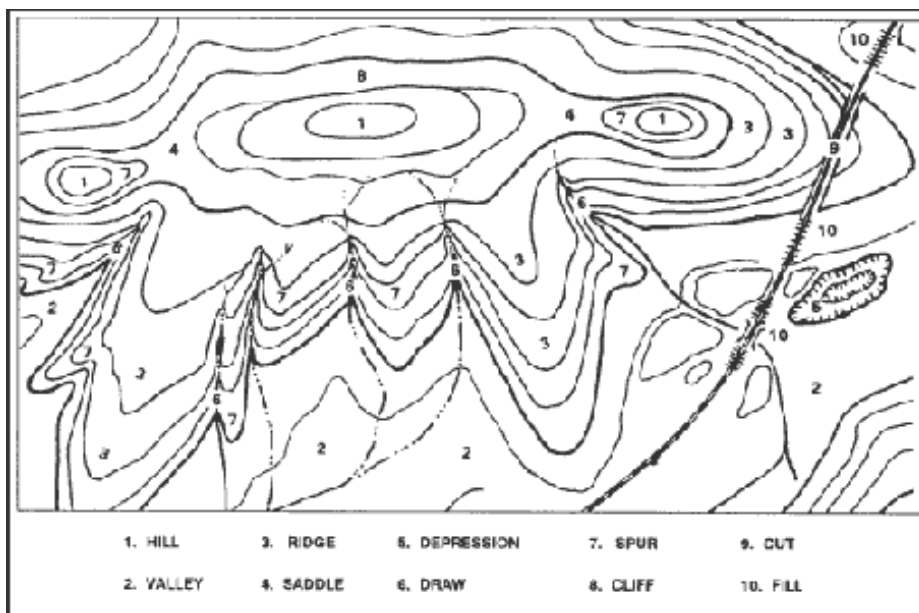
### The Sport:

- [Orienteering History](#)
- [Orienteering Overview](#)
- [Course Setup](#)
- [Officials](#)
- [Start/Finish Areas](#)
- [Course Safety](#)
- [Control Point Guidelines](#)
- [Map Symbols](#)
- [Orienteering Techniques](#)
- [Civilian Orienteering](#)

### The Skills:

- [Maps](#)
- [Marginal Information and Symbols](#)
- [Grids](#)
- [Scale and Distance](#)
- [Direction](#)
- [Overlays](#)
- [Aerial Photographs](#)
- [Navigation](#)
- [Equipment and Methods](#)
- [Elevation and Relief](#)
- [Terrain Association](#)
- [Navigation in Different Types of Terrain](#)
- [Field Sketching](#)
- [Map Folding](#)
- [Techniques](#)
- [Units of Measure and Conversion Factors](#)

Terrain features do not normally stand alone. To better understand these when they are depicted on a map, you need to interpret them. Terrain features (Figure 10-26) are interpreted by using contour lines, the SOSES approach, ridgeling, or streamlining.

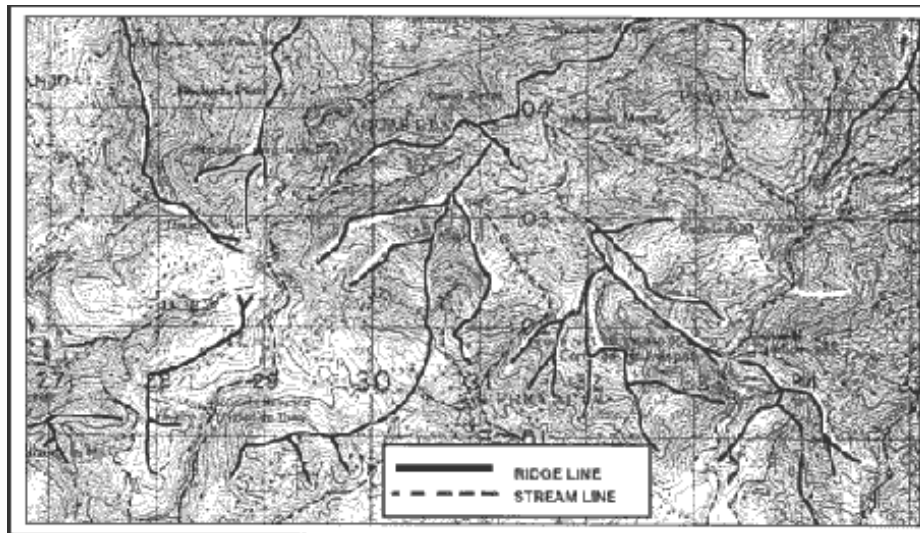


**Figure 10-26. Terrain features.**

a. **Contour Lines.** Emphasizing the main contour lines is a technique used to interpret the terrain of an area. By studying these contour lines, you are able to obtain a better understanding of the layout of the terrain and to decide on the best route.

(1) The following description pertains to Figure 10-27. Running east to west across the complex landmass is a ridgeline. A ridgeline is a line of high ground, usually with changes in elevation along its top and low ground on all sides. The changes in elevation are the three hilltops and two saddles along the ridgeline. From the top of each hill, there is lower ground in all directions. The saddles have lower ground in two directions and high ground in the opposite two directions. The contour lines of each saddle form half an hourglass shape. Because of the difference in size of the higher ground on the two opposite sides of a saddle, a full

hourglass shape of a saddle may not be apparent.



**Figure 10-27. Ridgeling and streamlining.**

(2) There are four prominent ridges. A ridge is on each end of the ridgeline and two ridges extend south from the ridgeline. All of the ridges have lower ground in three directions and higher ground in one direction. The closed ends of the U's formed by the contour lines point away from higher ground.

(3) To the south lies a valley; the valley slopes downward from east to west. Note that the U of the contour line points to the east, indicating higher ground in that direction and lower ground to the west. Another look at the valley shows high ground to the north and south of the valley.

(4) Just east of the valley is a depression. There is higher ground in all directions when looking from the bottom of the depression.

(5) There are several spurs extending generally south from the ridgeline. They, like ridges, have lower ground in three directions and higher ground in one direction. Their contour line U's point away from higher ground.

(6) Between the ridges and spurs are draws. They, like valleys, have higher ground in three directions and lower ground in one direction. Their contour line U's and V's point toward higher ground.

(7) Two contour lines on the north side of the center hill are touching or almost touching. They have ticks indicating a vertical or nearly vertical slope or a cliff.

(8) The road cutting through the eastern ridge depicts cuts and fills. The breaks in the contour lines indicate cuts, and the ticks pointing away from the roadbed on each side of the road indicate fills.

b. **SOSES.** A recommended technique for identifying specific terrain



features and then locating them on the map is to make use of five of their characteristics known by the mnemonic SOSES. Terrain features can be examined, described, and compared with each other and with corresponding map contour patterns in terms of their shapes, orientations, sizes, elevations, and slopes.

- (1) **Shape.** The general form or outline of the feature at its base.
- (2) **Orientation.** The general trend or direction of a feature from your viewpoint. A feature can be in line, across, or at an angle to your viewpoint.
- (3) **Size.** The length or width of a feature horizontally across its base. For example, one terrain feature might be larger or smaller than another terrain feature.
- (4) **Elevation.** The height of a terrain feature. This can be described either in absolute or relative terms as compared to the other features in the area. One landform may be higher, lower, deeper, or shallower than another.
- (5) **Slope.** The type (uniform, convex, or concave) and the steepness or angle (steep or gentle) of the sides of a terrain feature.

Through practice, you can learn to identify several individual terrain features in the field and see how they vary in appearance.

**NOTE:** Further terrain analysis using SOSES can be learned by using the Map Interpretation and Terrain Association Course. It consists of three separate courses of instruction: basic, intermediate, and advanced. Using photographic slides of terrain and other features, basic instruction teaches how to identify basic terrain feature types on the ground and on the map. Intermediate instruction teaches elementary map interpretation and terrain association using real world scenes and map sections of the same terrain. Advanced instruction teaches advanced techniques for map interpretation and terrain association. The primary emphasis is on the concepts of map design guidelines and terrain association skills. Map design guidelines refer to the rules and practices used by cartographers in the compilation and symbolization of military topographic maps. Knowledge of the selection, classification, and symbolization of mapped features greatly enhances the user's ability to interpret map information.

c. **Ridgelineing.** This technique helps you to visualize the overall lay of the ground within the area of interest on the map. Follow these steps:

- (1) Identify on the map the crests of the ridgelines in your area of operation by identifying the close-out contours that lie along the hilltop.



(2) Trace over the crests so each ridgeline stands out clearly as one identifiable line.

(3) Go back over each of the major ridgelines and trace over the prominent ridges and spurs that come out of the ridgelines.

The usual colors used for this tracing are red or brown; however, you may use any color at hand. When you have completed the ridgeline process, you will find that the high ground on the map will stand out and that you will be able to see the relationship between the various ridgelines (Figure 10-27).

d. **Streamlining.** This procedure (Figure 10-27) is similar to that of ridgelineing.

(1) Identify all the mapped streams in the area of operations.

(2) Trace over them to make them stand out more prominently.

(3) Then identify other low ground, such as smaller valleys or draws that feed into the major streams, and trace over them.

This brings out the drainage pattern and low ground in the area of operation on the map. The color used for this is usually blue; but again, if blue is not available, use any color at hand so long as the distinction between the ridgelines and the streamlines is clear.

## Back to Elevation and Relief

Check out the **Amazon Coupons** before you buy.

Copyright © 2001-2002 Jalic LLC. All Rights Reserved.

**Disclaimer | Privacy Policy | Contact Us**



# Orienteering



[Orienteering Home](#)

**The Sport:**

- [Orienteering History](#)
- [Orienteering Overview](#)
- [Course Setup](#)
- [Officials](#)
- [Start/Finish Areas](#)
- [Course Safety](#)
- [Control Point](#)
- [Guidelines](#)
- [Map Symbols](#)
- [Orienteering Techniques](#)
- [Civilian Orienteering](#)

**The Skills:**

- [Maps](#)
- [Marginal Information and Symbols](#)
- [Grids](#)
- [Scale and Distance](#)
- [Direction](#)
- [Overlays](#)
- [Aerial Photographs](#)
- [Navigation](#)
- [Equipment and Methods](#)
- [Elevation and Relief](#)
- [Terrain Association](#)
- [Navigation in Different Types of Terrain](#)
- [Field Sketching](#)
- [Map Folding](#)
- [Techniques](#)
- [Units of Measure and Conversion Factors](#)

## Profiles

The study of contour lines to determine high and low points of elevation is usually adequate for military operations. However, there may be a few times when we need a quick and precise reference to determine exact elevations of specific points. When exactness is demanded, a profile is required. A profile, within the scope and purpose of this manual, is an exaggerated side view of a portion of the earth's surface along a line between two or more points.

- a. A profile can be used for many purposes. The primary purpose is to determine if line of sight is available. Line of sight is used—
  - (1) To determine defilade positions.
  - (2) To plot hidden areas or dead space.
  - (3) To determine potential direct fire weapon positions.
  - (4) To determine potential locations for defensive positions.
  - (5) To conduct preliminary planning in locating roads, pipelines, railroads, or other construction projects.
  
- b. A profile can be constructed from any contoured map. Its construction requires the following steps:
  - (1) Draw a line on the map from where the profile is to begin to where it is to end (Figure 10-28).

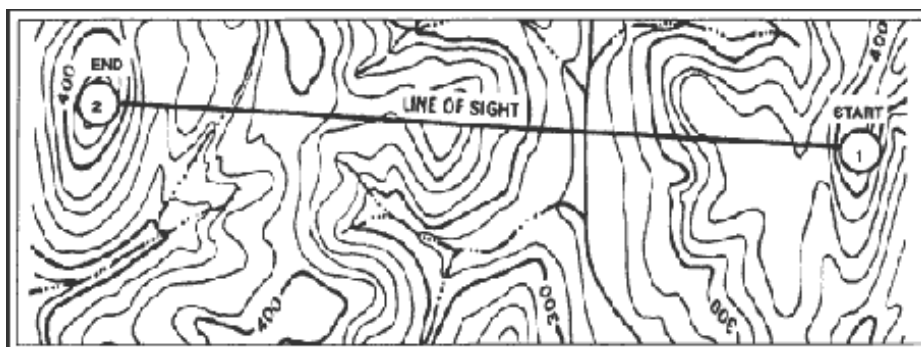


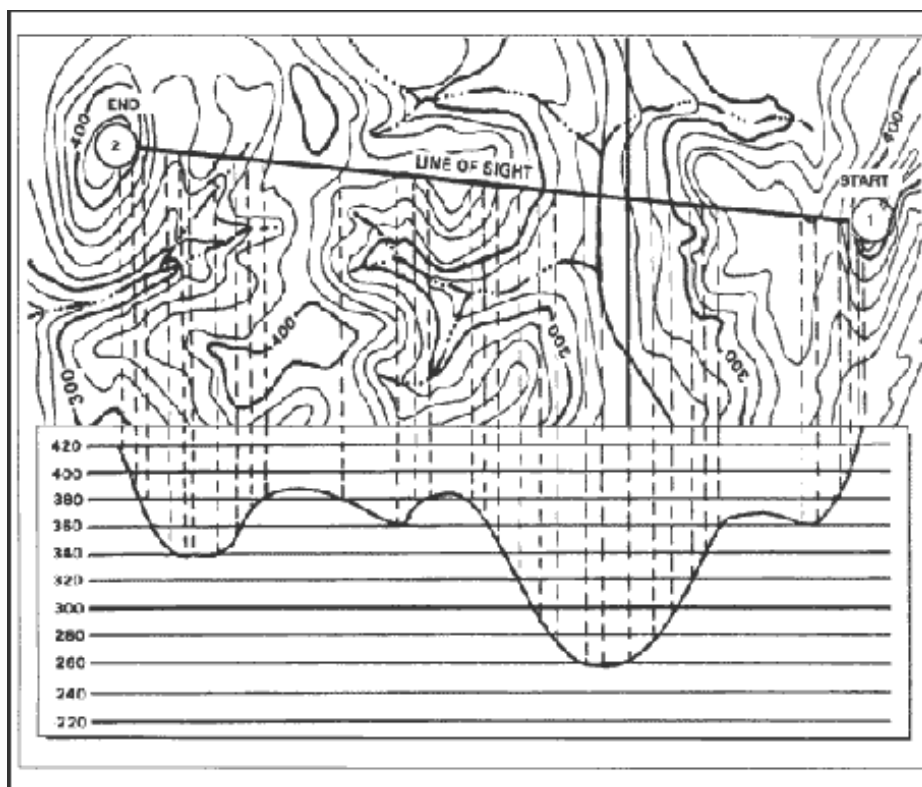
Figure 10-28. Connecting points.

(2) Find the value of the highest and lowest contour lines that cross or touch the profile line. Add one contour value above the highest and one below the lowest to take care of hills and valleys.

(3) Select a piece of lined notebook paper with as many lines as was determined in (2) above. The standard Army green pocket notebook or any other paper with 1/4-inch lines is ideal. Wider lines, up to 5/8-inch, may be used. If lined paper is not available, draw equally spaced horizontal lines on a blank sheet of paper.

(4) Number the top line with the highest value and the bottom line with the lowest value as determined in (2) above.

(5) Number the rest of the lines in sequence, starting with the second line from the top. The lines will be numbered in accordance with the contour interval (Figure 10-29).



**Figure 10-29. Dropping perpendiculars.**

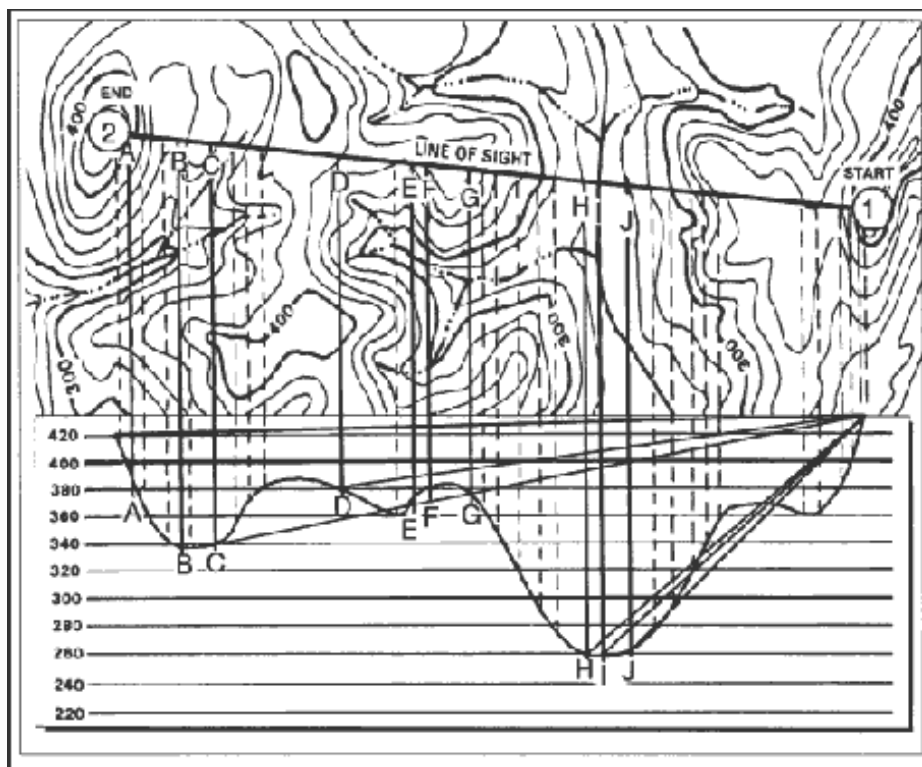
(6) Place the paper on the map with the lines next to and parallel to the profile line (Figure 10-29).

(7) From every point on the profile line where a contour line, stream, intermittent stream, or other body of water crosses or touches, drop a perpendicular line to the line having the same value. Place a tick mark where the perpendicular line crosses the number line (Figure 10-29). Where trees are present, add the height of the trees to the contour line and place a tick mark there. Assume the height of the trees to be 50 feet or 15 meters where dark green tint is shown on the map. Vegetation height may be adjusted up or down when operations in the area have provided known tree heights.

(8) After all perpendicular lines have been drawn and tick marks placed where the lines cross, connect all tick marks with a smooth, natural curve to form a horizontal view or profile of the terrain along the profile line (Figure 10-29).

**NOTE:** The profile drawn may be exaggerated. The spacing between the lines drawn on the sheet of paper determines the amount of exaggeration and may be varied to suit any purpose.

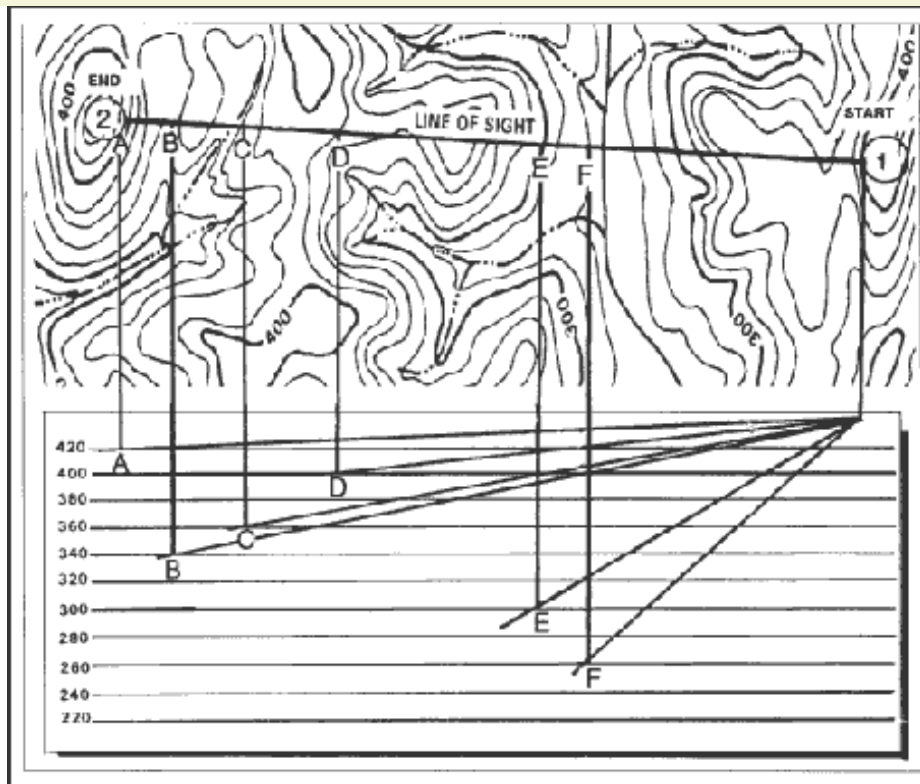
(9) Draw a straight line from the start point to the end point on the profile. If the straight line intersects the curved profile, line of sight to the end point is not available (Figure 10-30).



**Figure 10-30. Drawing lines to additional points.**

(10) Determine the line of sight to other points along the profile line by drawing a line from the start point to additional points. In Figure 10-31, line of sight is available to—

- |              |              |              |
|--------------|--------------|--------------|
| <b>A—Yes</b> | <b>D—Yes</b> | <b>G—Yes</b> |
| <b>B—No</b>  | <b>E—No</b>  | <b>H—No</b>  |
| <b>C—No</b>  | <b>F—No</b>  | <b>I—No</b>  |



**Figure 10-31. Drawing a hasty profile.**

The vertical distance between navigable ground up to the line of sight line is the depth of defilade.

- c. When time is short, or when a complete profile is not needed, one may be constructed showing only the hilltops, ridges, and if desired, the valleys. This is called a hasty profile. It is constructed in the same manner as a full profile (Figure 10-31).

## Back to Elevation and Relief

Check out the **Amazon Coupons** before you buy.

Copyright © 2001-2002 Jalic LLC. All Rights Reserved.

**Disclaimer | Privacy Policy | Contact Us**





# Orienteering

## Orienteering Home

### The Sport:

- Orienteering History
- Orienteering

### Overview

- Course Setup
- Officials
- Start/Finish Areas
- Course Safety
- Control Point

### Guidelines

- Map Symbols
- Orienteering

### Techniques

- Civilian Orienteering

### The Skills:

- Maps
- Marginal Information and Symbols
- Grids
- Scale and Distance
- Direction
- Overlays
- Aerial Photographs
- Navigation

### Equipment and

### Methods

- Elevation and Relief
- Terrain Association
- Navigation in

### Different Types of Terrain

- Field Sketching
- Map Folding

### Techniques

- Units of Measure and Conversion Factors

## Orienting the Map

The first step for a navigator in the field is orienting the map. A map is oriented when it is in a horizontal position with its north and south corresponding to the north and south on the ground. Some orienting techniques follow:

- Using a Compass.** When orienting a map with a compass, remember that the compass measures magnetic azimuths. Since the magnetic arrow points to magnetic north, pay special attention to the declination diagram. There are two techniques used.

- (1) **First Technique.** Determine the direction of the declination and its value from the declination diagram.

- (a) With the map in a horizontal position, take the straightedge on the left side of the compass and place it alongside the north-south grid line with the cover of the compass pointing toward the top of the map. This procedure places the fixed black index line of the compass parallel to north-south grid lines of the map.

- (b) Keeping the compass aligned as directed above, rotate the map and compass together until the magnetic arrow is below the fixed black index line on the compass. At this time, the map is close to being oriented.

- (c) Rotate the map and compass in the direction of the declination diagram.

- (d) If the magnetic north arrow on the map is to the left of the grid north, check the compass reading to see if it equals the G-M angle given in the declination diagram. The map is then oriented (Figure 11-1).



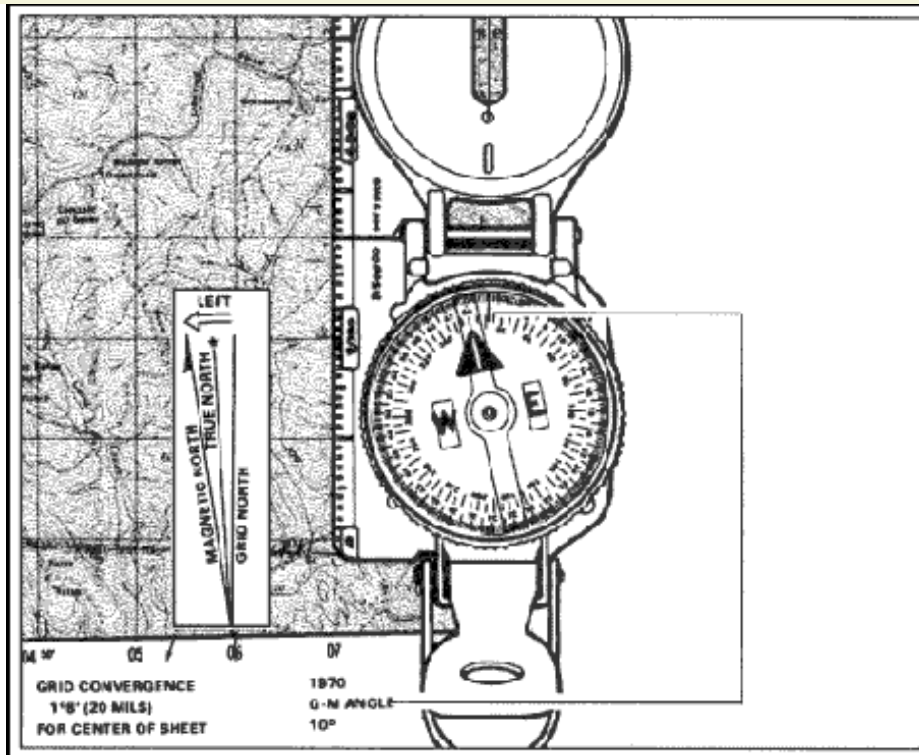
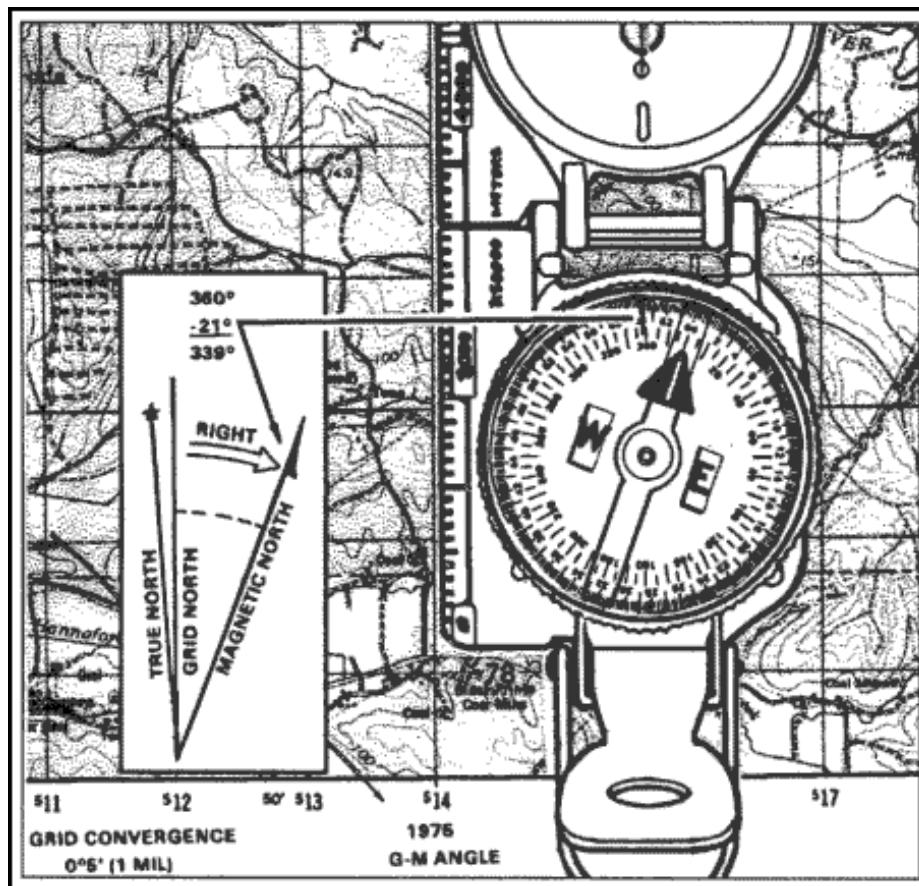


Figure 11-1. Map oriented with 11 degrees west declination.

(e) If the magnetic north is to the right of grid north, check the compass reading to see if it equals 360 degrees minus the G-M angle (Figure 11-2).

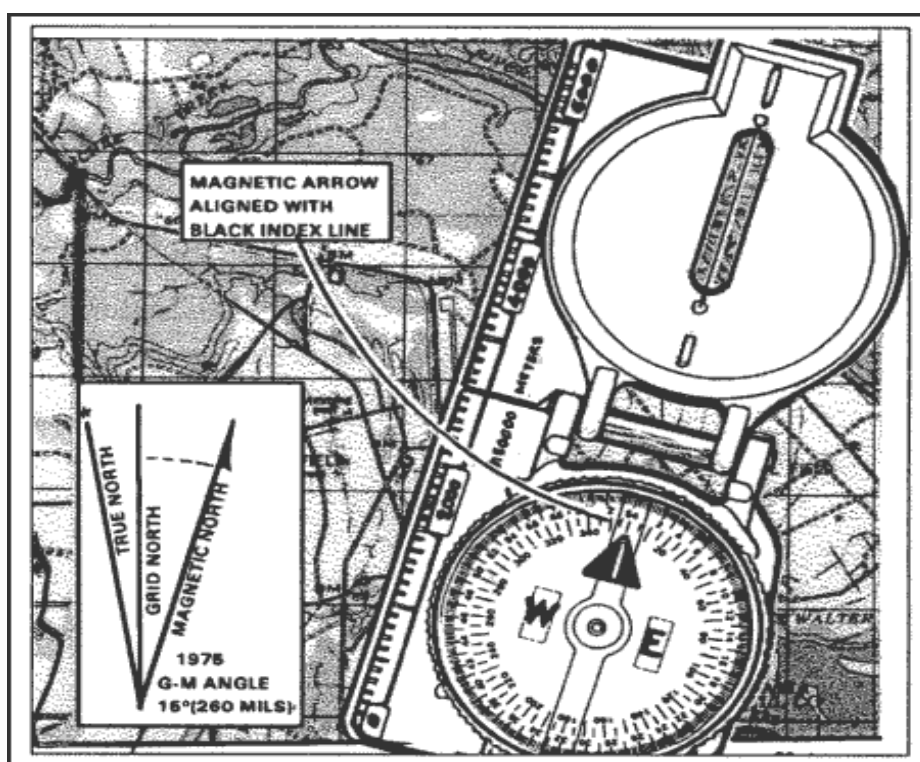


**Figure 11-2. Map oriented with 21 degrees east declination.**

(2) *Second Technique.* Determine the direction of the declination and its value from the declination diagram.

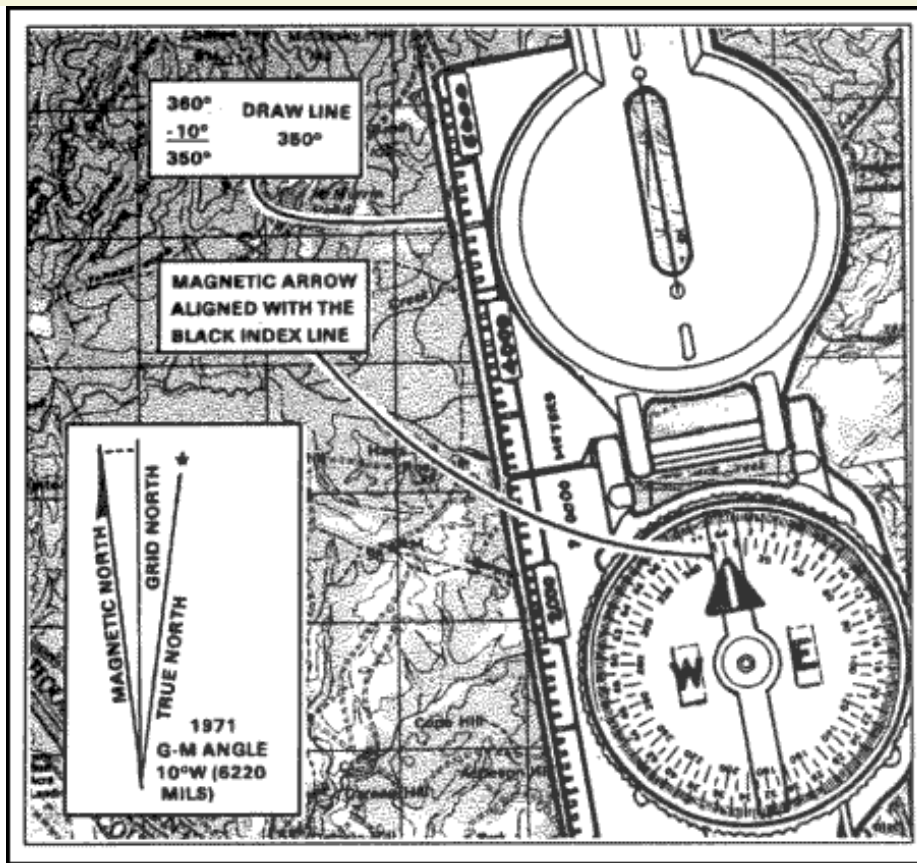
(a) Using any north-south grid line on the map as a base, draw a magnetic azimuth equal to the G-M angle given in the declination diagram with the protractor.

(b) If the declination is easterly (right), the drawn line is equal to the value of the G-M angle. Then align the straightedge, which is on the left side of the compass, alongside the drawn line on the map. Rotate the map and compass until the magnetic arrow of the compass is below the fixed black index line. The map is now oriented (Figure 11-3).



**Figure 11-3. Map oriented with 15 degrees east declination.**

(c) If the declination is westerly (left), the drawn line will equal 360 degrees minus the value of the G-M angle. Then align the straightedge, which is on the left side of the compass, alongside the drawn line on the map. Rotate the map and compass until the magnetic arrow of the compass is below the fixed black index line. The map is now oriented (Figure 11-4).



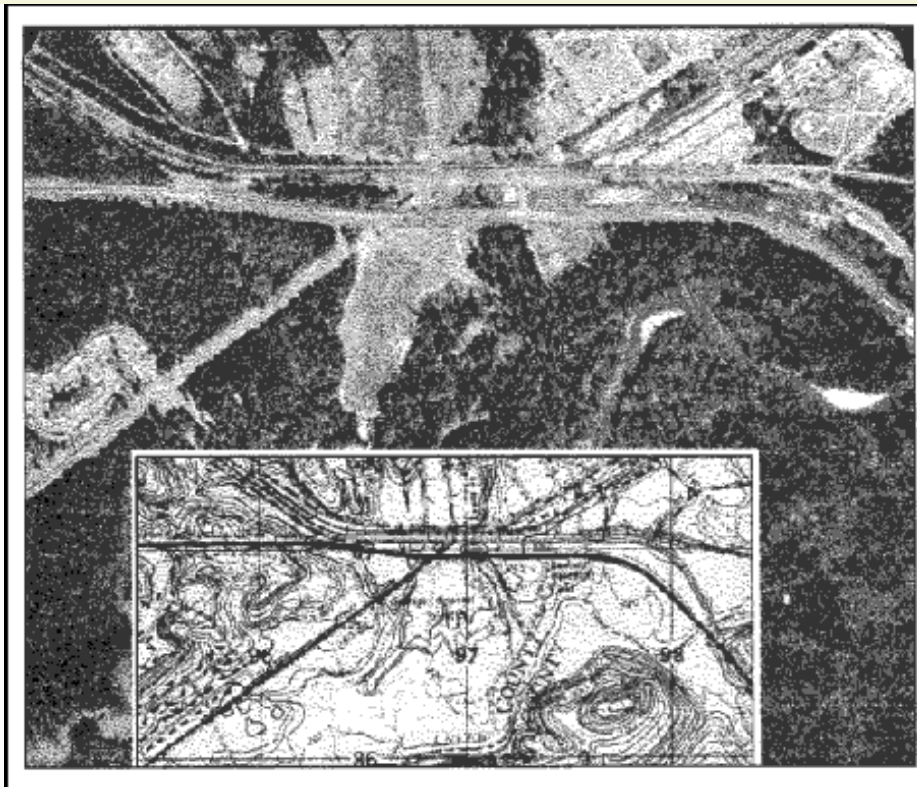
**Figure 11-4. Map oriented with 10 degrees west declination.**

**NOTE:** 1. Once the map is oriented, magnetic azimuths are determined using the compass. Do not move the map from its oriented position since any change in its position moves it out of line with the magnetic north.

2. Special care should be taken whenever orienting your map with a compass. A small mistake can cause you to navigate in the wrong direction.

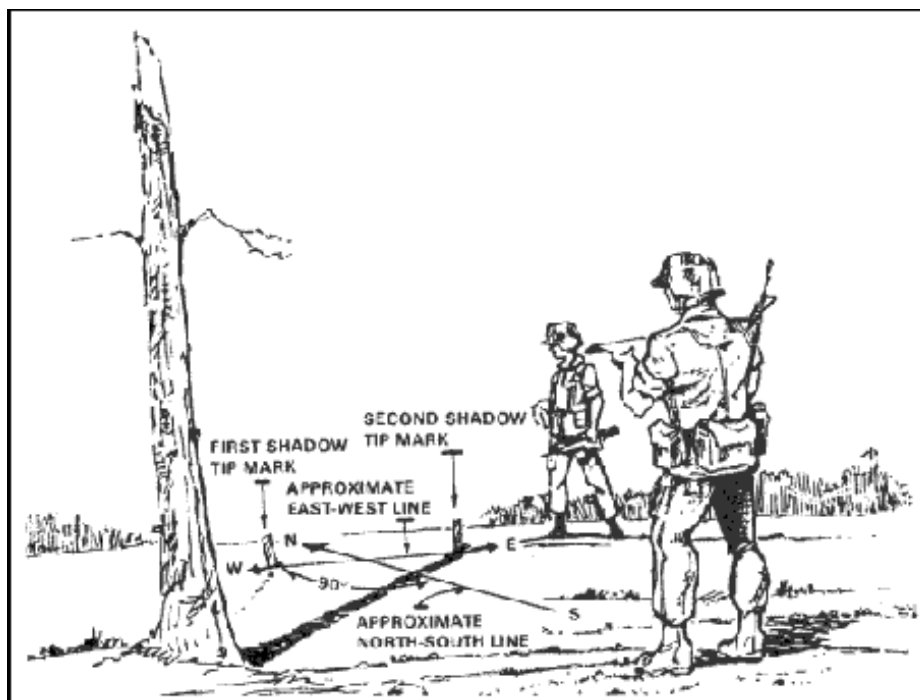
b. **Using Terrain Association.** A map can be oriented by terrain association when a compass is not available or when the user has to make many quick references as he moves across country. Using this method requires careful examination of the map and the ground, and the user must know his approximate location (Figure 11-5). Orienting by this method is discussed in detail in latter parts of this section.





**Figure 11-5. Terrain association.**

c. **Using Field-Expedient Methods.** When a compass is not available and there are no recognizable terrain features, a map may be oriented by any of the field-expedient methods described here. Also see Figure 11-6.



**Figure 11-6. Field-expedient method.**

[Back to Terrain Association](#)

Check out the **Amazon Coupons** before you buy.

Copyright © 2001-2002 Jalic LLC. All Rights Reserved.

**[Disclaimer](#) | [Privacy Policy](#) | [Contact Us](#)**



[Orienteering Home](#)

**The Sport:**

- [Orienteering History](#)
- [Orienteering](#)

**Overview**

- [Course Setup](#)
- [Officials](#)
- [Start/Finish Areas](#)
- [Course Safety](#)
- [Control Point](#)

**Guidelines**

- [Map Symbols](#)
- [Orienteering](#)

**Techniques**

- [Civilian Orienteering](#)

**The Skills:**

- [Maps](#)
- [Marginal Information and Symbols](#)
- [Grids](#)
- [Scale and Distance](#)
- [Direction](#)
- [Overlays](#)
- [Aerial Photographs](#)
- [Navigation](#)

**Equipment and Methods**

- [Elevation and Relief](#)
- [Terrain Association](#)
- [Navigation in](#)

**Different Types of Terrain**

- [Field Sketching](#)
- [Map Folding](#)

**Techniques**

- [Units of Measure and Conversion Factors](#)

## Locations

The key to success in land navigation is to know your location at all times. With this basic knowledge, you can decide what direction and what distance to travel.

- a. **Known Position.** Most important of all is the initial location of the user before starting any movement in the field. If movement takes place without establishing the initial location, everything that is done in the field from there on is a gamble. Determine the initial location by referring to the last known position, by grid coordinates and terrain association, or by locating and orienting your position on the map and ground.
- b. **Known Point/Known Distance (Polar Plot).** This location can be determined by knowing the starting point, the azimuth to the desired objective, and the distance to it.
- c. **Resection.** See "[Direction](#)".
- d. **Modified Resection.** See "[Direction](#)".
- e. **Intersection.** See "[Direction](#)".
- f. **Indirect Fire.** Finding a location by indirect fire is done with smoke. Use the point of impact of the round as a reference point from which distances and azimuth can be obtained.

[Back to Terrain Association](#)

Check out the [Amazon Coupons](#) before you buy.

Copyright © 2001-2002 Jalic LLC. All Rights Reserved.

[Disclaimer](#) | [Privacy Policy](#) | [Contact Us](#)







# Orienteeing

## Orienteeing Home

### The Sport:

- **Orienteeing History**
- **Orienteeing**

### Overview

- **Course Setup**
- **Officials**
- **Start/Finish Areas**
- **Course Safety**
- **Control Point**

### Guidelines

- **Map Symbols**
- **Orienteeing**

### Techniques

- **Civilian Orienteeing**

### The Skills:

- **Maps**
- **Marginal Information and Symbols**
- **Grids**
- **Scale and Distance**
- **Direction**
- **Overlays**
- **Aerial Photographs**
- **Navigation**

### Equipment and

### Methods

- **Elevation and Relief**
- **Terrain Association**
- **Navigation in**

### Different Types of Terrain

- **Field Sketching**
- **Map Folding**

### Techniques

- **Units of Measure and Conversion Factors**

## Terrain Association Usage

The technique of moving by terrain association is more forgiving of mistakes and far less time-consuming than dead reckoning. It best suits those situations that call for movement from one area to another. Errors made using terrain association are easily corrected because you are comparing what you expected to see from the map to what you do see on the ground. Errors are anticipated and will not go unchecked. You can easily make adjustments based upon what you encounter. Periodic position-fixing through either plotted or estimated resection will also make it possible to correct your movements, call for fire, or call in the locations of enemy targets or any other information of tactical or logistical importance.

### a. **Matching the Terrain to the Map by Examining Terrain Features.**

By observing the contour lines in detail, the five major terrain features (hilltop, valley, ridge, depression, and saddle) should be determined. This is a simple task in an area where the observer has ample view of the terrain in all directions. One-by-one, match the terrain features depicted on the map with the same features on the ground. In restricted terrain, this procedure becomes harder; however, constantly check the map as you move since it is the determining factor (Figure 11-5).

b. **Comparing the Vegetation Depicted on the Map.** When comparing the vegetation, a topographic map should be used to make a comparison of the clearings that appear on the map with the ones on the ground. The user must be familiar with the different symbols, such as vineyards, plantations, and orchards that appear on the legend. The age of the map is an important factor when comparing vegetation. Some important vegetation features were likely to be different when the map was made. Another important factor about vegetation is that it can change overnight by natural accidents or by man (forest fires, clearing of land for new developments, farming, and so forth).

c. **Masking by the Vegetation.** Camouflage the important landforms using vegetation. Use of camouflage makes it harder for the navigator to use terrain association.

d. **Using the Hydrography.** Inland bodies of water can help during terrain association. The shape and size of lakes in conjunction with the size and direction of flow of the rivers and streams are valuable help.

e. **Using Man-made Features.** Man-made features are an important factor during terrain association. The user must be familiar with the

symbols shown in the legend representing those features. The direction of buildings, roads, bridges, high-tension lines, and so forth make the terrain inspection a lot easier; however, the age of the map must be considered because man-made features appear and disappear constantly.

**f. Examining the Same Piece of Terrain During the Different Seasons of the Year.** In those areas of the world where the seasons are distinctive, a detailed examination of the terrain should be made during each of the seasons. The same piece of land does not present the same characteristics during both spring and winter.

(1) During winter, the snow packs the vegetation, delineating the land, making the terrain features appear as clear as they are shown by the contour lines on the map. Ridges, valleys, and saddles are very distinctive.

(2) During spring, the vegetation begins to reappear and grow. New vegetation causes a gradual change of the land to the point that the foliage conceals the terrain features and makes the terrain hard to recognize.

(3) During summer months, the effects are similar to those in the spring.

(4) Fall makes the land appear different with its change of color and gradual loss of vegetation.

(5) During the rainy season, the vegetation is green and thick, and the streams and ponds look like small rivers and lakes. In scarcely vegetated areas, the erosion changes the shape of the land.

(6) During a period of drought, the vegetation dries out and becomes vulnerable to forest fires that change the terrain whenever they occur. Also during this season, the water levels of streams and lakes drop, adding new dimensions and shape to the existing mapped areas.

**g. Following an Example of Terrain Association.** Your location is hilltop 514 in the lower center of the map in [Figure 11-7](#).



**Figure 11-7. Example of terrain association.**

(1) **To The North.** The contour lines indicate that the hill slopes down for about 190 meters, and that it leads into a small valley containing an intermittent stream. On the other side of the stream as you continue with your northerly inspection, the terrain starts a gradual ascent, indicating a hilltop partially covered with vegetation, until an unimproved road is reached. This road runs along a gradual ridgeline with north-west direction. Then the contour line spacings become narrow, indicating a steeper grade that leads to a narrow valley containing a small intermittent stream. As you continue up, you find a small but prominent ridge with a clearing. The contour lines once again show a steeper grade leading to a moderate valley containing an intermittent stream running in a south-east direction.

(2) **To The East.** There is a clearing of the terrain as it slopes down to Schley Pond. An ample valley is clearly seen on the right side of the pond, as indicated by the "U" and "V" shape of the contour lines. This valley contains some swamp areas and there is a long ridgeline on the north portion of the valley.

(3) **To The South.** The terrain gently slopes downward until a clear area is reached. It continues in a downward direction to an intermittent stream running south-east in a small valley. There is also an improved road running in the same direction as the valley. At the intersection of the roads as you face south, there is a clearing of about 120 meters on the ridge. At the bottom of it, a stream runs from Schley Pond in a south-west direction through an ample valley fed by two intermittent streams. As you continue, a steep, vegetated hill is found with a clearing on its top, followed by a small saddle and another hilltop.

(4) **To The West.** First, you see a small, clear valley. It is followed by a general ridgeline running north-west in which an unimproved road is located just before a hilltop. Continuing on a

westerly direction, you will find a series of alternate valleys and ridges.

[Back to Terrain Association](#)

Check out the **Amazon Coupons** before you buy.

Copyright © 2001-2002 Jalic LLC. All Rights Reserved.

[Disclaimer](#) | [Privacy Policy](#) | [Contact Us](#)



**Orienteering Home**

**The Sport:**

- **Orienteering History**
- **Orienteering**

**Overview**

- **Course Setup**
- **Officials**
- **Start/Finish Areas**
- **Course Safety**
- **Control Point**

**Guidelines**

- **Map Symbols**
- **Orienteering**

**Techniques**

- **Civilian Orienteering**

**The Skills:**

- **Maps**
- **Marginal Information and Symbols**

- **Grids**
- **Scale and Distance**
- **Direction**
- **Overlays**

- **Aerial Photographs**
- **Navigation**

**Equipment and Methods**

- **Elevation and Relief**
- **Terrain Association**
- **Navigation in**

**Different Types of Terrain**

- **Field Sketching**
- **Map Folding**

**Techniques**

- **Units of Measure and Conversion Factors**

## Movement and Route Selection

One key to success in tactical missions is the ability to move undetected to the objective. There are four steps to land navigation. Being given an objective and the requirement to move there, you must know where you are, plan the route, stay on the route, and recognize the objective.

a. **Know Where You Are (Step 1).** You must know where you are on the map and on the ground at all times and in every possible way. This includes knowing where you are relative to—

- Your directional orientation.
- The direction and distances to your objective.
- Other landmarks and features.
- Any impassable terrain, the enemy, and danger areas.
- Both the advantages and disadvantages presented by the terrain between you and your objective.

This step is accomplished by knowing how to read a map, recognize and identify specific terrain and other features; determine and estimate direction; pace, measure, and estimate distances, and both plot and estimate a position by resection.

b. **Plan the Route (Step 2).** Depending upon the size of the unit and the length and type of movement to be conducted, several factors should be considered in selecting a good route or routes to be followed. These include—

- Travel time.
- Travel distance.
- Maneuver room needed.
- Trafficability.
- Load-bearing capacities of the soil.



- Energy expenditure by troops.
- The factors of METT-T.
- Tactical aspects of terrain (OCOKA).
- Ease of logistical support.
- Potential for surprising the enemy.
- Availability of control and coordination features.
- Availability of good checkpoints and steering marks.

In other words, the route must be the result of careful map study and should address the requirements of the mission, tactical situation, and time available. It must also provide for ease of movement and navigation.

(1) Three route-selection criteria that are important for small-unit movements are cover, concealment, and the availability of reliable checkpoint features. The latter is weighted even more heavily when selecting the route for a night operation. The degree of visibility and ease of recognition (visual effect) are the key to the proper selection of these features.

(2) The best checkpoints are linear features that cross the route. Examples include perennial streams, hard-top roads, ridges, valleys, railroads, and power transmission lines. Next, it is best to select features that represent elevation changes of at least two contour intervals such as hills, depressions, spurs, and draws. Primary reliance upon cultural features and vegetation is cautioned against because they are most likely to have changed since the map was last revised.

(3) Checkpoints located at places where changes in direction are made mark your **decision points**. Be especially alert to see and recognize these features during movement. During preparation and planning, it is especially important to review the route and anticipate where mistakes are most likely to be made so they can be avoided.

(4) Following a valley floor or proceeding near (not on) the crest of a ridgeline generally offers easy movement, good navigation checkpoints, and sufficient cover and concealment. It is best to follow terrain features whenever you can—not to fight them.

(5) A lost or a late arriving unit, or a tired unit that is tasked with an unnecessarily difficult move, does not contribute to the accomplishment of a mission. On the other hand, the unit that moves too quickly and carelessly into a destructive ambush or leaves itself open to air strikes also have little effect. Careful planning and study are required each time a movement route is to be selected.

c. **Stay on the Route (Step 3).** In order to know that you are still on the correct route, you must be able to compare the evidence you encounter as you move according to the plan you developed on the map when you selected your route. This may include watching your compass reading (dead reckoning) or recognizing various checkpoints or landmarks from the map in their anticipated positions and sequences as you pass them (terrain association). A better way is to use a combination of both.

d. **Recognize the Objective (Step 4).** The destination is rarely a highly recognizable feature such as a dominant hilltop or road junction. Such locations as this are seldom missed by the most inexperienced navigators and are often dangerous places for soldiers to occupy. The relatively small, obscure places are most likely to be the destinations.

(1) Just how does a soldier travel over unfamiliar terrain for moderate to great distances and know when he reaches the destination? One minor error, when many are possible, can cause the target to be missed.

(2) The answer is simple. Select a checkpoint (reasonably close to the destination) that is not so difficult to find or recognize. Then plan a short, fine-tuned last leg from the new *expanded objective* to the final destination. For example, you may be able to plan and execute the move as a series of sequenced movements from one checkpoint or landmark to another using both the terrain and a compass to keep you on the correct course. Finally, after arriving at the last checkpoint, you might follow a specific compass azimuth and pace off the relatively short, known distance to the final, pinpoint destination. This procedure is called *point navigation*. A short movement out from a unit position to an observation post or to a coordination point may also be accomplished in the same manner.

[Back to Terrain Association](#)

Check out the **Amazon Coupons** before you buy.

Copyright © 2001-2002 Jalic LLC. All Rights Reserved.

[Disclaimer](#) | [Privacy Policy](#) | [Contact Us](#)



[Orienteering Home](#)

## Navigation Methods

### The Sport:

- [Orienteering History](#)
- [Orienteering](#)

### Overview

- [Course Setup](#)
- [Officials](#)
- [Start/Finish Areas](#)
- [Course Safety](#)
- [Control Point](#)

### Guidelines

- [Map Symbols](#)
- [Orienteering](#)

### Techniques

- [Civilian Orienteering](#)

### The Skills:

- [Maps](#)
- [Marginal Information and Symbols](#)
- [Grids](#)
- [Scale and Distance](#)
- [Direction](#)
- [Overlays](#)
- [Aerial Photographs](#)
- [Navigation](#)

### Equipment and

### Methods

- [Elevation and Relief](#)
- [Terrain Association](#)
- [Navigation in](#)

### Different Types of Terrain

- [Field Sketching](#)
- [Map Folding](#)

### Techniques

- [Units of Measure and Conversion Factors](#)

Staying on the route is accomplished through the use of one or two navigation techniques—dead reckoning and terrain association. These methods are discussed in detail below.

- a. **Moving by Dead Reckoning.** Dead reckoning consists of two fundamental steps. The first is the use of a protractor and graphic scales to determine the direction and distance from one point to another on a map. The second step is the use of a compass and some means of measuring distance to apply this information on the ground. In other words, it begins with the determination of a polar coordinate on a map and ends with the act of finding it on the ground.

- (1) Dead reckoning along a given route is the application of the same process used by a mapmaker as he establishes a measured line of reference upon which to construct the framework of his map. Therefore, triangulation exercises (either resection or intersection) can be easily undertaken by the navigator at any time to either determine or confirm precise locations along or near his route. Between these position-fixes, establish your location by measuring or estimating the distance traveled along the azimuth being followed from the previous known point. You might use pacing, a vehicle odometer, or the application of elapsed time for this purpose, depending upon the situation.

- (2) Most dead reckoned movements do not consist of single straight-line distances because you cannot ignore the tactical and navigational aspects of the terrain, enemy situation, natural and man-made obstacles, time, and safety factors. Another reason most dead reckoning movements are not single straight-line distances is because compasses and pace-counts are imprecise measures. Error from them compounds over distance; therefore, you could soon be far afield from your intended route even if you performed the procedures correctly. The only way to counteract this phenomenon is to reconfirm your location by terrain association or resection. Routes planned for dead reckoning generally consist of a series of straight-line distances between several checkpoints with perhaps some travel running on or parallel to roads or trails.

- (3) There are two advantages to dead reckoning. First, dead reckoning is easy to teach and to learn. Second, it can be a highly accurate way of moving from one point to another if done

carefully over short distances, even where few external cues are present to guide the movements.

(4) During daylight, across open country, along a specified magnetic azimuth, never walk with the compass in the open position and in front of you. Because the compass will not stay steady or level, it does not give an accurate reading when held or used this way. Begin at the start point and face with the compass in the proper direction, then sight in on a landmark that is located on the correct azimuth to be followed. Close the compass and proceed to that landmark. Repeat the process as many times as necessary to complete the straight-line segment of the route.

(5) The landmarks selected for this purpose are called *steering marks*, and their selection is crucial to success in dead reckoning. Steering marks should never be determined from a map study. They are selected as the march progresses and are commonly on or near the highest points that you can see along the azimuth line that you are following when they are selected. They may be uniquely shaped trees, rocks, hilltops, posts, towers, and buildings—anything that can be easily identified. If you do not see a good steering mark to the front, you might use a back azimuth to some feature behind you until a good steering mark appears out in front. Characteristics of a good steering mark are:

(a) It must have some characteristics about it, such as color, shade of color, size, or shape (preferably all four), that will assure you that it will continue to be recognized as you approach it.

(b) If several easily distinguished objects appear along your line of march, the best steering mark is the most distant object. This procedure enables you to travel farther with fewer references to the compass. If you have many options, select the highest object. A higher mark is not as easily lost to sight as is a lower mark that blends into the background as you approach it. A steering mark should be continuously visible as you move toward it.

(c) Steering marks selected at night must have even more unique shapes than those selected during daylight. As darkness approaches, colors disappear and objects appear as black or gray silhouettes. Instead of seeing shapes, you begin to see only the general outlines that may appear to change as you move and see the objects from slightly different angles.

(6) Dead reckoning without natural steering marks is used when the area through which you are traveling is devoid of features, or when visibility is poor. At night, it may be necessary to send a member of the unit out in front of your position to create your own steering mark in order to proceed. His position should be as far out as possible to reduce the number of chances for error as you move. Arm-and-hand signals or a radio may be used in placing him on the correct azimuth. After he has been properly located, move forward to his position and repeat the process until some steering

marks can be identified or until you reach your objective.

(7) When handling obstacles/detours on the route, follow these guidelines:

(a) When an obstacle forces you to leave your original line of march and take up a parallel one, always return to the original line as soon as the terrain or situation permits.

(b) To turn clockwise (right) 90 degrees, you must add 90 degrees to your original azimuth. To turn counterclockwise (left) 90 degrees from your current direction, you must subtract 90 degrees from your present azimuth.

(c) When making a detour, be certain that only paces taken toward the final destination are counted as part of your forward progress. They should not be confused with the local pacing that takes place perpendicular to the route in order to avoid the problem area and in returning to the original line of march after the obstacle has been passed.

(8) Sometimes a steering mark on your azimuth of travel can be seen across a swamp or some other obstacle to which you can simply walk out around. Dead reckoning can then begin at that point. If there is no obvious steering mark to be seen across the obstacle, perhaps one can be located to the rear. Compute a back azimuth to this point and later sight back to it once the obstacle has been passed in order to get back on track.

(9) You can use the deliberate offset technique. Highly accurate distance estimates and precision compass work may not be required if the destination or an intermediate checkpoint is located on or near a large linear feature that runs nearly perpendicular to your direction of travel. Examples include roads or highways, railroads, power transmission lines, ridges, or streams. In these cases, you should apply a deliberate error (offset) of about 10 degrees to the azimuth you planned to follow and then move, using the lensatic compass as a guide, in that direction until you encounter the linear feature. You will know exactly which way to turn (left or right) to find your destination or checkpoint, depending upon which way you planned your deliberate offset.

(10) Because no one can move along a given azimuth with absolute precision, it is better to plan a few extra steps than to begin an aimless search for the objective once you reach the linear feature. If you introduce your own mistake, you will certainly know how to correct it. This method will also cope with minor compass errors and the slight variations that always occur in the earth's magnetic field.

(11) There are disadvantages to dead reckoning. The farther you travel by dead reckoning without confirming your position in relation to the terrain and other features, the more errors you will accumulate in your movements. Therefore, you should confirm and correct your estimated position whenever you encounter a known feature on the ground that is also on the map. Periodically,



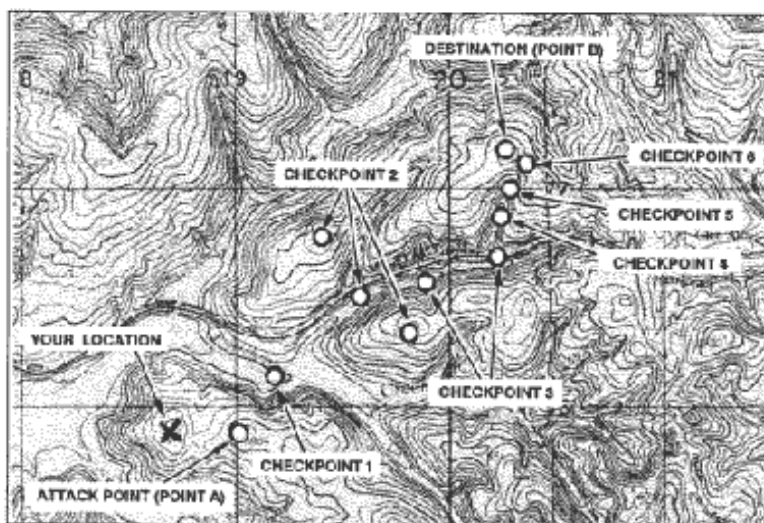
you should accomplish a resection triangulation using two or more known points to pinpoint and correct your position on the map. Pace counts or any type of distance measurement should begin anew each time your position is confirmed on the map.

(a) It is dangerous to select a single steering mark, such as a distant mountaintop, and then move blindly toward it. What will you do if you must suddenly call for fire support or a medical evacuation? You must periodically use resection and terrain association techniques to pinpoint your location along the way.

(b) Steering marks can be farther apart in open country, thereby making navigation more accurate. In areas of dense vegetation, however, where there is little relief, during darkness, or in fog, your steering marks must be close together. This, of course, introduces more chance for error.

(c) Finally, dead reckoning is time-consuming and demands constant attention to the compass. Errors accumulate easily and quickly. Every fold in the ground and detours as small as a single tree or boulder also complicate the measurement of distance.

**b. Moving by Terrain Association.** The technique of moving by terrain association is more forgiving of mistakes and far less time-consuming than dead reckoning. It best suits those situations that call for movement from one area to another. Once an error has been made in dead reckoning, you are off the track. Errors made using terrain association are easily corrected, however, because you are comparing what you expected to see from the map to what you do see on the ground. Errors are anticipated and will not go unchecked. You can easily make adjustments based upon what you encounter. After all, you do not find the neighborhood grocery store by dead reckoning—you adjust your movements according to the familiar landmarks you encounter along the way (Figure 11-8). Periodic position-fixing through either plotted or estimated resection will also make it possible to correct your movements, call for fire, or call in the locations of enemy targets or any other information of tactical or logistical importance.





**Figure 11-8. Terrain association navigation with a topographic map.**

(1) ***Identifying and Locating Selected Features.*** Being able to identify and locate the selected features, both on the map and on the ground, are essential to the success in moving by terrain association. The following rules may prove helpful.

(a) Be certain the map is properly oriented when moving along the route and use the terrain and other features as guides. The orientation of the map must match the terrain or it can cause confusion.

(b) To locate and identify features being used to guide the movement, look for the steepness and shape of the slopes, the relative elevations of the various features, and the directional orientations in relation to your position and to the position of the other features you can see.

(c) Make use of the additional cues provided by hydrography, culture, and vegetation. All the information you can gather will assist you in making the move. The ultimate test and the best practice for this movement technique is to go out in the field and use it. The use of terrain, other natural features, and any man-made objects that appear both on the map and on the ground must be practiced at every opportunity. There is no other way to learn or retain this skill.

(2) ***Using Handrails, Catching Features, and Navigational Attack Points.*** First, because it is difficult to dead reckon without error over long distances with your compass, the alert navigator can often gain assistance from the terrain.

(a) **Handrails** are linear features like roads or highways, railroads, power transmission lines, ridgelines, or streams that run roughly parallel to your direction of travel. Instead of using precision compass work, you can rough compass without the use of steering marks for as long as the feature travels with you on your right or left. It acts as a handrail to guide the way.

(b) Second, when you reach the point where either your route or the handrail changes direction, you must be aware that it is time to go your separate ways. Some prominent feature located near this point is selected to provide this warning. This is called a *catching feature*; it can also be used to tell you when you have gone too far.

(c) Third, the catching feature may also be your *navigational attack point*; this point is the place where area navigation ends and point navigation begins. From this last easily identified checkpoint, the navigator moves cautiously and precisely along a given azimuth for a specified distance to locate the final objective. The selection of this navigational attack point is important. A

distance of 500 meters or less is most desirable.

(3) ***Recognizing the Disadvantages of Terrain Association.*** The major disadvantage to navigation by terrain association is that you must be able to interpret the map and analyze the world around you. Recognition of terrain and other features, the ability to determine and estimate direction and distance, and knowing how to do quick-in-the-head position fixing are skills that are more difficult to teach, learn, and retain than those required for dead reckoning.

c. **Combination of Techniques.** Actually, the most successful navigation is obtained by combining the techniques described above. Constant orientation of the map and continuous observation of the terrain in conjunction with compass-read azimuths, and distance traveled on the ground compared with map distance, used together make reaching a destination more certain. One should not depend entirely on compass navigation or map navigation; either or both could be lost or destroyed.

[Back to Terrain Association](#)

Check out the **Amazon Coupons** before you buy.

Copyright © 2001-2002 Jalic LLC. All Rights Reserved.

**[Disclaimer](#) | [Privacy Policy](#) | [Contact Us](#)**



[Orienteering Home](#)

## Night Navigation

### The Sport:

- [Orienteering History](#)
- [Orienteering](#)

### Overview

- [Course Setup](#)
- [Officials](#)
- [Start/Finish Areas](#)
- [Course Safety](#)
- [Control Point](#)

### Guidelines

- [Map Symbols](#)
- [Orienteering](#)

### Techniques

- [Civilian Orienteering](#)

### The Skills:

- [Maps](#)
- [Marginal Information and Symbols](#)
- [Grids](#)
- [Scale and Distance](#)
- [Direction](#)
- [Overlays](#)
- [Aerial Photographs](#)
- [Navigation](#)

### Equipment and

### Methods

- [Elevation and Relief](#)
- [Terrain Association](#)
- [Navigation in](#)

### Different Types of Terrain

- [Field Sketching](#)
- [Map Folding](#)

### Techniques

- [Units of Measure and Conversion Factors](#)

Darkness presents its own characteristics for land navigation because of limited or no visibility. However, the techniques and principles are the same as that used for day navigation. The success in nighttime land navigation depends on rehearsals during the planning phase before the movement, such as detailed analysis of the map to determine the type of terrain in which the navigation is going to take place and the predetermination of azimuths and distances. Night vision devices can greatly enhance night navigation.

a. The basic technique used for nighttime land navigation is dead reckoning with several compasses recommended. The point man is in front of the navigator but just a few steps away for easy control of the azimuth. Smaller steps are taken during night navigation, so remember, the pace count is different. It is recommended that a pace count obtained by using a predetermined 100-meter pace course be used at night.

b. Navigation using the stars is recommended in some areas; however, a thorough knowledge of constellations and location of stars is needed. The four cardinal directions can also be obtained at night by using the same technique described for the shadow-tip method. Just use the moon instead of the sun. In this case, the moon has to be bright enough to cast a shadow.

[Back to Terrain Association](#)

Check out the [Amazon Coupons](#) before you buy.

Copyright © 2001-2002 Jalic LLC. All Rights Reserved.

[Disclaimer](#) | [Privacy Policy](#) | [Contact Us](#)





[Orienteering Home](#)

**The Sport:**

- [Orienteering History](#)
- [Orienteering Overview](#)

**Course Setup**

- [Course Setup](#)
- [Officials](#)
- [Start/Finish Areas](#)
- [Course Safety](#)
- [Control Point](#)

**Guidelines**

- [Map Symbols](#)
- [Orienteering Techniques](#)

**Techniques**

- [Civilian Orienteering](#)

**The Skills:**

- [Maps](#)
- [Marginal Information and Symbols](#)
- [Grids](#)
- [Scale and Distance](#)
- [Direction](#)
- [Overlays](#)
- [Aerial Photographs](#)
- [Navigation](#)

**Equipment and Methods**

- [Elevation and Relief](#)
- [Terrain Association](#)
- [Navigation in Different Types of Terrain](#)

**Field Sketching**

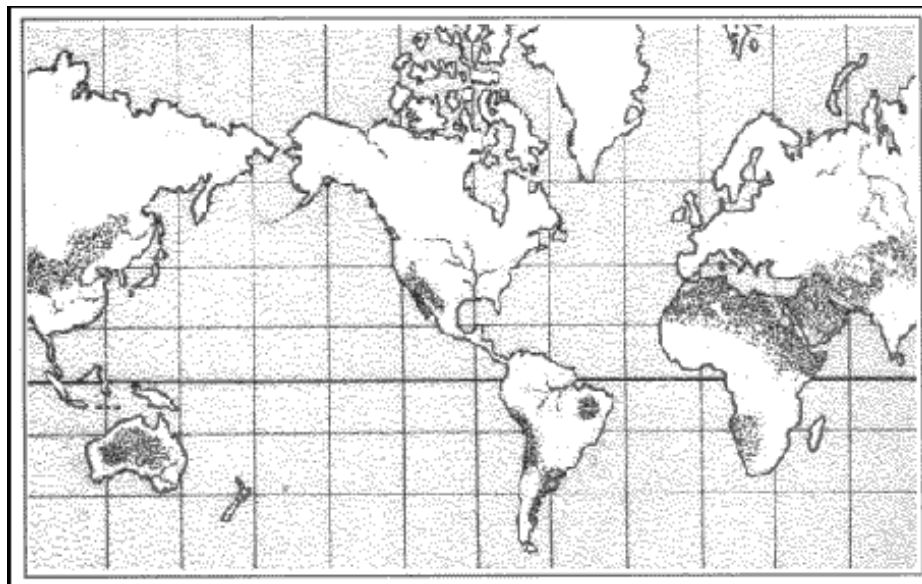
- [Field Sketching](#)
- [Map Folding](#)

**Techniques**

- [Units of Measure and Conversion Factors](#)

## Desert Terrain

About 5 percent of the earth's land surface is covered by deserts (Figure 13-1). Deserts are large arid areas with little or no rainfall during the year. There are three types of deserts—mountain, rocky plateau, and sandy or dune deserts. All types of forces can be deployed in the desert. Armor and mechanized infantry forces are especially suitable to desert combat except in rough mountainous terrain where light infantry may be required. Airborne, air assault, and motorized forces can also be advantageously employed to exploit the vast distances characteristic of desert warfare.



**Figure 13-1. Deserts.**

a. **Desert Regions.** In desert regions, terrain varies from nearly flat to lava beds and salt marshes. Mountain deserts contain scattered ranges or areas of barren hills or mountains. Table 13-1 lists some of the world's major desert regions and their locations.

Region	Location
Sahara	North Africa
Kalahari	Southwest Africa
Arabian	Southwest Asia

Gobi	Mongolia and Northern China
Rub'al Khali	South Arabia
Great Basin, Colorado, Chihuahua, Yuma Sonoran, and Mohave	Northern Mexico and Western United States
Takla Makan	Northern China
Kyzyl Kum	Southwest USSR
Kara Kum	Southwest USSR
Syrian	Saudi Arabia, Jordan, and Iraq
Great Victoria	Western and South Australia
Patagonia	Southern Argentina and Chile
Altacama	Northern Chile

**Table 13-1. Major desert regions.**

(1) Finding the way in a desert presents some degree of difficulty for a person who has never been exposed to this environment. Desert navigators have learned their way through generations of experience.

(2) Normally, desert people are nomadic, constantly moving in caravans. Navigating becomes second nature to them. Temperature in the tropical deserts reaches an average of 110° to 115° during the day, so most navigation takes place at night using the stars. Most deserts have some prevailing winds during the seasons. Such winds arrange the sand dunes in a specific pattern that gives the navigator the opportunity to determine the four cardinal directions. He may also use the sun's shadow-tip method.

(3) A sense of direction can be obtained by watching desert animals on their way to and from water holes (oases). Water, navigation, and survival are closely related in desert areas. Most deserts have pigeons or doves, and their drinking habits are important to the navigator. As a rule, these birds never drink in the morning or during the day, making their evening flights the most important. When returning from the oases, their bodies are heavier from drinking and their flight is accompanied by a louder flapping of their wings.

(4) Visibility is also an important factor in the desert, especially in judging distance. The absence of trees or other features prevents comparison between the horizon and the skyline.

**b. Interpretation and Analysis.** Many desert maps are inaccurate, which makes up-to-date air, aerial photo, and ground reconnaissance necessary. In desert mountain areas contour intervals are generally large,



so many of the intermediate relief features are not shown.

(1) The desert normally permits observation and fire to maximum ranges. The terrain is generally wide open and the exceptionally clear atmosphere offers excellent long-range visibility. Combine this with a powerful sun and low cloud density and you have nearly unlimited light and visual clarity, which often contribute to gross underestimations of ranges. Errors of up to 200 or 300 percent are not uncommon. However, visibility conditions may be severely affected by sandstorms and mirages (heat shimmer caused by air rising from the extremely hot daytime desert surface), especially if the observer is looking into the sun through magnifying optical instruments.

(2) Cover can be provided only by terrain feature masking because of the lack of heavy vegetation and man-made objects. It only takes a few meters of relief to provide cover. Concealment in the desert is related to the following factors:

(a) *Shape*. In order not to be observed by the enemy, attempt to alter the standard shapes of vehicles so they and their shadows are not instantly recognized.

(b) *Shine*. Shine or glitter is often the first thing that attracts the observer's eye to movement many kilometers away. It must be eliminated.

(c) *Color and texture*. All equipment should either be pattern painted or mudded to blend in with the terrain.

(d) *Light and noise*. Light and noise discipline are essential because sound and light travel great distances in the desert.

(e) *Heat*. Modern heat image technology makes shielding heat sources an important consideration when trying to hide from the enemy. This technology is especially important during night stops.

(f) *Movement*. Movement itself creates a great deal of noise and dust, but a rapid execution using all the advantages the topography offers can help conceal it.

c. *Navigation*. When operating in the broad basins between mountain ranges or on rocky plateau deserts, there are frequently many terrain features to guide your movement by. But, observing these known features over great distances may provide a false sense of security in determining your precise location unless you frequently confirm your location by resection or referencing close-in terrain features. It is not uncommon to develop errors of several kilometers when casually estimating a position in this manner. Obviously, this can create many problems when attempting to locate a small checkpoint or objective, calling for CAS, reporting operational or intelligence information, or meeting CSS requirements.

(1) When operating in an area with few visual cues, such as in a

sandy or dune desert, or restricted visibility by a sandstorm or darkness, you must proceed by dead reckoning. The four steps and two techniques for navigation presented earlier remain valid in the desert. However, understanding the special conditions found there are extremely helpful as you apply them.

(2) Tactical mobility and speed are key to successful desert operations. Obstacles and areas such as lava beds or salt marshes, which preclude surface movements, do exist. But most deserts permit two-dimensional movement by ground forces similar to that of a naval task force at sea. Speed of execution is essential. Everyone moves farther and faster on the desert. Special navigation aids sometimes used in the desert include:

(a) *Sun compass*. It can be used on moving vehicles and sextants. It requires accurate timekeeping. However, the deviation on a magnetic compass that is caused by the metal and electronics in the vehicle is usually less than  $+10^\circ$ .

(b) *Gyro compass*. The gun azimuth stabilizer is in fact a gyro compass. If used on fairly flat ground, it is useful for maintaining direction over limited distances.

(c) *Fires*. Planned tracer fire or mortar and artillery concentrations (preferably smoke during the day and illumination at night) provide useful checks on estimated locations.

(d) *Prepositioned lights*. This method consists of placing two or more searchlights far apart, behind the line of contact, beyond enemy artillery range, and concealed from enemy ground observation. Units in the area can determine their own locations through resection, using the vertical beams of the lights. These lights must be moved on a time schedule known to all friendly units.

(3) One final note on desert navigation is that the sand, hard-baked ground, rocky surfaces, thorny vegetation, and heat generally found in the desert impose far greater demands for maintenance than you would plan for in temperate regions. It may also take longer to perform that maintenance.

[Back to Navigation in Different Types of Terrain](#)

Check out the **Amazon Coupons** before you buy.

Copyright © 2001-2002 Jalic LLC. All Rights Reserved.

[Disclaimer](#) | [Privacy Policy](#) | [Contact Us](#)



[Orienteering Home](#)

**The Sport:**

- [Orienteering History](#)
- [Orienteering Overview](#)

**Course Setup**

- [Course Setup](#)
- [Officials](#)
- [Start/Finish Areas](#)
- [Course Safety](#)
- [Control Point](#)

**Guidelines**

- [Map Symbols](#)
- [Orienteering Techniques](#)

**Techniques**

- [Civilian Orienteering](#)

**The Skills:**

- [Maps](#)
- [Marginal Information and Symbols](#)
- [Grids](#)
- [Scale and Distance](#)
- [Direction](#)
- [Overlays](#)
- [Aerial Photographs](#)
- [Navigation](#)

**Equipment and Methods**

- [Elevation and Relief](#)
- [Terrain Association](#)
- [Navigation in Different Types of Terrain](#)

**Different Types of Terrain**

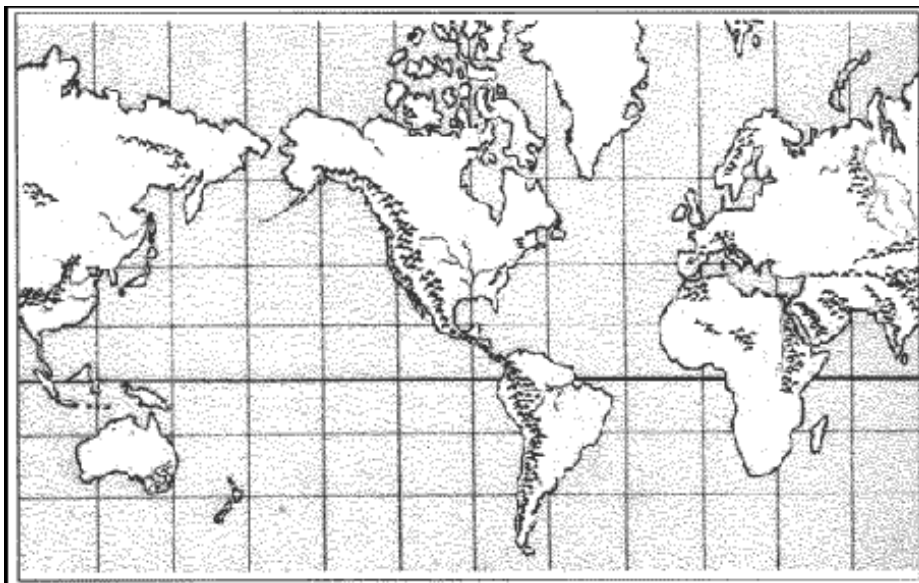
- [Field Sketching](#)
- [Map Folding](#)

**Techniques**

- [Units of Measure and Conversion Factors](#)

## Mountain Terrain

Mountains are generally understood to be larger than hills. Rarely do mountains occur individually; in most cases, they are found in elongated ranges or circular groups. When they are linked together, they constitute a mountain system (Figure 13-2). Light forces (infantry, airborne, and air assault forces) can operate effectively in mountainous regions because they are not terrain limited. Heavy forces must operate in passes and valleys that are negotiable by vehicle.



**Figure 13-2. Mountain systems.**

a. **Major Systems.** Major systems are listed in Table 13-2.

System	Location
The Andes	Central and South America
The Rockies	North America (USA-Canada)
The Appalachians	North America (USA-Canada)
The Alps	Central Europe
The Himalayas	Asia
The Caucasus	Western Asia and Europe (Russia)

**Table 13-2. Major systems.**

b. **Minor Systems.** Some other systems are in Antarctica, Hawaii,

Japan, New Zealand, and Oceania. Mountain systems are characterized by high, inaccessible peaks and steep slopes. Depending on the altitude, they may be snow covered. Prominent ridges and large valleys are also found. Navigating in this type of terrain is not difficult providing you make a careful examination of the map and the terrain.

c. **Climate.** Because of the elevations, it is always colder ( $3^{\circ}$  to  $5^{\circ}$  per 300-meter gain in altitude) and wetter than you might expect. Wind speeds can increase the effects of the cold even more. Sudden severe storms and fog are encountered regularly. Below the tree line, vegetation is heavy because of the extra rainfall and the fact that the land is rarely cleared for farming.

d. **Interpretation and Analysis.** The heights of mountainous terrain permit excellent long-range observation. However, rapidly fluctuating weather with frequent periods of high winds, rain, snow, or fog may limit visibility. Also, the rugged nature of the terrain frequently produces significant dead space at mid-ranges.

(1) Reduced mobility, compartmented terrain, and the effects of rapidly changing weather increase the importance of air, ground, aerial photo, and map reconnaissance. Since mountain maps often use large contour intervals, microrelief interpretation and detailed terrain analysis require special emphasis.

(2) At first glance, some mountainous terrain may not appear to offer adequate cover and concealment; however, you can improve the situation. When moving, use rock outcroppings, boulders, and heavy vegetation for cover and concealment; use terrain features to mask maneuvers. Use harsh weather, which often obscures observation, to enhance concealment.

(3) Since there are only a few routing options, all-round security must be of primary concern. Natural obstacles are everywhere, and the enemy can easily construct more.

e. **Navigation.** Existing roads and trails offer the best routes for movement. Off-road movement may enhance security provided there is detailed reconnaissance, photo intelligence, or information from local inhabitants to ensure the route is negotiable. Again, the four steps and two techniques for navigation presented earlier remain valid in the mountains. Nevertheless, understanding the special conditions and the terrain will help you navigate. Other techniques that are sometimes helpful in mountains are:

(1) **Aspect of Slope.** To determine the aspect of slope, take a compass reading along an imaginary line that runs straight down the slope. It should cut through each of the contour lines at about a  $90^{\circ}$  angle. By checking the map and knowing the direction of slope where you are located, you will be able to keep track of your location, and it will help guide your cross-country movement even when visibility is poor.

(2) **Use of an Altimeter.** Employment of an altimeter with calibrations on the scale down to 10 or 20 meters is helpful to land navigators moving in areas where radical changes in elevation

exist. An altimeter is a type of barometer that gauges air pressure, except it measures on an adjustable scale marked in feet or meters of elevation rather than in inches or centimeters of mercury. Careful use of the altimeter helps to pinpoint your position on a map through a unique type of resection. Instead of finding your position by using two different directional values, you use one directional value and one elevation value.

## [Back to Navigation in Different Types of Terrain](#)

Check out the **Amazon Coupons** before you buy.

Copyright © 2001-2002 Jalic LLC. All Rights Reserved.

**[Disclaimer](#) | [Privacy Policy](#) | [Contact Us](#)**





[Orienteering Home](#)

**The Sport:**

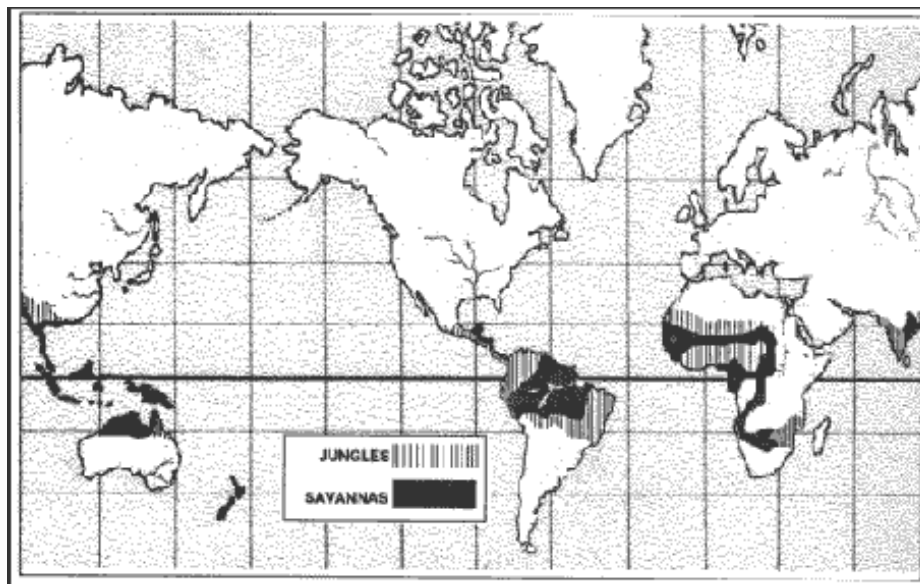
- [Orienteering History](#)
- [Orienteering Overview](#)
- [Course Setup](#)
- [Officials](#)
- [Start/Finish Areas](#)
- [Course Safety](#)
- [Control Point](#)
- [Guidelines](#)
- [Map Symbols](#)
- [Orienteering Techniques](#)
- [Civilian Orienteering](#)

**The Skills:**

- [Maps](#)
- [Marginal Information and Symbols](#)
- [Grids](#)
- [Scale and Distance](#)
- [Direction](#)
- [Overlays](#)
- [Aerial Photographs](#)
- [Navigation](#)
- [Equipment and Methods](#)
- [Elevation and Relief](#)
- [Terrain Association](#)
- [Navigation in Different Types of Terrain](#)
- [Field Sketching](#)
- [Map Folding](#)
- [Techniques](#)
- [Units of Measure and Conversion Factors](#)

## Jungle Terrain

These large geographic regions are found within the tropics near the equator (Central America, along the Amazon River, South-Eastern Asia and adjacent islands, and vast areas in the middle of Africa and India) (Figure 13-3). Jungles are characterized as rainy, humid areas with heavy layers of tangled, impenetrable vegetation. Jungles contain many species of wildlife (tigers, monkeys, parrots, snakes, alligators, and so forth). The jungle is also a paradise for insects, which are the worst enemy of the navigator because some insects carry diseases (malaria, yellow fever, cholera, and so forth). While navigating in these areas, very little terrain association can be accomplished because of the heavy foliage. Dead reckoning is one of the methods used in these areas. A lost navigator in the jungle can eventually find his way back to civilization by following any body of water with a downstream flow. However, not every civilization found is of a friendly nature.



**Figure 13-3. Jungles and savannas.**

- a. **Operations.** Operations in jungles tend to be isolated actions by small forces because of the difficulties encountered in moving and in maintaining contact between units. Divisions can move cross-country slowly; but, aggressive reconnaissance, meticulous intelligence collection, and detailed coordination are required to concentrate forces in this way. More commonly, large forces operate along roads or natural avenues of movement, as was the case in the mountains. Patrolling and



other surveillance operations are especially important to ensure security of larger forces in the close terrain of jungles.

(1) Short fields of observation and fire, and thick vegetation make maintaining contact with the enemy difficult. The same factors reduce the effectiveness of indirect fire and make jungle combat primarily a fight between infantry forces. Support by air and mechanized forces can be decisive at times, but it will not always be available or effective.

(2) Jungles are characterized by high temperatures, heavy rains, high humidity, and an abundance of vegetation. The climate varies with location. Close to the equator, all seasons are nearly alike with heavy rains all year. Farther from the equator (India and Southeast Asia), there are distinct wet (monsoon) and dry seasons. Both zones have high temperatures (averaging 75 to 95+ degrees Fahrenheit), heavy rainfall (as much as 400+ inches annually, and high humidity (90 percent) all year.

(3) In temperate climates, it is the areas of vegetation that are most likely to be altered and incorrectly portrayed on a map. In jungle areas, the vegetation grows so rapidly that it is more likely to be cleared and make these areas be shown incorrectly.

**b. Interpretation and Analysis.** The jungle environment includes dense forests, grasslands, swamps, and cultivated areas. Forests are classified as primary and secondary based upon the terrain and vegetation. Primary forests include tropical rain forests and deciduous forests. Secondary forests are found at the edges of both rain forests and deciduous forests and in areas where jungles have been cleared and abandoned. These places are typically overgrown with weeds, grasses, thorns, ferns, canes, and shrubs. Movement is especially slow and difficult. The extremely thick vegetation reaches a height of 2 meters and severely limits observation to only a few meters.

(1) Tropical rain forests consist mostly of large trees whose branches spread and lock together to form canopies. These canopies, which can exist at two and three different levels, may form as low as 10 meters from the ground. They prevent direct sunlight from reaching the ground, causing a lack of undergrowth on the jungle floor. Extensive above-ground root systems and hanging vines are common and make vehicular travel difficult; foot movement is easier. Ground observation is limited to about 50 meters and air observation is nearly impossible.

(2) Deciduous forests are in semitropical zones that have both wet and dry seasons. In the wet season, trees are fully leaved; in the dry season, much of the foliage dies. Trees are usually less dense than in rain forests, which allows more sunlight to filter to the ground. This procedure produces thick undergrowth. During the wet season, air and ground observation is limited and movement is difficult. During the dry season, both improve.

(3) Swamps are common to all low, jungle areas where there is poor drainage. When navigating in a swampy area, a careful analysis of map and ground should be taken before any movement.

The soldiers should travel in small numbers with only the equipment required for their mission, keeping in mind that they are going to be immersed in water part of the time. The usual technique used in swamp navigation is dead reckoning. There are two basic types of swamps—mangrove and palm. Mangrove swamps are found in coastal areas wherever tides influence water flow. Mangrove is a shrub-like tree that grows 1 to 5 meters high. These trees have a tangled root system, both above and below the waterline, which restricts movement either by foot or small boat. Observation on the ground and from the air is poor, but concealment is excellent.

(4) Grassy plains or savannas are generally located away from the equator but within the tropics. These vast land areas are characterized by flatlands with a different type of vegetation than jungles. They consist mainly of grasses (ranging from 1 to more than 12 feet in height), shrubs, and isolated trees. The most difficult areas to navigate are the ones surrounded by tall grass (elephant grass); however, vehicles can negotiate here better than in some areas. There are few or no natural features to navigate by, making dead reckoning or navigation by stars the only technique for movement (Figure 13-3). Depending on the height of the grass, ground observation may vary from poor to good. Concealment from air observation is poor for both soldiers and vehicles.

(5) Bamboo stands are common throughout the tropics. They should be bypassed whenever possible. They are formidable obstacles for vehicles, and soldier movement through them is slow, exhausting, and noisy.

(6) Cultivated areas exist in jungles also. They range from large, well-planned, well-managed farms and plantations to small tracts, cultivated by farmers. The three general types of cultivated areas are rice paddies, plantations, and small farms.

c. **Navigation.** Areas such as jungles are generally not accurately mapped because heavy vegetation makes aerial surveys difficult. The ability to observe terrain features, near or far, is extremely limited. The navigator must rely heavily upon his compass and the dead reckoning technique when moving in the jungle. Navigation is further complicated by the inability to make straight-line movements. Terrain analysis, constant use of the compass, and an accurate pace count are essential to navigation in this environment.

(1) Rates of movement and pace counts are particularly important to jungle navigators. The most common error is to overestimate the distance traveled. The distances below can be used as a rough guide for the maximum distances that might be traveled in various types of terrain during one hour in daylight.

Type of Terrain	Maximum Distance (In Meters)
Tropical Rain Forest	Up to 1,000
Deciduous Forest	500
Secondary jungle	100 to 500
Tall Grass	500

Swamps	100 to 300
Rice paddies (wet)	800
Rice paddies (dry)	2,000
Plantations	2,000
Trails	up to 3,000

**Table 13-3. Guide for maximum distance.**

(2) Special navigation strategies that are helpful in jungles include:

(a) Personal pace table. You should either make a mental or written personal pace table that includes your average pace count per 100 meters for each of the types of terrain through which you are likely to navigate.

(b) Resection using indirect fire. Call for mortar or artillery fire (airbursts of white phosphorous or illumination) on two widely separated grids that are not on terrain features like the one you are occupying and are a safe distance from your estimated location. Directions to the airbursts sometimes must be determined by sound.

(c) Modified area/point navigation. Even when making primary use of the compass for dead reckoning, you are frequently able to area navigate to an expanded objective, which is easily identified by terrain association. Then, simply develop a short, point-navigation leg to your final destination.

## Back to Navigation in Different Types of Terrain

Check out the **Amazon Coupons** before you buy.

Copyright © 2001-2002 Jalic LLC. All Rights Reserved.

**Disclaimer | Privacy Policy | Contact Us**



[Orienteering Home](#)

The Sport:

- [Orienteering History](#)
- [Orienteering](#)

Overview

- [Course Setup](#)
- [Officials](#)
- [Start/Finish Areas](#)
- [Course Safety](#)
- [Control Point](#)

Guidelines

- [Map Symbols](#)
- [Orienteering](#)

Techniques

- [Civilian Orienteering](#)

The Skills:

- [Maps](#)
- [Marginal Information and Symbols](#)
- [Grids](#)
- [Scale and Distance](#)
- [Direction](#)
- [Overlays](#)
- [Aerial Photographs](#)
- [Navigation](#)

Equipment and

Methods

- [Elevation and Relief](#)
- [Terrain Association](#)
- [Navigation in](#)

Different Types of Terrain

- [Field Sketching](#)
- [Map Folding](#)

Techniques

- [Units of Measure and Conversion Factors](#)

## Arctic Terrain

Arctic terrain includes those areas that experience extended periods of below freezing temperatures. In these areas, the ground is generally covered with ice or snow during the winter season. Although frozen ground and ice can improve trafficability, a deep accumulation of snow can reduce it. Vehicles and personnel require special equipment and care under these adverse conditions.

a. **Operations.** Both the terrain and the type and size of unit operations vary greatly in arctic areas. In open terrain, armored and mechanized forces will be effective although they will have to plan and train for the special conditions. In broken terrain, forests, and mountains, light forces will predominate as usual. However, foot movement can take up to five times as long as it might under warmer conditions.

b. **Interpretation and Analysis.** Both the terrain and cultural features you may confront in winter may vary to any extreme, as can the weather. The common factor is an extended period of below-freezing temperatures. The terrain may be plains, plateaus, hills, or mountains. The climate will be cold, but the weather will vary greatly from place to place. Most arctic terrain experiences snow, but some claim impressive accumulations each season, such as the lake-effected snow belts off Lake Ontario near Fort Drum, New York. Other areas have many cold days with sunshine and clear nights, and little snow accumulation.

(1) In areas with distinct local relief and scattered trees or forests, the absence of foliage makes movement by terrain association easier; observation and fields of fire are greatly enhanced except during snowstorms. But in relatively flat, open areas covered with snow (especially in bright sunlight), the resulting lack of contrast may interfere with your being able to read the land. With foliage gone, concealment (both from the ground and from the air) is greatly reduced. As in desert areas, you must make better use of the terrain to conceal your movements.

(2) Frozen streams and swamps may no longer be obstacles, and thus identification of avenues of approach may be difficult in winter. However, the concept as to what is key terrain is not likely to be affected.

c. **Navigation.** Special skills may be required in arctic terrain, such as the proper use of winter clothing, skis, and snowshoes; but this does not

affect your navigation strategies. There are no special techniques for navigating in arctic terrain. Just be aware of the advantages and disadvantages that may present themselves and make the most of your opportunities while applying the four steps and two techniques for land navigation.

(1) Remember, the highest caliber of leadership is required to ensure that all necessary tasks are performed, that security is maintained, and that soldiers and their equipment are protected from the physical effects of very low temperatures. There is a great temptation to do less than a thorough job at whatever the task may be when you are very cold.

(2) Night navigation may be particularly enhanced when operating in arctic terrain. Moonlight and starlight on a clear night reflect off the snow, thus enabling you to employ daytime terrain association techniques with little difficulty. Even cloudy winter nights are often brighter than clear moonlit summer nights when the ground is dark and covered with foliage. Movements with complete light discipline (no black-out drives) can often be executed. On the other hand, areas with severe winter climates experience lengthy periods of darkness each day, which may be accompanied by driving snow and limited visibility.

[Back to Navigation in Different Types of Terrain](#)

Check out the [Amazon Coupons](#) before you buy.

Copyright © 2001-2002 Jalic LLC. All Rights Reserved.

[Disclaimer](#) | [Privacy Policy](#) | [Contact Us](#)